

TBI



Tall Buildings Initiative

Guidelines for Performance- Based Seismic Design of Tall Buildings

Version 1.0

November 2010

Developed by
Pacific Earthquake Engineering Research Center
Report No. 2010/05

Sponsored by
Charles Pankow Foundation
California Seismic Safety Commission
California Emergency Management Agency
Los Angeles Department of Building and Safety



PEER

Disclaimer

These Guidelines are intended to provide a reliable basis for the seismic design of tall buildings based on the present state of knowledge, laboratory and analytical research, and the engineering judgments of persons with substantial knowledge in the design and seismic behavior of tall buildings. When properly implemented, these Guidelines should permit design of tall buildings that are capable of seismic performance equivalent or superior to that attainable by design in accordance with present prescriptive Building Code provisions. Earthquake engineering is a rapidly developing field and it is likely that knowledge gained in the future will suggest that some recommendations presented herein should be modified. Individual engineers and building officials implementing these Guidelines must exercise their own independent judgments as to the suitability of these recommendations for that purpose. The Pacific Earthquake Engineering Research Center, the University of California, the Charles Pankow Foundation, the California Seismic Safety Commission, other project funding agencies, and the individual contributors to this document and their employers offer no warranty, either expressed or implied, as to the suitability of these Guidelines for application to individual building projects.

Cover image credit after Pelli Clarke Pelli, project architect. Rendering courtesy of the Transbay Joint Powers Authority.

Guidelines for Performance-Based Seismic Design of Tall Buildings

Developed by the
Pacific Earthquake Engineering Research Center (PEER)
as part of the
Tall Buildings Initiative

Report No. 2010/05
Pacific Earthquake Engineering Research Center
College of Engineering
University of California, Berkeley
November 2010

GUIDELINES FOR PERFORMANCE-BASED SEISMIC DESIGN OF TALL BUILDINGS*

Prepared by the TBI Guidelines Working Group

Yousef Bozorgnia, Ph.D., P.E.
Executive Director
Pacific Earthquake Engineering Research
Center

C.B. Crouse, Ph.D., G.E.
Principal Engineer/Vice President
URS Consultants, Inc.

Ronald O. Hamburger, S.E. (Chair)
Senior Principal
Simpson Gumpertz & Heger, Inc.

Ronald Klemencic, S.E.
President
Magnusson Klemencic Associates, Inc.

Helmut Krawinkler, Ph.D., P.E.
Professor Emeritus
Stanford University

James O. Malley, S.E.
Senior Principal
Degenkolb Engineers, Inc.

Jack P. Moehle, Ph.D., P.E. (Co-Chair)
Professor
University of California, Berkeley

Farzad Naeim, Ph.D., S.E.
Vice President & General Counsel
John A. Martin & Associates, Inc.

Jonathan P. Stewart, Ph.D., P.E.
Professor
University of California at Los Angeles

* How to Cite This Publication: *Guidelines for Performance-Based Seismic Design of Tall Buildings*. PEER Report 2010/05, November 2010. Prepared by the TBI Guidelines Working Group. Berkeley, California: Pacific Earthquake Engineering Research Center, University of California.

Executive Summary

These *Guidelines for Performance-Based Seismic Design of Tall Buildings* present a recommended alternative to the prescriptive procedures for seismic design of buildings contained in standards such as *ASCE 7* and the *International Building Code (IBC)*. They are intended primarily for use by structural engineers and building officials engaged in the seismic design and review of individual tall buildings. Properly executed, the Guidelines are intended to result in buildings that are capable of achieving the seismic performance objectives for Occupancy Category II buildings intended by *ASCE 7*. Alternatively, individual users may adapt and modify these Guidelines to serve as the basis for designs intended to achieve higher seismic performance objectives.

The Guidelines were developed considering the seismic response characteristics of tall buildings, including relatively long fundamental vibration period, significant mass participation and lateral response in higher modes of vibration, and a relatively slender profile. Although the underlying principles are generally applicable, the Guidelines were developed considering seismic hazard typical in the Western United States. Furthermore, the Guidelines are written to apply to structures intended to resist strong earthquake motion through inelastic response of their structural components. Modifications to the Guidelines may be required to make them applicable to other structural types or to regions with different seismic hazard characteristics.

The Guidelines include the seismic design of structural elements normally assigned as part of the seismic-force-resisting system as well as structural elements whose primary function is to support gravity loads. Except for exterior cladding, design of nonstructural components is not specifically included within the Guidelines. Design for nonstructural systems should conform to the applicable requirements of the Building Code or other suitable alternatives that consider the unique response characteristics of tall building structures.

The organization of the Guidelines is as follows. The first three chapters introduce the scope, target performance objectives, and intended proper use of the procedures contained in the Guidelines. Chapter 4 describes documentation that normally should accompany a design conducted according to the Guidelines. Chapter 5 describes seismic input to be considered for the building design. Chapters 6 through 8 present detailed guidance for preliminary design, design for serviceability, and design for maximum considered earthquake effects. Chapters 9 and 10 outline recommended procedures for presentation of design results and project review, including use of a seismic structural peer review panel.

Acknowledgments

The Tall Buildings Initiative was organized by the Pacific Earthquake Engineering Research Center with funding or in-kind support from the California Emergency Management Agency, the California Geologic Survey, the California Seismic Safety Commission, the Charles Pankow Foundation, the City of Los Angeles, the City of San Francisco, the Federal Emergency Management Agency, the Los Angeles Tall Buildings Structural Design Council, the National Science Foundation, the Southern California Earthquake Center, the Structural Engineers Association of California, and the United States Geologic Survey.

The Charles Pankow Foundation provided funding for the development of the *Guidelines for Performance-Based Seismic Design of Tall Buildings*. Dr. Robert Tener, Executive Director of the Charles Pankow Foundation, provided valuable guidance on the development and execution of this project. A working group comprising the authors of this report developed the Guidelines through a series of meetings and review cycles in which Guidelines drafts were reviewed and revised. The Guidelines were presented and discussed in the 2009 and 2010 Conferences of the Los Angeles Tall Buildings Structural Design Council and the combined 2010 annual meeting of the George E. Brown Network for Earthquake Engineering Simulation and the Pacific Earthquake Engineering Research Center.

The Guidelines were further tested through a series of tall building designs, under funding from the California Emergency Management Agency, the California Seismic Safety Commission, the Charles Pankow Foundation, and the City of Los Angeles. Practicing engineers at Magnusson Klemencic Associates (Seattle), Englekirk Partners Consulting Structural Engineers, Inc. (Los Angeles), and Simpson Gumpertz & Heger (San Francisco) executed the designs. Professors John Wallace (University of California, Los Angeles), Tony Yang (University of British Columbia), Farzin Zareian (University of California, Irvine) oversaw analyses of the completed designs. Norm Abrahamson (Pacific Gas & Electric Co, San Francisco), Nick Gregor (Pacific Engineering and Analysis, El Cerrito, CA), Marshal Lew (MACTEC Engineering and Consulting, Inc., Los Angeles), and Paul Somerville (URS Corporation, Pasadena) conducted seismic hazard analyses and developed ground motions for designs and simulation studies. Constructive comments provided by Richard McCarthy, Ali Sadre, and Fred Turner (California Seismic Safety Commission) are gratefully acknowledged.

Glossary

Action – A force, moment, strain, displacement, or other deformation resulting from the application of design load combinations.

Deformation-controlled action – An action for which reliable inelastic deformation capacity is achievable without critical strength decay.

Force-controlled action – An action for which inelastic deformation capacity cannot be assured.

Capacity Design – A design approach wherein the structure is configured to concentrate yielding and inelastic behavior in specific locations where elements are detailed to reliably exhibit such behavior, and which, through their ductile behavior, limit the demands on other portions of the structure that are designed with sufficient strength to remain essentially elastic during earthquake response.

Capping Strength – The peak strength attainable by a structural component under monotonic loading.

Expected Strength – The probable peak strength of a structural element considering inherent variability in material strength and strain hardening.

Hazard Curve – A plot of the mean annual frequency of exceedance of a ground motion intensity parameter as a function of the ground motion intensity parameter.

Hazard Level – A probability of exceedance within a defined time period (or return period) at which ground shaking intensity is quantified.

Lower-bound Strength – The probable minimum strength that a structural element might develop considering potential variability in material strength and workmanship.

Maximum Considered Earthquake Shaking – The level of shaking specified by the ASCE 7 standard as a basis for derivation of design ground motions.

Monotonic Loading – Loading of a structural component in which the displacement increases monotonically without unloading or reloading.

Peak Strength – The maximum resistance an element will develop under a specific loading protocol.

Return Period – The average time span between shaking intensity that is equal to or greater than a specified value, also known as the recurrence interval; the annual frequency of exceeding a given intensity is equal to the reciprocal of the return period for that intensity.

Service Level Earthquake Shaking – Ground shaking represented by an elastic 2.5%-damped acceleration response spectrum that has a return period of 43 years, approximately equivalent to a 50% exceedance probability in 30 years.

Site-Response Analysis – Analysis of wave propagation through a soil medium used to assess the effect on spectral shape of local geology.

Uniform Hazard Spectrum – A site-specific acceleration response spectrum constructed such that the ordinate at each period has the same exceedance probability or return period.

Notation

A_g	gross area of concrete section
C_d	deflection amplification factor as defined in ASCE 7
D	dead loads, or related internal moments, forces, or deformations, including effects of self weight and permanently attached equipment and fixtures, as defined in ASCE 7
E	earthquake loads, or related internal moments, forces, or deformations
E_c	modulus of elasticity of concrete
E_s	modulus of elasticity of steel, taken as 29,000 kips per square inch
E_x	earthquake loads, or related internal moments, forces, or deformations, resulting from earthquake shaking applied along the principal axis of building response designated as the x axis
E_y	earthquake loads, or related internal moments, forces, or deformations, resulting from earthquake shaking applied along an axis that is orthogonal to the x axis
f'_c	specified compressive strength of concrete
f_y	specified yield strength of structural steel or steel reinforcement
F_c	peak (capping) strength of a component under monotonic loading
$F_{n,e}$	nominal strength computed using applicable material standard strength formulations, but using expected material strength rather than nominal or specified strength
F_r	post-peak residual yield strength of a component under monotonic loading
F_y	effective yield strength of a component under monotonic loading
F_u	strength demand from a suite of nonlinear response history analyses used to evaluate the adequacy of a component to resist a force-controlled action
G_s	shear modulus of steel, taken as 11,500 kips per square inch
G_c	shear modulus of concrete
h	interstory height

I_g	moment of inertia of gross concrete section about centroidal axis, neglecting reinforcement
IM	Ground motion intensity measure, including measures such as peak ground acceleration and spectral response acceleration at a particular period
K_e	effective elastic stiffness
K_p	effective post-yield tangent stiffness under monotonic loading
K_{pc}	effective post-peak strength tangent stiffness under monotonic loading
L	live loads, or related internal moments, forces, or deformations, without reduction based on tributary area, as defined in ASCE 7
L_{exp}	that portion of the live load, or related internal moments, forces, or deformations, expected to be present at the time of significant earthquake shaking
M	earthquake magnitude
P	axial force
P_o	nominal axial strength under loading that produces uniform compressive strain on the cross section
R	distance of a site from an earthquake source
R	response modification coefficient as defined in ASCE 7
u_{FM}	ground motion at the base mat or top of foundation of a building
u_g	ground motion in the free field at the ground surface
V	shear force
δ	interstory displacement
$\delta_c (\theta_c)$	deformation (rotation) at which the peak (capping) strength of a component is attained under monotonic loading
$\delta_p (\theta_p)$	plastic deformation (rotation) of a component available under monotonic loading from effective yield (δ_y) to attainment of peak (capping) strength (δ_c)
$\delta_{pc} (\theta_{pc})$	deformation (rotation) at the post-peak (capping) strength of a component available under monotonic loading prior to failure

$\delta_u (\theta_u)$	ultimate deformation (rotation) at which a component loses all strength
$\delta_y (\theta_y)$	component yield deformation (rotation)
ε	number of standard deviations that a spectral response acceleration value lies above (+) or below (-) the median value at a given period
θ	elastic stability coefficient
κ	ratio of post-peak (capping) residual yield strength to initial yield strength of a component under monotonic loading
	mean value of a population of values
ν	Poisson's ratio
σ	standard deviation of a population of values
ϕ	strength reduction factor, as obtained from appropriate material standard
Ω_o	amplification factor to account for overstrength of the seismic-force-resisting system as defined in ASCE 7

Contents

Executive Summary	v
Acknowledgments	vi
Glossary	vii
Notation	ix
Table of Contents	xiii
1 INTRODUCTION	1
1.1 Purpose	1
1.2 Scope	2
1.3 Design Considerations	3
1.4 Design Team Qualifications	4
1.5 Limitations	5
2 DESIGN PERFORMANCE OBJECTIVES	7
2.1 Minimum Performance Objectives	7
2.2 Enhanced Objectives	8
3 DESIGN PROCESS OVERVIEW	9
3.1 Introduction	9
3.2 Determine Design Approach	9
3.3 Establish Performance Objectives	9
3.4 Seismic Input	9
3.5 Conceptual Design	10
3.6 Design Criteria	10
3.7 Preliminary Design	10
3.8 Service Level Evaluation	10
3.9 Maximum Considered Earthquake Evaluation	10
3.10 Final Design	10
3.11 Peer Review	11
4 DESIGN CRITERIA DOCUMENTATION	13
4.1 General	13
4.2 Criteria Content	13
4.2.1 Building Description and Location	14
4.2.2 Codes and References	14
4.2.3 Performance Objectives	15
4.2.4 Gravity-Loading Criteria	15
4.2.5 Seismic Hazards	15
4.2.6 Wind Demands	16
4.2.7 Load Combinations	16
4.2.8 Materials	17
4.2.9 Analysis	17
4.2.10 Acceptance Criteria	18
4.2.11 Test Data to Support New Components, Models, Software	19
4.2.12 Appendices	19
5 SEISMIC INPUT	21
5.1 General	21

5.2	Seismic Hazard Analysis	21
5.2.1	Probabilistic Seismic Hazard Analysis	21
5.2.2	Deterministic Seismic Hazard Analysis.....	23
5.2.3	Site-Response Analysis	25
5.3	Soil-Foundation-Structure Interaction	26
5.3.1	Service Level Analysis	26
5.3.2	Maximum Considered Earthquake Shaking Analysis	27
5.4	Selection and Modification of Accelerograms	27
5.4.1	Introduction	27
5.4.2	Identification of Controlling Sources.....	28
5.4.3	Record Selection.....	29
5.4.4	Modification of Accelerograms to Match Target Spectra	30
6	PRELIMINARY DESIGN	33
6.1	General	33
6.2	System Configuration	33
6.3	Structural Performance Hierarchy	36
6.4	Wind.....	37
6.5	Higher-Mode Effects	37
6.6	Seismic Shear Demands	38
6.7	Building Deformations.....	39
6.8	Setbacks and Offsets.....	39
6.9	Diaphragm Demands.....	39
6.10	Outrigger Elements.....	40
6.11	Non-participating Elements.....	40
6.12	Foundations	41
6.13	Slab-Wall Connections	41
6.14	Slab-Column Connections	41
7	SERVICE LEVEL EVALUATION	43
7.1	General	43
7.2	Service Level Earthquake Shaking.....	43
7.3	Performance Objective	44
7.4	Analysis Method	45
7.4.1	General	45
7.4.2	Response Spectrum Analysis	45
7.4.3	Nonlinear Response History Analysis	46
7.5	Linear Structural Modeling.....	46
7.5.1	General	46
7.5.2	Material Stiffness and Strength.....	47
7.5.3	Torsion	48
7.5.4	Beam-Column Joints.....	48
7.5.5	Floor Diaphragms	48
7.5.6	Foundation-Soil Interface.....	49
7.5.7	Subterranean Levels.....	49
7.5.8	Column Bases.....	49
7.6	Design Parameters and Load Combinations	50
7.6.1	Load Combinations – Response Spectrum Analysis	50
7.6.2	Load Combinations – Nonlinear Response History Analysis.....	50
7.7	Acceptance Criteria	50
7.7.1	Actions from Response Spectrum Analysis	50
7.7.2	Actions from Nonlinear Response History Analysis	51
7.7.3	Displacements	51

8	MAXIMUM CONSIDERED EARTHQUAKE SHAKING EVALUATION	53
8.1	Objective	53
8.2	Design and Evaluation Process	53
8.2.1	Design Considerations	53
8.2.2	Evaluation Criteria	54
8.3	General Analysis Requirements	55
8.3.1	Seismic Input	55
8.3.2	Contributions of Gravity Loads	55
8.3.3	Response Analysis Method	55
8.4	System Modeling	56
8.5	Structural Component Modeling	58
8.5.1	Important Modeling Parameters	58
8.5.2	Methods for Computing Component Properties	60
8.5.3	Options for Component Analytical Models	61
8.5.4	Specific Component Modeling Issues	64
8.6	Acceptance Criteria at the Component Level	69
8.6.1	Force-Controlled Actions	69
8.6.2	Deformation-Controlled Actions	71
8.7	Global Acceptance Criteria	71
8.7.1	Story Drift	71
8.7.2	Acceptable Loss in Story Strength	72
9	PRESENTATION OF RESULTS	73
9.1	General	73
9.2	Design Criteria	73
9.3	Geotechnical/Seismic Ground Motion Report	74
9.4	Preliminary/Conceptual Design	74
9.5	Service Level Evaluation	75
9.6	Maximum Considered Earthquake Evaluation	75
10	PROJECT REVIEW	77
10.1	General	77
10.2	Reviewer Qualifications	78
10.3	Scope	78
10.4	Dispute Resolution	79
10.5	Post-review Revision	80
	References	81

1 INTRODUCTION

1.1 Purpose

Structural and geotechnical engineers and researchers associated with the Pacific Earthquake Engineering Research Center developed these *Guidelines for Performance-Based Seismic Design of Tall Buildings* as a recommended alternative to the prescriptive procedures for seismic design of buildings contained in the *ASCE 7* and other standards incorporated by reference into the *International Building Code (IBC)*. These Guidelines may be used as:

a basis for the seismic design of individual tall buildings under the Building Code alternative (non-prescriptive) design provisions; or

a basis for development and adoption of future Building Code provisions governing the design of tall buildings.

Properly executed, the Guidelines are intended to result in buildings that are capable of achieving the seismic performance objectives for Occupancy Category II buildings intended by *ASCE 7*. Alternatively, individual users may adapt and modify these Guidelines to serve as the basis for designs intended to achieve higher seismic performance objectives.

These Guidelines are intended to serve as a reference source for design engineers, building officials, peer reviewers, and developers of building codes and standards.

Commentary: *This document intentionally contains both requirements, which are stated in mandatory language (for example, using “shall”) and recommendations, which use non-mandatory language (for example, using “should”).*

An alternative or non-prescriptive seismic design is one that takes exception to one or more of the requirements of the IBC by invoking Section 104.11 of the Building Code, which reads as follows:

104.11 Alternate materials, design and methods of construction and equipment. *The provisions of this code are not intended to prevent the installation of any material or to prohibit any design or method of construction not specifically prescribed in this code, provided that any such alternative has been approved. An alternative material, design or method of construction shall be approved where the building official finds that the proposed design is satisfactory and complies with the intent of the provisions of this code, and that the material, method or work offered is, for the purpose intended, at least the equivalent of that prescribed in this code in quality, strength, effectiveness, fire resistance, durability, and safety*

Alternative or non-prescriptive seismic designs are also recognized in ASCE 7-05, in Section 12.1.1, paragraph 3 and in ASCE 7-10, Section 1.3 which states:

1.3.1 Strength and stiffness. *Buildings and other structures, and all parts thereof, shall be designed and constructed with adequate strength and stiffness to provide structural*

stability, protect nonstructural components and systems from unacceptable damage and meet the serviceability requirements of Section 1.3.2.

Acceptable strength shall be demonstrated using one or more of the following procedures:

- a. the Strength Procedures of Section 1.3.1.1*
- b. the Allowable Stress Procedures of Section 1.3.1.2; or*
- c. subject to the approval of the authority having jurisdiction for individual projects, the Performance-based Procedures of Section 1.3.1.3.*

1.3.1.3 Performance-based Procedures. *Structural and nonstructural components and their connections shall be demonstrated by analysis or by a combination of analysis and testing to provide a reliability not less than that expected for similar components designed in accordance with the Strength Procedures of Section 1.3.1.1 when subject to the influence of dead, live, environmental and other loads. Consideration shall be given to uncertainties in loading and resistance.*

1.3.1.3.1 Analysis. *Analysis shall employ rational methods based on accepted principles of engineering mechanics and shall consider all significant sources of deformation and resistance. Assumptions of stiffness, strength, damping and other properties of components and connections incorporated in the analysis shall be based on approved test data or referenced Standards.*

The procedures recommended herein are intended to meet the criteria of ASCE 7-10 Section 1.3.1.3 as stated above.

1.2 Scope

The design recommendations contained herein are applicable to the seismic design of structures that generally have the unique seismic response characteristics of tall buildings including:

A fundamental translational period of vibration significantly in excess of 1 second

Significant mass participation and lateral response in higher modes of vibration

A seismic-force-resisting system with a slender aspect ratio such that significant portions of the lateral drift result from axial deformation of the walls and/or columns as compared to shearing deformation of the frames or walls.

The Pacific Earthquake Engineering Research Center developed these Guidelines as an alternative means of compliance with the strength requirements for structural resistance to seismic loads specified in ASCE 7-10 for Risk Category II structures considering the seismic hazard typical in the Western United States. Such structures are intended to resist strong earthquake motion through inelastic response of their structural components. These recommendations may be applicable to the seismic design of structures that do not exhibit substantial inelastic response or that are located in regions with seismicity somewhat different than the Western United States. However, some modification may be appropriate.

Structural design for resistance to loadings other than that associated with earthquakes is beyond the scope of this document. Design of nonstructural components other than exterior cladding for seismic resistance is also not included within the scope of this document. Design for these loadings and systems should conform to the applicable requirements of the Building Code or other suitable alternatives that consider the unique response characteristics of tall building structures.

1.3 Design Considerations

In recent years, structural engineers have designed a number of tall buildings in the Western United States using seismic-force-resisting systems that do not strictly comply with the prescriptive requirements of the Building Code in effect at the time of their design. In some cases, these structures generally complied with the applicable Building Code criteria, except that the height limit specified by the Building Code for the selected seismic-force-resisting system was exceeded, while in other cases, seismic force-resistance was provided by structural systems that were not covered by the Building Code.

The seismic design of these buildings typically was developed using performance-based capacity design procedures in which the engineer proportioned the building for intended nonlinear response and then used nonlinear structural analysis to verify that the structure's performance would be acceptable when subjected to various levels of ground shaking. Building permits for these buildings have generally been issued under Section 104.11 of the IBC. Section 104.11 permits the use of alternative means and methods of design and construction, provided that the building official finds that such design and construction results in a building with performance capability equivalent to that anticipated for buildings that strictly comply with the Building Code criteria. This same approach is adopted by these Guidelines.

Seismic design of tall buildings in accordance with these Guidelines can offer a number of advantages including:

- More reliable attainment of intended seismic performance
- Reduced construction cost
- Accommodation of architectural features that may not otherwise be attainable
- Use of innovative structural systems and materials

Notwithstanding these potential advantages, engineers contemplating building design using these procedures should give due consideration to the following:

Appropriate implementation of these recommendations requires extensive knowledge of ground shaking hazards, structural materials behavior, and nonlinear dynamic structural response and analysis. Engineers who do not have this knowledge should not use these procedures.

Seismic response of structures designed in accordance with these criteria, as well as those designed in conformance to the Building Code, may place

extensive nonlinear cyclic strains on structural elements. In order to reliably withstand such strains, structures must be constructed to exacting quality control standards. These design procedures should not be used for structures that will be constructed without rigorous quality standards.

Acceptance of designs conducted in accordance with these procedures is at the discretion of the building official, as outlined under Section 104.11 of the Building Code. Each building official can and some building officials have declined to accept such procedures. Prior to initiating a design using these recommendations, development teams should ascertain that this approach will be acceptable to the authority having jurisdiction.

The design and permitting process for a building designed in accordance with these Guidelines will generally entail greater effort and take more time than designs that strictly conform to the Building Code prescriptive criteria.

Even in communities where the authority having jurisdiction is willing to accept alternative designs, the development team bears a risk that the authority having jurisdiction will ultimately decide that the design is not acceptable without incorporation of structural features that may make the project undesirable from cost or other perspectives.

In the event that a building designed in accordance with these Guidelines is actually affected by strong earthquake shaking, it is possible that the building will sustain damage. Some stakeholders may deem that this damage exceeds reasonable levels and may attempt to hold the participants in the design and construction process responsible for this perceived poor performance. In this event the engineer of record may be required to demonstrate that he or she has conformed to an appropriate standard of care. It may be more difficult to do this for buildings designed by alternative means than for buildings designed in strict conformance to the Building Code.

Section 1.3 of *ASCE 7-10* requires the use of independent third-party design (peer) review as an inherent part of the design process using alternative means. These Guidelines also recommend such review, as it can help to provide the building official with assurance that a design is acceptable, can suggest approaches that will assist the design team to improve a design's reliability, and can help establish conformance with an appropriate standard of care. It is essential that reviewers possess sufficient knowledge, skill, and experience to serve in this role.

1.4 Design Team Qualifications

Appropriate implementation of the design guidelines presented herein requires sophisticated structural and earthquake engineering expertise including knowledge of:

seismic hazard analysis and selection and scaling of ground motions

nonlinear dynamic behavior of structures and foundation systems and construction of mathematical models capable of reliable prediction of such behavior using appropriate software tools

capacity design principles

detailing of elements to resist cyclic inelastic demands, and assessment of element strength, deformation, and deterioration characteristics under cyclic inelastic loading

Engineers who do not have this expertise and knowledge should not undertake projects utilizing these Guidelines, either as the engineer of record or as a third-party reviewer.

1.5 Limitations

These Guidelines are intended to provide a reliable basis for the seismic design of tall buildings based on the present state of knowledge, laboratory and analytical research, and the engineering judgments of persons with substantial knowledge in the design and seismic behavior of tall buildings. When properly implemented, these Guidelines should permit design of tall buildings that are capable of seismic performance equivalent or superior to that attainable by design in accordance with present prescriptive Building Code provisions. Earthquake engineering is a rapidly developing field and it is likely that knowledge gained in the future will suggest that some recommendations presented herein should be modified. Individual engineers and building officials implementing these Guidelines must exercise their own independent judgments as to the suitability of these recommendations for that purpose. The Pacific Earthquake Engineering Research Center, the University of California, the Charles Pankow Foundation, the California Seismic Safety Commission, other project funding agencies, and the individual contributors to this document and their employers offer no warranty, either expressed or implied, as to the suitability of these Guidelines for application to individual building projects.

2 DESIGN PERFORMANCE OBJECTIVES

2.1 Minimum Performance Objectives

Buildings designed in accordance with these Guidelines are intended to have seismic performance capability equivalent to that intended for similar buildings designed in full conformance with the requirements of the 2009 *International Building Code*, *ASCE 7-05*, and *ASCE 7-10*. As presented in commentary to the FEMA P750 (2009), the Building Code is intended to provide buildings conforming to Occupancy Category II of *ASCE 7-05* (Risk Category II of *ASCE 7-10*) the capability to:

withstand Maximum Considered Earthquake shaking, as defined in *ASCE 7*, with low probability (on the order of 10%) of either total or partial collapse;

withstand Design Earthquake shaking, having an intensity two thirds that of Maximum Considered Earthquake shaking without generation of significant hazards to individual lives through design measures intended to assure that nonstructural components and systems remain anchored and secured to the structure and that building drifts are maintained at levels that will not create undue hazards; and

withstand relatively frequent, more moderate-intensity earthquake shaking with limited damage.

The design recommendations presented in this Guideline seek to satisfy these objectives through requirements to:

proportion and configure structures using capacity design principles;

demonstrate that the structure will be capable of essentially elastic response and limited damage under Service Level Earthquake shaking having a return period of 43 years (50% exceedance probability in 30 years);

demonstrate, with high confidence, that the structure will respond to Maximum Considered Earthquake shaking: without loss of gravity-load-carrying capacity; without inelastic straining of important lateral-force-resisting elements to a level that will severely degrade their strength; and without experiencing excessive permanent lateral drift or development of global structural instability;

detail all elements of the structure for compatibility with the anticipated deformations of the seismic-force-resisting system under Maximum Considered Earthquake shaking; and

anchor and brace all nonstructural components and systems in accordance with the requirements of the Building Code, or alternatively, such that elements essential to protect life safety are anticipated to function and other elements are anticipated to remain in place and not create falling hazards under Design Earthquake shaking.

Commentary: *These Guidelines anticipate that damage in response to Service Level shaking may include minor cracking of concrete and yielding of steel in a limited number of structural elements. Damage occurring in response to Service Level shaking should not compromise the structure's ability to survive Maximum Considered Earthquake shaking, nor should it result in unsafe conditions requiring repair prior to occupancy. Some repair may be needed to restore appearance or protection from water intrusion, fire, or corrosion. Nonstructural damage should be below the threshold that would limit the post-event occupancy of the building.*

2.2 Enhanced Objectives

It may be desirable to design some structures to achieve performance superior to that described in the previous section. Nothing contained within these Guidelines should be interpreted as preventing such design; however it may be necessary to adopt modifications to these recommended Design Criteria to attain enhanced performance. Such modifications could include:

- selection of an alternative, lower probability of exceedance, either for Service Level Shaking or Maximum Considered Earthquake shaking, or both;

- selection of more restrictive acceptance criteria, potentially including lower limiting levels of lateral drift and/or reduced levels of acceptable cyclic straining of ductile elements and larger margins for capacity-protected elements;

- design of nonstructural components and systems to withstand shaking more intense or story drifts larger than that required by the Building Code;

- design to limit residual displacements as a means of ensuring that the structure can be repaired following earthquake ground shaking;

- incorporating the use of damage-tolerant structural elements that are capable of withstanding cyclic inelastic deformation without degradation or permanent distortion; and,

- incorporating the use of response modification devices including isolation systems, energy dissipation systems, and passive and active control systems to limit structural response.

When a design is intended to provide enhanced performance capability, the engineer should prepare a formal written project Design Criteria that explicitly states both the desired performance and the means to be employed to achieve this performance.

3 DESIGN PROCESS OVERVIEW

3.1 Introduction

Chapter 3 presents an overview of the recommended design process and references the location of detailed recommendations.

3.2 Determine Design Approach

Prior to using these recommendations for design, the structural engineer should ascertain that the building official is amenable to performance-based design alternatives and the use of these procedures. In addition, the structural engineer should assure that the development team is aware of and accepts the risks associated with the use of alternative design procedures, that the engineer has the appropriate knowledge and resources, and that construction quality will be adequate to assure that the design is properly executed. Section 1.3 provides additional discussion of these issues.

3.3 Establish Performance Objectives

Section 2.1 describes the target performance capability for buildings designed in accordance with these procedures. The structural engineer should discuss these performance criteria with the development team and the authority having jurisdiction and confirm that these will form an acceptable basis for design. If enhanced performance objectives are desired, the engineer should develop a formal Design Criteria document that modifies the recommendations contained herein as necessary to permit attainment of the enhanced objectives. Section 2.2 provides discussion of some ways this can be accomplished.

3.4 Seismic Input

These procedures require determination of two levels of ground motion: a Service Level shaking motion and a Maximum Considered Earthquake shaking motion. Service Level motion is represented by a 2.5%-damped acceleration response spectrum having a 43-year return period. Maximum Considered Earthquake shaking is represented by a 5%-damped acceleration response spectrum conforming to the requirements of ASCE 7 and a suite of earthquake ground acceleration records that have been appropriately selected and scaled to be compatible with this spectrum. Chapter 5 provides guidance on the representation of ground motion and selection and scaling of records.

Commentary: *As described in Chapter 8, structural analysis for Maximum Considered Earthquake shaking is performed using not more than 2.5% equivalent viscous damping in the structural model. Use of 5%-damped elastic acceleration response spectra to represent Maximum Considered Earthquake shaking is only for convenience to allow comparison with spectra that are generated in compliance with the procedures of ASCE 7.*

3.5 Conceptual Design

In this step the engineer selects the structural systems and materials, their approximate proportions, and the intended primary mechanisms of inelastic behavior. The engineer should use capacity design principles to establish the target inelastic mechanisms. Chapter 6 presents information for development of preliminary designs.

3.6 Design Criteria

The structural engineer of record should develop a formal Design Criteria document that describes: the structural systems and materials of construction; the anticipated mechanisms of inelastic response and behavior; the design performance objectives; the specific design and analysis measures to be conducted to demonstrate acceptable performance capability; and all exceptions to the prescriptive provisions of the Building Code. This Design Criteria document should be submitted to and approved by the authority having jurisdiction and third-party reviewers prior to undertaking substantial design effort. Chapter 4 presents a suggested outline for project-specific Design Criteria.

3.7 Preliminary Design

Dynamic structural analysis is used to confirm that building designs are capable of meeting the intended performance objectives. To perform a meaningful analysis the engineer must develop the building design to a sufficient level of detail to allow determination of the distribution of its stiffness, strength, and mass, as well as the hysteretic properties of elements that will undergo inelastic straining in response to strong ground shaking. Chapter 6 presents information intended to help engineers developing preliminary designs.

3.8 Service Level Evaluation

The Service Level evaluation is intended to demonstrate that the building will be capable of withstanding relatively frequent, moderate-intensity shaking with limited structural damage. Section 2.1 describes the performance expectation, and Chapter 7 presents detailed guidance for performing the Service Level evaluation and confirming acceptable performance capability for Service Level shaking.

3.9 Maximum Considered Earthquake Evaluation

Chapter 8 presents guidance for nonlinear dynamic analysis and acceptance criteria used to demonstrate that buildings have acceptable response characteristics when subjected to Maximum Considered Earthquake shaking.

3.10 Final Design

The final design is documented by the construction documents, including detailed drawings and specifications, supported by extensive calculations and analyses that

result in the generation of large amounts of data. Chapter 9 presents guidance for organizing and summarizing these data in a manner that facilitates review by building departments and third-party reviewers.

3.11 Peer Review

Independent, third-party review should include the design criteria; seismic hazards analysis; selection and scaling of ground motions; proportioning, layout, and detailing of the structure; modeling, analysis, and interpretation of results. Chapter 10 presents recommended review procedures.

4 DESIGN CRITERIA DOCUMENTATION

4.1 General

The structural engineer of record should prepare a formal Design Criteria document that describes the intended structural and nonstructural systems, performance objectives, any intended deviations from prescriptive Building Code criteria, and the specific loading, analysis, design procedures, and acceptance criteria to be employed in the design. The engineer of record should prepare an initial draft of the project Design Criteria as early in the design process as is practical and should update and revise this document as the design is advanced and the details of the building characteristics and performance are better understood. The Design Criteria should contain a summary of the overall design objectives and should be updated at key project milestones. At the conclusion of the design effort, the Design Criteria should provide an accurate summary of the final design and the procedures used to demonstrate its performance capability.

Commentary: *Clear and concise communication of building design intent through a well-prepared “Design Criteria” document is beneficial for all parties involved in building design, review, and implementation. Within the structural engineer’s office, staff members will benefit from consistent and clear direction promoting a well-executed design. Building officials faced with review of the design will gain a clear understanding of how the design is intended to meet or exceed the performance expectations inherent in the Building Code. Peer reviewers, responsible for completing in-depth review of the design, will benefit from a thorough summary of the design objectives, methods of analysis, and acceptance criteria.*

The structural engineer should submit the Design Criteria to the peer reviewers and building official for acceptance well in advance of the submittal of documents for building permits.

Commentary: *It is important to obtain agreement regarding the proposed design approach as early in the process as is practical in order to avoid expending needless effort using an approach that will not receive approval. Once agreement on the design approach is reached, it should be possible to obtain approval simply by demonstrating that the design conforms to the agreed upon criteria. It should be noted, however, that as the details of a design are developed, it may become necessary to revise the previously anticipated design approach, analytic procedures, and/or proposed acceptance criteria. Multiple submissions of the Design Criteria, as it evolves, may be necessary and should be anticipated by all project participants.*

4.2 Criteria Content

The following sections indicate the suggested content for typical project Design Criteria and the types of information that generally should be included.

4.2.1 Building Description and Location

Commentary: *The purpose of this section is to provide a basic understanding of the project scope and a framework that will place the specific Design Criteria presented in other sections into perspective.*

a. General

Provide a brief description of the overall building, including any special or unique features and occupancies. This description should include a characterization of the site, its geographic coordinates, and the underlying site conditions.

b. Description of Seismic and Wind-Force-Resisting Systems

Provide a brief description of the seismic and wind-force-resisting systems. This discussion should include a description of the primary load paths, the anticipated areas of inelastic behavior, and any response modification devices (isolation bearings, passive or active damping, or other) that will be incorporated into the design.

c. Representative Drawings

Provide sufficient floor plans, building sections, and elevations to provide an overview of the building. Drawings should clearly identify the configuration of the primary lateral-force-resisting system.

4.2.2 Codes and References

a. Controlling Codes, Standards, and Other References

Provide a listing of the controlling building codes, including local amendments, and any standards, guidelines, or reference documents upon which the design will be based.

b. Exceptions to Building Code Provisions

Provide a listing of any exceptions or deviations that will be taken from the prescriptive Building Code provisions, together with a brief description of the justification for such exceptions.

Commentary: *Most buildings designed in accordance with these Guidelines will generally conform to the design and construction requirements of the applicable Building Code, with the exception that a limited number of exceptions or alternative criteria will be employed. Because all of the prescriptive requirements of the Building Code are presumed to be important to the building performance, the structural engineer should indicate why non-compliance with any of these criteria will be acceptable for this particular design. Reasons provided could include identification that the requirement is not applicable to the particular building in one or more ways, or that acceptable performance will be assured by other means, such as analysis or testing.*

4.2.3 Performance Objectives

Provide a listing of the expected building performance objectives including the structural and nonstructural components. These objectives should address performance under both Service Level and Maximum Considered Earthquake hazards. A listing of some of the possible components includes:

- Overall Building Performance
- Performance of Structural Elements
 - Walls
 - Columns
 - Beams
 - Braces
 - Floor Slabs
 - Diaphragms
 - Foundations
 - Damping Devices
- Performance of Nonstructural Elements
 - Cladding
 - Partition Systems
 - Elevators
 - Exit Stairs

Commentary: *Tabular summary of the performance objectives for each of the important building components at both Service Level and Maximum Considered Earthquake shaking level is recommended. Include discussion of intended seismic-force-resisting elements and gravity elements.*

4.2.4 Gravity-Loading Criteria

Provide a description of gravity-loading criteria, including allowances for key structural and nonstructural components, and live loading to be applied in different portions of the building. Specify any live load reductions to be employed as well as any special loads including vehicular or special equipment.

4.2.5 Seismic Hazards

Provide a brief summary of the seismic demands to be considered during design including Service Level and Maximum Considered Earthquake shaking as well as any other shaking levels that may be selected. The site characterization and definition of specific seismic demands will likely be more thoroughly addressed in a separate report prepared by a seismic ground motion specialist. The purpose of this section is to briefly summarize important details regarding the seismic hazard that will influence the structural design. This section should, as a minimum, include:

- Site Class per the Building Code.
- Likelihood of seismic hazards other than ground shaking, including liquefaction, land sliding, lateral spreading, or inundation.

Return periods (or annual frequencies of exceedance), and the deterministic or characteristic events that define both the Service Level and Maximum Considered Earthquake shaking.

Elastic acceleration response spectra for the Service Level and Maximum Considered Earthquake shaking.

Acceleration histories that will be used for nonlinear dynamic analysis, including a discussion of the specific earthquakes, their magnitudes, and the recordings used; distances to the instrument and orientation of fault rupture relative to the instrument; and adjustment (scaling/matching) procedures employed. If amplitude scaling is performed, identify the scale factors used. Provide plots that illustrate the extent to which the individual adjusted records and their averages compare with the target design spectra. If spectral matching is used, identify the procedures used to perform such matching.

Include the detailed Site-Specific Seismic Hazard report as an appendix.

Commentary: *It is important that the response spectra and corresponding ground motions to be used in analysis are reviewed and approved by the peer review prior to completing the analytical work.*

4.2.6 Wind Demands

Provide a brief summary of the wind demands that will be considered during design including:

Design wind speed and return period (or annual frequency of exceedance) to be used for strength considerations

Design wind speed and return period (or annual frequency of exceedance) to be used for service level considerations

Site exposure characteristics

Method used to determine wind loadings (analytical or test)

If a wind tunnel test is performed, include the detailed wind tunnel report as an appendix.

Commentary: *Even in regions of very high seismic risk, it is quite possible for wind demands to exceed Service Level shaking demands or, for some elements, even Maximum Considered Earthquake shaking demands. In addition, wind-induced overturning moments may exceed seismic overturning moments when defining the lower-bound strength of the structural system. Wind effects should be evaluated early in the design process.*

4.2.7 Load Combinations

Provide a summary of all design load combinations that will be used and the specific elements to which they will be applied. Refer to Chapters 7 and 8 for further guidance on load combinations.

Commentary: *It is likely that a series of different load combinations will be used for different elements. For example, adequacy of foundations will typically be evaluated using Allowable Stress load combinations. Load and Resistance Factor combinations*

will typically be used for dead, live, wind, and seismic demands on structural steel and reinforced concrete elements. Different load combinations may be used for elements that are intended to exhibit inelastic behavior as opposed to those elements that are intended to remain elastic. Service Level load combinations may be different from those used for Maximum Considered Earthquake response. Also, the treatment of floor live loading may be different in the various load cases. It is important to identify the specific application for each load combination presented.

4.2.8 Materials

Provide a listing of the material properties to be specified on the design drawings, as well as any assumptions regarding material overstrengths or lower-bound strengths to be used in the design evaluations.

Commentary: *Expected material properties will be used in developing mathematical models of the structure, attempting to characterize the expected performance as closely as possible. These same material properties will also likely be used in implementing capacity design concepts and evaluating demand/capacity ratios of elements with benign modes of failure. Lower-bound strengths are likely to be used in demand/capacity assessments of elements with brittle failure modes or modes that can result in catastrophic consequences.*

4.2.9 Analysis

a. Procedures

Provide a summary of each method of analysis (linear static, linear dynamic, nonlinear static, nonlinear response history) that will be used and the anticipated application and purpose of each of these.

b. Analysis and Design Software

Provide a listing of the various analysis and design tools (software) being used, including the specific version of this software.

c. Modeling Procedures and Assumptions

Provide a summary of the modeling procedures and key assumptions to be incorporated in each evaluation including:

- Material properties
- Section property definition
- Joint stiffness assumptions
- Damping assumptions
- Component models and hysteretic behavior
- Boundary conditions

Commentary: *Many designs will incorporate different models and analysis procedures for the Service Level and Maximum Considered Earthquake shaking evaluations. Some designs may also incorporate an evaluation of elements for*

Design Earthquake shaking, as identified in the Building Code. The Design Criteria should separately and completely describe the modeling approach and assumptions used for each analysis employed.

4.2.10 Acceptance Criteria

Provide a summary of all acceptance criteria to be used in demonstrating that the design meets or exceeds the stated performance objectives for both Service Level and Maximum Considered Earthquake shaking. Include details regarding:

- Strength calculations
- Demand/capacity ratios
- Drift limits
- Deformation limits
- Strain limits

For demands obtained from nonlinear dynamic analyses, indicate the statistical quantities from the suite of analysis results that will be used to perform evaluations against the acceptance criteria. Refer to Chapter 8 for further guidance on this subject.

Where strain limits will be used as acceptance criteria, describe specifically how predicted strains will be derived from the analysis.

In addition, show representative details necessary to justify the acceptance criteria. Examples include:

- Concrete confinement details
- Slab-column connection details
- Slab-wall connection details
- Moment frame connection details
- Brace connection details
- Collector details
- Damping device details

Commentary: *Acceptance criteria are the acceptable values of the various response quantities obtained from the analysis. They can include limits on element force demands, element inelastic deformation demands, and global parameters such as drift. Where nonlinear dynamic analysis is performed using suites of ground motions, a suite of demands will be obtained for each of these response quantities. It is not unusual for the coefficient of variation for the values of individual response quantities to range as high as 50%. While it may be appropriate to use mean, or average, demands for response quantities associated with the prediction of failure modes that have relatively benign consequences, it is usually appropriate to use more conservative estimates of demand for behavioral modes that can result in catastrophic consequences. Chapter 5 provides additional discussion of the variability inherent in response quantities obtained from suites of ground motions, while Chapters 7 and 8 recommend acceptance criteria for different types of elements associated with their several behavioral modes.*

4.2.11 Test Data to Support New Components, Models, Software

If the design includes innovative components, materials, modeling techniques, or software, include supporting materials justifying their appropriateness. Where laboratory testing is used as a benchmark for such justification, provide explicit references to publications documenting the tests if they are in the public domain or include copies of test reports in an appendix to the report if the information is not publicly available.

4.2.12 Appendices

Include the following materials in appendices, as appropriate.

- A. Geotechnical Report
- B. Site-Specific Seismic Hazard Report
- C. Wind Tunnel Report
- D. Research Papers as indicated in Section 4.2.11

5 SEISMIC INPUT

5.1 General

Seismic design of tall buildings using these Guidelines requires characterization of two levels of ground shaking: Service Level shaking and Maximum Considered Earthquake shaking. This chapter provides guidance for an overall approach that involves: (1) conducting probabilistic or deterministic seismic hazard analysis to define acceleration response spectra for each of these shaking levels; (2) modifying the spectra as needed for local site effects; and (3) selecting and modifying appropriate accelerograms for response history analysis at the Maximum Considered Earthquake level and Service Level as needed. This chapter also provides guidance for appropriate consideration of soil-foundation-structure interaction effects.

5.2 Seismic Hazard Analysis

Use seismic hazard analysis to determine the appropriate ordinate amplitude of Service Level and Maximum Considered Earthquake shaking level acceleration response spectra. Two types of seismic hazard analyses may be used. Probabilistic seismic hazard analysis generally should be used. At sites that are located within 10 kilometres of one or more known active faults, capable of producing earthquakes with magnitudes in excess of M6, deterministic seismic hazard analysis also should be used for the Maximum Considered Earthquake shaking level. Refer to the requirements of ASCE 7, Chapter 21 to determine whether the results of probabilistic or deterministic seismic hazard analysis should be used to define the Maximum Considered Earthquake acceleration response spectrum.

5.2.1 Probabilistic Seismic Hazard Analysis

Perform probabilistic seismic hazard analysis for Service Level shaking (43-year return period, 50% probability of exceedance in 30 years) and Maximum Considered Earthquake shaking, as defined in ASCE 7 using appropriate contemporary models for the description of regional seismic sources and ground motion prediction equations. Ensure that the recent developments in those topics and the use of the models are properly implemented in the probabilistic seismic hazard analysis code being used. The mechanics of probabilistic seismic hazard analysis are described elsewhere (for example, Stewart et al., 2001; McGuire, 2004) and this section assumes a basic familiarity with the analysis procedures. When conducting probabilistic seismic hazard analysis, account for epistemic (modeling) uncertainties in the input source and ground motion prediction models and in the associated parameter values by including weighted alternatives in the analysis.

Report the following outcomes of probabilistic seismic hazard analysis: (1) mean ground motion hazard curves at key structural periods including 0.2 seconds, 1.0 second, 2 seconds, and the fundamental period of the structure; (2) uniform hazard spectra associated with the Service Level and Maximum Considered Earthquake shaking levels; and (3) percentage contributions to the ground motion hazard at the key structural periods for each hazard level. These contributions are a function of the seismic source,

earthquake magnitude, and source-to-site distance, and are evaluated from deaggregation of the seismic hazard.

Compute uniform hazard spectra over a range of periods extending sufficiently beyond the building fundamental period to encompass shaking intensity at the effective (lengthened) building period during response to Maximum Considered Earthquake shaking.

Commentary: *Uniform hazard spectra have contributions from many seismic sources and, consequently, no one earthquake is likely to produce a response spectrum consistent with the Uniform Hazard Spectra at all oscillator periods. Thus deaggregation information is an important consideration in the selection of acceleration histories, as described further in Section 5.4.*

Probabilistic seismic hazard analysis results for any location in the U.S. can be obtained using the USGS seismic hazard tool (<http://earthquake.usgs.gov/research/hazmaps/index.php>). The USGS site is well maintained and is kept current with respect to source models and ground motion predictive equations. When the Building Code or other seismic regulations call for a “site-specific analysis” of ground motion, a site-specific probabilistic seismic hazard analysis is required in lieu of the USGS website. Site-specific probabilistic seismic hazard analysis can be performed using one of several available commercial codes (for example, FRISKSP, EZ-FRISK, FRISK88M) and the open source code OpenSHA (Field et al., 2003).

Commentary: *The latest revisions to the USGS source models can be found in USGS Open File Report 2008-1128 (Petersen et al., 2008).*

Ground motion prediction equations or attenuation relations provide the median and standard deviation of a ground motion Intensity Measure (IM) conditional on parameters related to source (for example, magnitude, focal mechanism), path (for example, closest distance, position relative to hanging wall), and site (for example, average shear wave velocity in upper 30 m of site, basin depth). For shallow crustal earthquakes in tectonically active regions, the best currently available ground motion predictive equations are those developed in the Next Generation Attenuation (NGA) project (Power et al., 2008). Those models should suffice for estimating ground motions from shallow crustal earthquakes in the Western U.S. Different ground motion predictive equations are needed for ground motions generated by earthquakes occurring on the interplate (interface between Pacific Ocean and North American tectonic plates) and intraplate (Benioff zone) segments of the subduction zones in the Pacific Northwest or Southern Alaska. Table 5.1 summarizes the recommended empirical ground motion predictive equations for both shallow crustal and subduction sources and their major attributes.

Most ground motion prediction equations include a site term that accounts for average site effects. As described further in Section 5.2.3, in many cases this site term is sufficient for practical purposes and no separate modeling of the site response is needed. In other cases, a site-specific analysis of site response is advisable (or required by the Building Code). Guidelines on analysis of that type are presented in Section 5.2.3.

The lack of knowledge regarding which model to use within a particular component of probabilistic seismic hazard analysis is referred to as epistemic uncertainty.

Epistemic uncertainty is ideally incorporated using a logic tree framework with multiple viable values and associated weights of the critical source parameters and multiple ground motion prediction equations. Further details on probabilistic seismic hazard analysis in a logic tree framework are provided in McGuire (2004).

The main drawbacks to the USGS site are that (1) ground motion hazard is computed for a fixed set of source and ground motion predictive equation inputs, thus eliminating the possibility of revising inputs and recomputing the hazard; (2) hazard is computed for a reference site condition of $V_{s30}=760$ m/s; hence site effects are not included in the probabilistic seismic hazard analysis and must be added subsequently in a deterministic manner, which can introduce bias (Goulet and Stewart, 2009); (3) the user cannot perform logic-tree analyses to estimate the effect of epistemic uncertainties on hazard curves or UHS.

The main drawback to site-specific analysis is that it requires knowledge of probabilistic seismic hazard analysis and the underlying models. Inadequate familiarity typically leads to misuse of the software and erroneous results. Therefore, users unfamiliar with probabilistic seismic hazard analysis tools and related models should consider using the USGS website in lieu of site-specific analysis.

5.2.2 Deterministic Seismic Hazard Analysis

Deterministic seismic hazard analysis has the same components as probabilistic seismic hazard analysis (source model, ground motion predictive equations). The difference is that the range of possible results at each stage of the analysis is not considered in deterministic seismic hazard analysis. A single earthquake is considered with a prescribed magnitude and location. A single percentile-level of ground motion is taken from the ground motion predictive equation (for example, 50 percentile, or median, motion). The selections made at the various stages of deterministic seismic hazard analysis are arbitrary and it is often difficult to know *a priori* whether the choices lead to conservative or unconservative estimates of ground motion. Nevertheless, ASCE 7 requires the use of deterministic seismic hazard analysis to provide a deterministic cap on ground motion in regions near major active faults (Leyendecker et al., 2000) to limit ground motion to levels deemed “reasonable” for seismic design.

When deterministic seismic hazard analysis is required per ASCE 7, use the same ground motion predictive equations and weights used in the probabilistic seismic hazard analysis for the controlling fault. Assign the same values to the independent parameters, such as V_{s30} and fault type, as assigned in the probabilistic seismic hazard analysis. Select the maximum magnitude for the controlling fault that is the weighted average of alternative maximum magnitudes listed in the logic tree used in the probabilistic seismic hazard analysis.

Commentary: *More than one fault may produce the largest ground motion response spectrum. For example, a large-magnitude event (for example, $M6.5 - 7.0$) on a nearby fault may produce the largest ordinates of a response spectrum at short and intermediate natural periods, but a great earthquake (for example, $M \sim 8$ or larger) on a fault farther away may produce the largest long-period ordinates.*

Table 5.1 Selected ground motion prediction equations for horizontal response spectra at 5% damping ratio.

Reference	Regression Method ¹	Applicable M Range ²	R range (km)	R type ³	Site Parameters ⁴	Site Terms ⁵	Other Parameters ⁶	Comp ⁷	Period Range ⁸
Active Regions									
Boore and Atkinson (2008) - NGA	2-S/RE	5-8	0-200	R_{jb}^1	V_{s30}	NL	F	gm-rot ⁱ	PGA-10 ⁱ
Campbell and Bozorgnia (2008) - NGA	2-s/RE	4-7.5(n), 8(r), 8.5 (ss)	0-200	R	$V_{s30} \cdot Z_{2.5}^{2.5}$	NL	F, Z_{tot}	gm-rot ⁱ	PGA-10 ⁱ
Abrahamson & Silva (2008) - NGA	RE	5-8.0(r), 8.5(ss)	0-200	R, R_{jb}^1	$V_{s30} \cdot Z_{1.0}^{1.0}$	NL	F, W, Z_{tot} , δ , R'_x , HW	gm-rot ⁱ	PGA-10 ⁱ
Chiou and Youngs (2008) - NGA	RE	4-8(n,r), 8.5 (ss)	0-200	R, R_{jb}^1	$V_{s30} \cdot Z_{1.0}^{1.0}$	NL	F, Z_{tot} , δ , R'_x	gm-rot ⁱ	PGA-10 ⁱ
Idriss (2008) – NGA	1-s	4-8(r), 8.5(ss)	0-200	R	$V_{s30} > 450 \text{m/sec}$		F	gm-rot ⁱ	PGA-10 ⁱ
Subduction Zones									
Atkinson and Boore (2003, 2008)	1-s	5.5-8.3	10-500	Γ_{HYPO} , R	Rock & soil classes	NL	h'	gm	PGA-3
Crouse (1991a, b)	1-s	4-8.2	10-900	Γ_{HYPO} , R	Soil only	na	h	gm	PGA-4
Youngs et. al. (1997)	1-s/RE	5-8.2	10-600	Γ_{HYPO} , R	Rock & soil	na	Z_1 , h ⁱ	gm	PGA 3 or 4
Zhao et. al. (2006)	RE	5-8.3	0-300	Γ_{HYPO} , R	Rock & soil classes	L	h	gm	PGA-5
2-s = two-step regression; 1-s = one-step regression; RE = random effects n = normal fault events; r = reverse fault events; ss strike-slip fault events R = site-source distance; R_{jb} = surface projection distance; Γ_{HYPO} = hypocenter distance V_{s30} = average shear wave velocity in upper 30 m of site; $Z_{2.5}$ = depth to $V_s = 2.5$ km/s; $Z_{1.0}$ = depth to $V_s = 1.0$ km/s NL = site effect is nonlinear; L = site effect is linear; na = not applicable F = style of faulting factor; HW = hanging wall flag; h = focal depth, Z_1 = subduction zone source factor; Z_{tot} = depth to top of rupture; δ = fault dip Component of horizontal motion considered. gm = geometric mean; gm-rot=orientation-independent geometric mean PGA-T means 0 to T sec, where T = 3, 4, 5, or 10 s; PGA-3 or 4 means 0 to 3 s for the rock equations, and 0 to 4 s for soil equations									

A special case of deterministic seismic hazard analysis is to use seismological simulation techniques to generate site ground motions for a prescribed earthquake source function coupled with wave propagation analysis. Chapter 6 of Stewart et al. (2001) describes a number of simulation methods of this type. Advantages of seismological simulation tools are that they are able to produce ground motions for large-magnitude events. The principal disadvantage of these simulation tools is the limited calibration against data and lack of commercial software and understanding of the underlying seismological principles, which has limited their implementation in engineering practice.

5.2.3 Site-Response Analysis

Perform site-response analyses where appropriate and where required by the Building Code. Use either equivalent linear or fully nonlinear methods. Conduct such analyses for several input ground motions and for variations in the soil constitutive models and material properties, including the shear strain-dependent shear moduli and material damping ratios, as well as soil shear strength.

Select records for site-response analysis for a site condition that is generally compatible with the geologic conditions at the bottom of the site profile being simulated. If bedrock is reasonably shallow and its depth is known, the profile should extend into rock, and input motions should be defined for the rock condition. If the site consists of deep soils that cannot be reasonably simulated in their entirety, then the soil profile should extend to a firm soil horizon. In that case, use input motions for weathered bedrock or firm soil conditions. See Section 5.4 for additional considerations for input motion selection.

Commentary: *When performed for a one-dimensional medium, site-response analysis is often referred to as “ground response analysis,” which can serve in some cases as a good approximation of the full three-dimensional site-response problem. Ground response analyses are performed for two principal reasons. The first is to improve predictions of free-field ground surface motions relative to what can be obtained using the site term in a ground motion predictive equation. The second is to estimate the variations with depth of motions through the profile, which can be used to define the seismic demand at the ends of soil springs in soil-structure interaction analyses. However, nonlinear structural dynamic analysis codes presently used for buildings cannot accommodate spatial variations in the input ground motion. This limitation is not considered serious for tall buildings where the spatial variations of long-period motions are expected to be minimal over distances equal to the plan and depth dimensions of the subterranean levels of the building. See Section 5.3 for additional information.*

The commentary to the FEMA 450 (2003) provides guidance on obtaining dynamic soil properties. On-site measurement of V_s should be used in lieu of correlations between V_s and other parameters such as penetration resistance. For most practical situations, the use of modulus reduction and damping curves from correlation relationships should suffice, unless large strain response is expected.

Liquefaction problems are especially challenging in a site-response context. Equivalent linear methods cannot represent the full behavior of liquefied soils because they utilize total stress representations of soil properties that cannot simulate pore pressure generation and its effects on soil properties (for example,

Youd and Carter, 2005). However, approximate equivalent linear moduli and damping values can be assigned to liquefied layers based on an analysis of ground motions at vertical array sites that liquefied (Zeghal and Elgamal, 1994; Elgamal et al., 1996).

5.3 Soil-Foundation-Structure Interaction

It is recommended that the designer consider soil-foundation-structure interaction effects when developing analytical models for seismic evaluation of tall buildings with subterranean levels.

Commentary: *Tall buildings generally have subterranean levels to provide space for parking and other facilities. The most common foundation type is a mat, although pile systems are used as well, particularly for tall buildings without subterranean levels. A schematic illustration of a building with subterranean levels is shown in Figure 5.1a. Spatial variations of ground motion cause motions on foundation slabs (u_{FIM}) to differ from free-field motions (denoted u_g in Figure 5.1a), which is referred to as a kinematic interaction effect.*

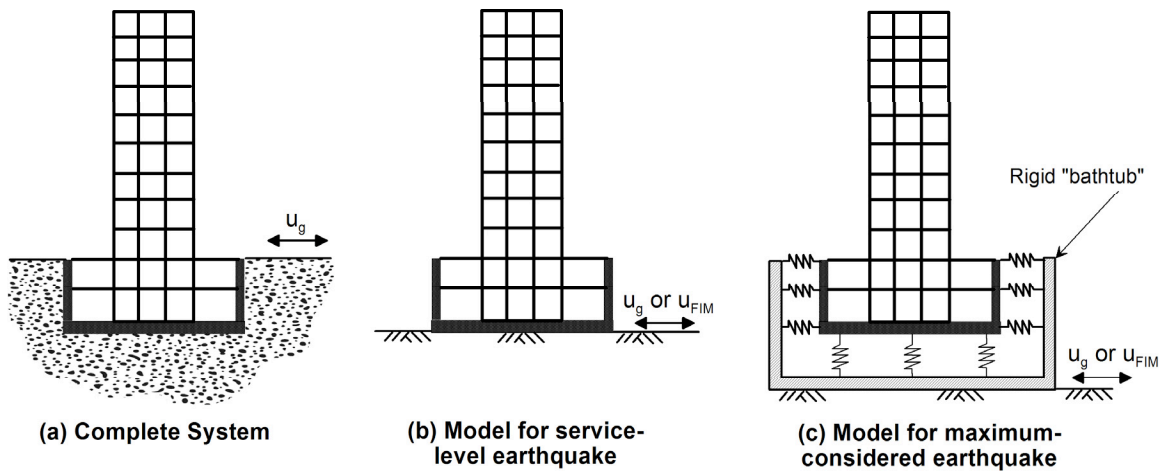

Figure 5.1 Schematic illustration of tall building with subterranean levels (a) and simple models for analysis in which soil-foundation interaction effects are neglected (b) and included in an approximate manner (c). (c) shows only springs but parallel dashpots are generally also used.

5.3.1 Service Level Analysis

Extend analytical models used for Service Level response analysis to the base of the structure, as shown in Figure 5.1b. Include the subterranean levels in the structural model used for dynamic response analysis. Include appropriate element stiffness and capacities for structural members such as walls, columns, and slabs. Soil springs need not be included in the model. Service Level motion should be applied at the base of the structure and can consist either of free-field motion (u_g) or the foundation input motion (u_{FIM}), which is modified for kinematic interaction effects.

5.3.2 Maximum Considered Earthquake Shaking Analysis

Include subterranean levels. If practical, include springs and dashpots representing foundation-soil interaction along basement walls and below the base slab, as shown in Figure 5.1c. Input ground motions to the model via a rigid “bathtub” surrounding the subterranean portions of the structure. Input motion can consist either of free-field motion (u_g) or the foundation input motion (u_{FIM}), which is modified for kinematic interaction effects.

If the above procedure is not practical, use the model shown in Figure 5.1(b). In this case, because the soil springs are not included in the model, the mass of the subterranean levels may also be modified. One option is to include the mass of the core tower below the grade, and exclude the mass of other extended elements in the subterranean levels.

***Commentary:** An approach similar to that described above for buildings with mat foundations should be implemented for pile foundations. Typical engineering practice for this foundation type is to (1) define the free-field ground motion at the level of the pile caps, (2) excite the building with this motion or feed the motion through linear springs/dashpots attached to the pile cap to model the soil-pile interaction, (3) compute the base forces and moments, and (4) input them in a separate soil-pile interaction model to obtain the pile responses.*

Procedures for analysis of kinematic interaction effects are given in FEMA-440 and ASCE 41. Those effects are generally most pronounced at short periods (less than approximately 1 s), and hence are unlikely to significantly affect fundamental mode responses of tall buildings.

The above approach for pile foundations is reasonable for relatively stiff and stable soils, but it may not be acceptable for soils susceptible to failure, where the soil-pile interaction becomes highly nonlinear. In those situations, an iterative solution technique can be implemented in which trial values of equivalent linear springs/dashpots are selected until the base-level displacements computed from the dynamic analysis of the building are compatible with the pile-cap displacements computed from the application of the building base forces and moments to the soil-pile model.

5.4 Selection and Modification of Accelerograms

5.4.1 Introduction

Select and modify accelerograms for structural dynamic analyses using the following steps:

- (1) Identify the types of earthquakes that control the ground motion hazard.
- (2) Select a representative set of at least seven pairs of accelerograms recorded during past earthquakes that are compatible with the controlling events and site conditions.

- (3) Modify those motions in some manner to achieve a match with the target spectrum, either using spectral matching or amplitude scaling.

The following sections provide details on these processes.

5.4.2 Identification of Controlling Sources

Where Maximum Considered Earthquake shaking is controlled by probabilistic seismic hazard analysis, deaggregate the ground motion hazard for the Maximum Considered Earthquake spectral accelerations at the structural natural periods of interest, and use the results as the basis for selecting representative accelerograms for response history analysis. The structural natural periods of interest will include, as a minimum, the first three translational periods of structural response in each of the structure's two principal orthogonal response directions.

Commentary: *In probabilistic seismic hazard analysis results, some of the considered earthquakes contribute much more to the computed hazard than others. Deaggregation of a point on the hazard curve identifies the relative contributions of various seismic sources, earthquake magnitudes, and distances to the computed ground motion. Figure 5.2 shows an example deaggregation for a site in Los Angeles.*

In the figure, the height of the bars at different magnitudes and distances provides information on controlling sources. Deaggregation can also provide information on the degree to which relatively average or extreme ground motions from the ground motion prediction equations contribute to the hazard. This is accomplished through the parameter ε (epsilon), which is defined as:

$$\varepsilon(T) | (M, R) = \frac{\ln(S_a(T)) - \ln_{ln,S_a}(T) | (M, R)}{\sigma_{ln,S_a}(T) | (M, R)} \quad (5.1)$$

where S_a is the level of the spectral response acceleration under consideration (for example, a spectral acceleration of 0.5 g at a natural period T of interest), \ln_{ln,S_a} is the median ground motion for a given magnitude and distance (M and R) from a ground motion prediction equation, and σ_{ln,S_a} is the standard deviation from the ground motion prediction equation. Values of ε for different M, R combinations are shown by the colors of the bars in Figure 5.2. The dark blue colors in the figure indicate that relatively extreme realizations of the ground motion prediction equation are controlling the hazard (that is, ground motions well above the median).

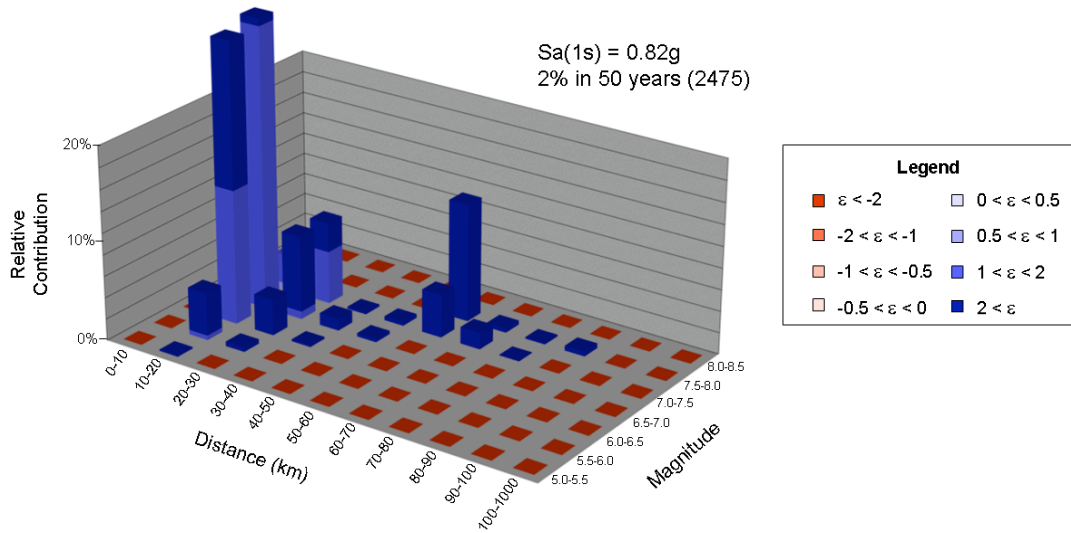

Figure 5.2 Example hazard curve for a site in Los Angeles. The selected IM is 5%-damped 1.0 s pseudo spectral acceleration and the hazard level is 2% probability of exceedance in 50 years. (Goulet et al., 2007).

For very tall buildings, the fundamental period could be 4 s or greater, which can introduce several practical challenges. First, the deaggregation data from the USGS website is available only for periods of 2 s or less. Because deaggregation results are generally strongly period dependent, hazard analysis based on the USGS website should not be used for buildings with fundamental periods significantly beyond 2 s. The NGA ground motion predictive equations are capable of predicting ground motions up to 10 s for active regions. For subduction earthquakes, ground motion predictive equations are not available for periods beyond 3–5 s, which precludes direct hazard analysis and deaggregation at longer periods.

5.4.3 Record Selection

As required by the Building Code, use a minimum of seven accelerogram sets for response history analysis. Each accelerogram set selected must consist of at least two horizontal components, and in rare cases, the vertical component may also be included. Select records that are generally compatible with the earthquake magnitude and site-source distance found from deaggregation. If multiple magnitude-distance combinations contribute significantly to the hazard, then select records from each contributing earthquake as part of the total number of records.

When the hazard is controlled by faults producing moderate to large-magnitude earthquakes at close distances to the site, an appropriate number of the selected ground motion records should include near-fault and directivity effects, such as velocity pulses producing relatively large spectral ordinates at long periods.

Commentary: *Two important considerations in record selection are the number of records to be used for analysis and the attributes of the selected records. If the intent of response history analysis is to reliably characterize both the central value (mean*

or median) of demand parameters as well as the possible dispersion, a large number of record sets (on the order of 20 to 30) would be needed because of significant scatter of structural response to ground motion. However, it has become standard practice to use fewer records because of practical difficulties in running large numbers of nonlinear response history analyses. When these smaller numbers of records are used for analysis, the dispersions in response quantities obtained from the analysis should not be considered to be a reliable estimate of the true dispersion. Either such dispersions should be adapted from other research projects that used much larger sets of input ground motions (for example, Goulet et al. 2007, TBI 2010), or a much larger set of input motions should be used by the designer to estimate the scatter of the structural responses.

Where multiple earthquake events have significant contribution in the deaggregation, it may be necessary to select a larger suite of motions than the seven typically used, to adequately represent the range of response the structure may exhibit in events that could produce Maximum Considered Earthquake shaking.

As described in Section 5.4.2, deaggregation of seismic hazard for long-period spectral accelerations will often indicate large-magnitude earthquakes as a controlling source. Record selection for such events is challenging because few such events have been recorded.

Recent research has suggested that record attributes such as magnitude and distance can produce large dispersion in predictions of certain response quantities such as story drift (for example, Baker and Cornell, 2006). This has motivated the development of an alternative approach for record selection, in which the focus is on spectral shape near the periods of interest in lieu of (or in combination with) magnitude, distance, and similar parameters. Parameter epsilon (defined in Eq. 5.1) has been found to be correlated to spectral shape (Baker and Cornell, 2006), with large epsilon at a given period (T_1) typically associated with rapid decay of spectral ordinates for $T > T_1$.

When using seismological simulation techniques, engineers are cautioned to use motions only from adequately calibrated models that are judged to provide reasonable results. The selected simulation method should incorporate realistic models of fault rupture and wave propagation, including the effects of alluvial basins, which are known to amplify long-period ground motions. Moreover, the simulations should be repeated for multiple reasonable realizations of key source parameters (such as slip distribution, rupture velocity, and rise time).

5.4.4 Modification of Accelerograms to Match Target Spectra

Match records either to the uniform hazard spectrum or conditional mean spectrum. If the conditional mean spectrum approach is used, use a suite of conditional mean spectra, each matched to one of the key periods described in Section 5.4.2. Use of conditional mean spectra for only the fundamental period is not recommended for tall buildings.

Match records to the target spectra either by direct scaling or spectral matching.

Commentary: *There are two principal considerations in the modification of accelerograms to match target ground motion intensity measures. The first is the manner by which the record is modified. The second consideration is the target response spectrum that should be considered in the modification process.*

Two principal procedures are used for ground motion modification: direct scaling and spectral matching. The direct scaling procedure consists of determining a constant scale factor by which the amplitude of an accelerogram is increased or decreased. Because elastic response spectra correspond to linear response of single-degree-of-freedom systems, the same scale factor applies to spectral accelerations at all periods. In contrast, spectral matching adjusts the frequency content of accelerograms until the response spectrum is within user-specified limits of a target response spectrum over a defined period band. Alternative procedures for spectral matching are elaborated in Chapter 7 of Stewart et al. (2001).

Target spectra can be developed using one of the two following options: (1) the design response spectrum developed from the Building Code procedures (which corresponds roughly to the uniform hazard spectrum for the site) or the uniform hazard spectrum from site-specific analysis; or (2) site-specific scenario spectra (one or more) that preserve realistic spectral shapes for controlling earthquakes and that match the design spectral ordinate at periods of interest to the nonlinear response (also known as conditional mean spectra). In the case of Option 1, the target spectrum is a direct result of the ground motion hazard analysis.

For sites within a few kilometers of an active fault that governs the ground motion hazard, target response spectra should be developed for the fault-normal (FN) and fault-parallel (FP) directions.

Baker and Cornell (2005) describe the mathematical procedure for computing the conditional mean spectrum for a given matching period. The matching periods should be selected in consultation with the structural engineer, and will include the elongated fundamental mode period of the structure due to inelastic structural response. Higher-mode periods also should be considered. Note that considering additional periods implies additional conditional mean spectra. When multiple conditional mean spectra are used, multiple suites of each response parameter are obtained from response history analyses. In this case, the envelope value of the response parameter from each suite of analyses should typically be used for design purposes. In general, use of conditional mean spectra for tall buildings will entail considerable additional computational effort. The structural engineer and the ground motion specialist should discuss requirements and expected effort before embarking on the use of conditional mean spectra.

6 PRELIMINARY DESIGN

6.1 General

The growing body of experience resulting from the design of tall buildings using performance-based procedures provides much insight that can be used to guide the preliminary design process. This chapter provides a resource, highlighting important topics shown by experience as critical to consider early in the design process.

***Commentary:** Providing a step-by-step guide for preliminary design of tall buildings conflicts directly with the design innovations these towers many times evoke. Each building and site offers new and unique challenges, requiring careful and specific consideration without preset formulation. The creative design process is generally nonlinear. Therefore, a formal recipe seems out of place. In keeping with this ideal, this section pursues an alternative route, suggesting important design considerations but not providing prescriptive approaches to resolution of the associated issues.*

6.2 System Configuration

To the extent possible, configure the structure to include a simple arrangement of structural elements with clearly defined load paths and regular structural systems. Configurations and geometries that complicate behavior, and add to complexity of analysis and uncertainty, should therefore be avoided to the extent possible include:

- Large changes in building stiffness (Figure 6.1)
- Large changes in building mass (Figure 6.1)
- Repositioning of bracing elements from floor to floor (Figure 6.2)
- Interaction of two or more towers through a common base structure (Figure 6.3)
- Significant column transfers or offsets (Figure 6.4)
- Gravity-induced horizontal shear forces caused by system eccentricities (Figure 6.5)
- Limited connectivity of bracing elements to floor diaphragms (Figure 6.6)

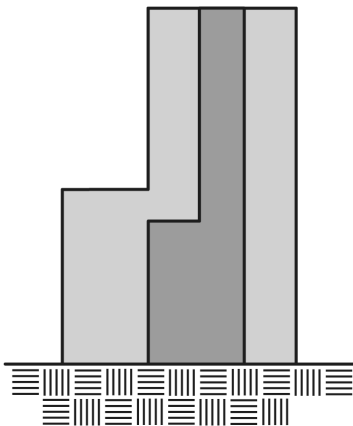

Figure 6.1 Illustration of building with large changes in stiffness and mass.

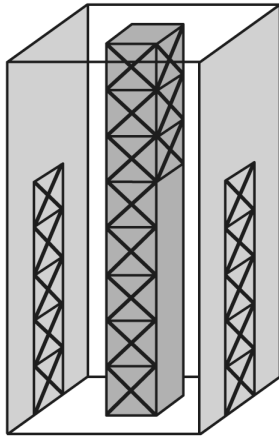

Figure 6.2 Illustration of lateral system with bracing elements repositioned over height of the structure.

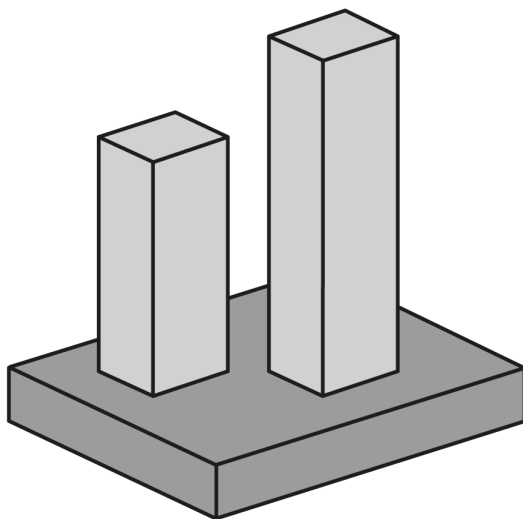

Figure 6.3 Illustration of two towers on a common base.

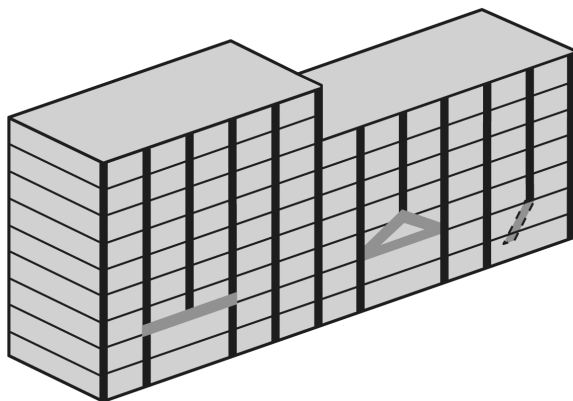

Figure 6.4 Illustration of undesirable column transfer and offset conditions.

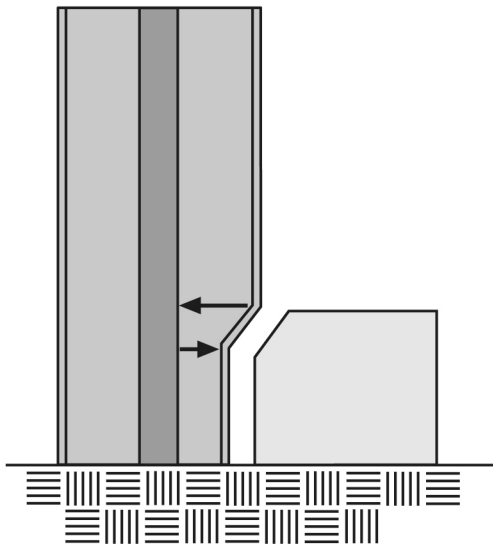

Figure 6.5 Illustration of building geometry resulting in gravity-induced shear forces.

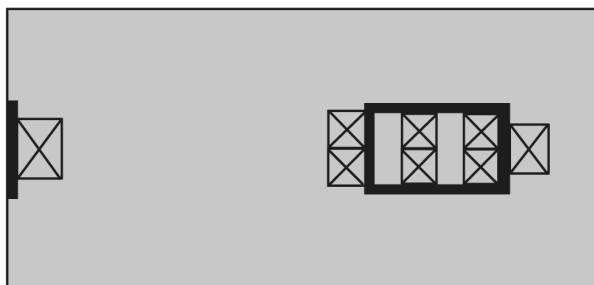

Figure 6.6 Illustration of diaphragms with limited connectivity to vertical elements of the seismic-force-resisting system.

Commentary: Avoidance of the conditions discussed above will allow for a greater degree of confidence in predicting system behavior. The assumptions inherent in any mathematical structural model add to the uncertainty in predicting behavior. Some of these uncertainties can be eliminated through a simple, well-conceived geometry, thus reducing the analytic studies required to test and prove system behavior.

A regular, well-defined system may seem irreconcilable with modern architectural expression. However, a disciplined approach to the architectural design of a tall building, incorporating important structural principles, will generally lead to the most well-behaved and economical structure.

This list of irregularities described is by no means comprehensive, nor can these items be avoided in all buildings. As a structure becomes more complex, the uncertainty in predicting its response escalates, requiring more robust analytic work to adequately test and demonstrate performance.

6.3 Structural Performance Hierarchy

As the structural concept for a tall building is being developed, clearly identify zones or elements where nonlinear response is anticipated. Capacity design concepts are a good starting point when considering desirable system and element actions. While a strict application of capacity design may not be practical or even warranted in the final design, early consideration of these principles will help establish a clear hierarchy to the anticipated building response and will serve to guide the development of the design, which will later be confirmed through nonlinear response history analysis.

A primary aim of the preliminary design should be to select a target yielding mechanism that is practical within the ductility limits of available structural components. For frame or braced frame structures, yielding that is well distributed over the height is preferred to yielding that is concentrated in one or few stories. For core-wall structures, a targeted flexural yielding mechanism that distributes flexural yielding over the lower stories just above a podium may be acceptable.

Another aim of the preliminary design is to target yielding to occur in components that are reliably capable of ductile response. Desirable modes of inelastic response include, but are not necessarily limited to, the following:

- Flexural yielding in reinforced concrete beams, slabs, shear (structural) walls, and conventionally reinforced coupling beams with relatively slender proportions

- Yielding of diagonal reinforcement in diagonally reinforced concrete coupling beams

- Tension yielding in structural steel braces and steel plate shear walls, and tension/compression yielding in buckling-restrained braces

- Post-buckling compression in structural steel braces that are not essential parts of the gravity-load system, and whose buckling does not compromise system behavior

- Shear yielding in structural steel components such as panel zones in moment frames, shear links in eccentric braced frames, and steel coupling beams

- Yielding of outrigger elements, while protecting the axial-load-resisting capacity of gravity-load-carrying outrigger columns

- Yielding in ductile fuses or energy dissipation devices

- Controlled rocking of foundations

Where designs require yielding in components such as gravity-load-carrying columns, for example at the intersection of a frame column with a basement wall or a frame column with roof beams, the design should provide details, possibly beyond the minimum requirements of the Building Code, that ensure adequate behavior at such yielding locations. These yielding locations should be brought to the attention of the

structural peer review panel so that they can be adequately considered early in the review process.

Commentary: *Identification of zones of inelastic response will provide clarity in the overall design approach and the ensuing analytic work. In addition, contemplating the hierarchy of likely response actions to increasing levels of ground motion will provide direction to guide the details of the design to follow.*

Capacity design approaches provide a useful means to configure a structure to produce predictable inelastic behavior. However, the higher-mode response common in tall buildings can lead to inelastic behavior in zones that simplistic approaches to capacity design will be unable to predict. Ultimately, engineers must rely on analytical verification of behavior to detect any additional zones of inelastic behavior other than those suggested by initial capacity design proportioning of the structure.

6.4 Wind

Ensure that the lateral-force-resisting system is adequate for wind resistance considering both strength and serviceability criteria.

Commentary: *While these Guidelines focus primarily on seismic design, it is important to remember that the structural response to wind effects may control the strength and stiffness requirements for tall buildings. Many times occupant comfort related to building accelerations in wind events is the controlling design criterion, directly influencing the required building stiffness to appropriately manage these actions.*

The overall strength of the structural bracing system may be controlled by wind demands. Wind overturning moments and shears in most tall buildings are more closely related to first-mode dynamic response, whereas seismic overturning moments and shears can be heavily influenced by higher dynamic modes of vibration. The net result can be substantially higher wind demands as compared to seismic demands at the base of a tall building, whereas seismic demands may find their peak at the mid-height of the tower.

Wind tunnel studies that model the dynamic actions of a tall building within the context of its surroundings may be important to efficient wind design.

6.5 Higher-Mode Effects

Consider the potential effects of higher-mode response when proportioning the main seismic-force-resisting system.

Commentary: *It is common for higher dynamic modes of vibration to heavily influence tall building response to ground shaking. Traditional engineering practice has focused strictly on the first translational mode when setting strength requirements and lateral force distributions. For tall buildings, the second or even third mode of vibration can be equally, if not more, important to the overall design.*

As illustrated in Figure 6.7, the influence of these higher modes of vibration can result in significantly higher flexural demands, well above the base of a building, as well as shear demands three to four times greater than those anticipated by a typical prescriptive design. Failing to recognize and incorporate these demands into a design can lead to undesirable performance at worst and the need to iterate nonlinear analyses and redesign several times at best.

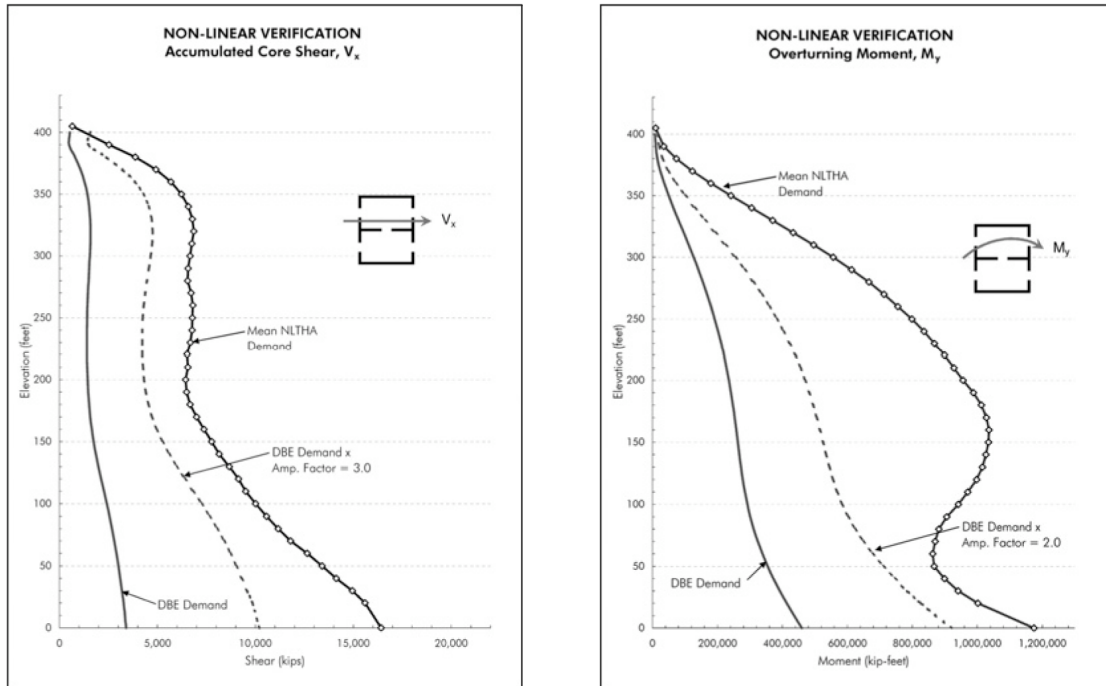

Figure 6.7 Higher-mode effects on shear and flexural demand distributions in a tall core-wall building.

6.6 Seismic Shear Demands

Consider limiting shear stress demands in concrete walls under Service Level seismic forces to the range of $2\sqrt{f'_c}$ to $3\sqrt{f'_c}$ where f'_c is the specified concrete compressive strength in pounds per square inch.

Commentary: As noted in the previous section, the dynamic behavior of high-rise buildings can lead to very high shear demands from higher-mode effects. Experience has shown that limiting Service Level shear stresses in concrete walls to the range of $2\sqrt{f'_c}$ to $3\sqrt{f'_c}$ will generally result in Maximum Considered Earthquake shear demands that fall within maximum shear stress limits.

6.7 Building Deformations

Consider limiting roof displacement predicted by elastic response spectrum analysis under Maximum Considered Earthquake shaking to less than 3% of building height.

Commentary: *Evaluation of overall building deformations at the preliminary design stage offers insight, however limited, into the anticipated behavior considering Maximum Considered Earthquake demands. Maximum building displacements in the range of 2% to 3% of overall height are generally viewed as acceptable for protecting against global instability under Maximum Considered Earthquake shaking. The dynamic characteristics of tall buildings are such that median estimates of total inelastic displacement are predicted well by elastic spectral analysis as long as the structure is not displaced to deformations near those associated with instability.*

Story deformation is a more complex action to evaluate. While traditional design practice has focused purely on translational movements, actions in tall buildings related to shear deformation as opposed to total deformation can be equally important. Griffis (1993) provides greater insight into this topic. Story deformations and their impact on architectural finishes are the key design parameters to consider.

6.8 Setbacks and Offsets

Attempt to avoid setbacks and offsets in the lateral-force-resisting system. Where such geometric configurations are unavoidable due to architectural considerations, consider the provision of supplemental strength and/or detailing for ductile behavior in the areas of these conditions.

Commentary: *Setbacks in overall building geometry or offsets in lateral bracing elements generally lead to a concentration of demands. Care should be taken in these areas during preliminary design to allow for adequate member sizing, anticipating robust detailing requirements in the final design.*

Setbacks in concrete core walls or lateral bracing can result in a high concentration of strain demands through the geometry transition. The potential results include localized yielding of structural elements and the need for robust concrete confinement and/or steel detailing.

Offsets in bracing systems can also result in significant diaphragm demands. Due consideration of the stiffness degradation of these transfer diaphragms as well as the details of structural collector and/or chord elements will be required during later stages of the design process.

6.9 Diaphragm Demands

Pay careful attention to the configuration and strength of diaphragms at transitions in the lateral-force-resisting system.

Commentary: *Diaphragm demands on the floor systems of typical high-rise floors are generally nominal, unless the given floor configuration is long and slender with*

widely spaced bracing elements or features offsets in the primary lateral bracing system.

Diaphragm demands at transitions in building geometry (such as a podium structure) or at the base of a building can be extraordinary and warrant special attention early in the design process. Large shear reversals (back-stay forces) may be predicted by the structural analyses. If these load paths are to be realized, limitations on diaphragm openings and offsets may be required. These requirements can be particularly onerous at the ground level of a building where garage entry ramps, loading docks, retail spaces, and landscaping design often result in geometrically complex floors. Early coordination with the architect is imperative to ensure that adequate load paths will exist in the completed structure. For additional discussion, see Moehle et al. (2010).

6.10 Outrigger Elements

Outrigger systems are often included in high-rise building designs to reduce overturning demands on slender vertical elements of the lateral-force-resisting system (Figure 6.8). It is important to consider the impact of the outriggers on the supporting columns and walls under maximum demand levels. For example, an outrigger supported by a perimeter column may be capable of delivering an axial load much greater than traditionally considered. Evaluating the overstrength characteristics of an outrigger system and the potential impacts on axial and shear demands is critical to ensuring that the overall building system will perform as expected.

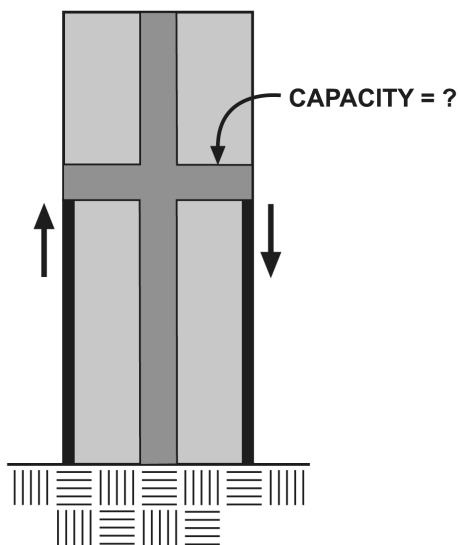

Figure 6.8 Illustration of outriggers used to reduce overturning demands at base of vertical elements of the seismic-force-resisting system.

6.11 Non-participating Elements

Consider the impacts of all building elements on the ultimate behavior and element demands. In addition to providing for deformation compatibility of gravity-load-resisting

elements, consider that axial and shear demands on columns and walls can be significantly influenced by interaction with “gravity framing.”

***Commentary:** Traditional seismic design practice has assigned primary bracing requirements to a few select elements, while the remaining features of the structure have been deemed as “non-participating elements.” This is merely a simplification of the real building actions. Elements intended only to provide gravity resistance can greatly influence the behavior of the main lateral-force-resisting system and also attract substantial earthquake-induced stresses themselves.*

6.12 Foundations

The subject of soil-foundation-structure interaction is complex and often neglected in the design process. Due consideration should be given to the uncertainties related to soil-structure interaction. Traditional practice has input seismic ground motions to structural analysis models at the ground surface in the form of free-field motions. Many times, tall buildings have significant substructures that may play an important role in overall building behavior. A well-considered approach to this topic should be developed during the preliminary design stage. Bounding the response of the structure by varying the foundation support assumptions may be a practical way to address this complex issue. Section 5.3 provides more detailed discussion.

6.13 Slab-Wall Connections

In buildings supported in whole or part by concrete core walls, the integrity of the connection between the floor slabs and core walls is an important consideration. As a tower sways due to wind or earthquake-induced motion, the slab-wall connections may be subjected to significant rotations. The rotations are increased by vertical motions associated with elongation and shortening of the core wall over its height as a result of flexural action. Klemencic et al. (2006) discusses this action and presents details that were found to produce acceptable behavior under Maximum Considered Earthquake demands.

6.14 Slab-Column Connections

Robust detailing of slab-column connections in slab-column systems is important to the integrity of tall concrete buildings. As slab-column connections experience lateral deformations, increased moment and shear demands result. These demands may result in yielding of slab reinforcing steel. More critical is the increased shear demand. Robust details that address/prevent punching shear failure are essential.

7 SERVICE LEVEL EVALUATION

7.1 General

Chapter 7 provides recommended Service Level evaluation criteria, including definition of Service Level Earthquake shaking, performance objectives, general analysis approach, and modeling, design, and acceptance criteria. The recommended general approach is to check Service Level performance using a linear-elastic model, although an option for using a nonlinear dynamic analysis also is provided.

7.2 Service Level Earthquake Shaking

Define the Service Level earthquake shaking as having a minimum return period of 43 years (50% probability of exceedance in 30 years). Represent the Service Level Earthquake shaking in the form of a site-specific 2.5%-damped linear uniform hazard acceleration response spectrum. If nonlinear response history analysis is to be performed as part of the Service Level evaluation (which is an option), select ground motions and modify them to be compatible with the Service Level spectrum in accordance with the recommendations of Chapter 5.

Commentary: *Service Level earthquake shaking is set at a return period of 43 years. Consequently, it can be reasonably expected that a tall building will be subjected to earthquake shaking at or exceeding this shaking level once or more during its service lifetime. These Guidelines anticipate that damage in response to Service Level shaking may include minor cracking of concrete and yielding of steel in a limited number of structural elements. Damage occurring in response to Service Level shaking should not compromise the ability of the structure to survive Maximum Considered Earthquake shaking, nor should it result in unsafe conditions requiring repair prior to occupancy. Some repair may be needed to restore appearance or protection from water intrusion, fire, or corrosion. Nonstructural damage should be below the threshold that would limit the post-event occupancy of the building.*

Considering that response of the building to the Service Level shaking is essentially elastic, the routine approach for checking serviceability will be to use modal response spectrum analysis of a linear model of the structural system. It is permitted, however, to use dynamic analysis of a nonlinear model, in which case it will be necessary to select and scale earthquake ground motions to appropriately match the target response spectrum.

According to the prescriptive provisions of the Building Code, the minimum strength requirements of a building are established using a Design Earthquake whose effects are two thirds of the corresponding Maximum Considered Earthquake effects. These Guidelines do not use the same Design Earthquake, but instead use a two-level design approach, checking serviceability for Service Level effects and stability for Maximum Considered Earthquake effects. Consequently, many engineers will use Service Level earthquake shaking, together with wind demands, to set the structure strength in preliminary design, with later confirmation of adequacy as part of the Maximum Considered Earthquake shaking evaluation. In regions of relatively high

seismicity, including Los Angeles, San Francisco, and Seattle, Service Level shaking will result in required building strength that is of the same order as the strength required using the prescriptive Building Code procedures. However, in some cities with lower seismicity, including Portland, Oregon; Sacramento, California; and Salt Lake City, Utah; Service Level shaking will result in substantially less required strength than would conformance with the Building Code. Engineers designing buildings in locations with this lower seismicity should be aware of this and should understand that Service Level strength requirements may not result in a building of adequate strength. Chapter 8 provides additional discussion of this issue.

A number of studies have attempted to characterize the effective damping in real buildings. These studies range from evaluation of the recorded response to low-amplitude forced vibrations to review and analysis of strong motion recordings. Using data obtained from eight strong motion California earthquakes, Goel and Chopra (1997) found that effective damping for buildings in excess of 35 stories ranged from about 2% to 4% of critical damping. Using data obtained from Japanese earthquakes, Satake et al. (2003) found effective damping in such structures to be in the range of 1% to 2%. Given this information and the impossibility of precisely defining damping for a building that has not yet been constructed, these Guidelines recommend a default value of 2.5% damping for all modes for use in Service Level evaluations.

ASCE 7 (2010) requires that buildings assigned to Risk Categories III and IV have minimum strength respectively at least 125% or 150% of the strength required for buildings in lower Risk Categories. One way to achieve compatibility with this requirement is to increase the amplitude of the Service Level spectrum for such buildings by a factor of 1.25 for Risk Category III and 1.5 for Risk Category IV. Another approach would be to use a somewhat longer return period for the Service Level spectrum.

Regardless of the return period used for the Service Level evaluation, the free-field design spectrum obtained from seismic hazard analysis should not be reduced for embedment or kinematic effects unless specific soil structure interaction analyses are undertaken.

7.3 Performance Objective

For a tall building designed according to these Guidelines, anticipate some limited structural damage when it is subjected to Service Level earthquake shaking. This damage, even if not repaired, should not affect the ability of the structure to survive future Maximum Considered Earthquake shaking. However, repair may be necessary for cosmetic purposes and to avoid compromising long-term integrity for fire resistance, moisture intrusion, and corrosion. If a building is subjected to earthquake shaking more intense than Service Level earthquake shaking, it may no longer be capable of providing serviceable behavior for subsequent shaking at the Service Level unless appropriate repairs are implemented.

Commentary: *Tall buildings may house hundreds to thousands of individuals, either as residences or places of business. Therefore, it is desirable that such buildings remain operable immediately after Service Level shaking. Such performance is*

achievable with minor structural damage that does not affect either immediate or long term performance of the building and therefore does not compromise safety associated with continued building use. Repair, if required, should generally be of a nature and extent that can be conducted while the building remains occupied and in use, though some local disruption of occupancy, around the areas of repair may be necessary during repair activities.

It is important to note that the fitness of a tall building for occupancy depends not only on its structural condition, but also the functionality of key nonstructural components including elevators, stairs, smoke evacuation systems, fire sprinklers and alarms, plumbing, and lighting. These Guidelines do not cover the design of these nonstructural features; rather, these Guidelines assume that as a minimum, these components and systems will be designed and installed in accordance with the requirements of the applicable Building Code and that such design will be adequate to provide the required protection for Service Level shaking. It should be noted that the design of many such components requires determination of a design displacement, which is typically obtained from an elastic analysis for design earthquake shaking.

If unique features of the building's structural design result in response likely to lead to increased susceptibility of these critical nonstructural components to failure, alternative means to protect these critical systems should be considered.

The performance expectation expressed in this Guideline assumes that Service Level shaking affects the building before (rather than after) more severe shaking occurs. Strong earthquake shaking could cause damage to structural and nonstructural components, and might render the building more susceptible to damage under Service Level shaking that occurs at a later date. Repairs may be necessary to return a building to a serviceable condition. If severe damage has occurred under strong earthquake shaking, it may not be possible to repair the structure to a serviceable condition.

7.4 Analysis Method

7.4.1 General

Service Level evaluation shall include a response spectrum analysis in accordance with Section 7.4.2. When demand to capacity ratios determined from such analysis exceed acceptable levels, either the structure is to be redesigned or, alternatively, nonlinear response history analysis, in accordance with Section 7.4.3, may be used to investigate and possibly demonstrate that performance is acceptable.

7.4.2 Response Spectrum Analysis

Linear response spectrum analysis shall be conducted using three-dimensional models satisfying the requirements of Section 7.5 and two horizontal components of motion represented by the linear design spectra defined in Section 7.2. The analysis shall include sufficient modes to include participation of at least 90 percent of the building mass for each principal horizontal direction of response. Modal responses shall be

combined using the Complete Quadratic Combination (CQC) method. The corresponding response parameters, including forces and displacements, termed herein Linear Response Parameters shall be used to evaluate acceptable performance.

Commentary: *The results of Service Level linear response spectrum analysis should not be modified by response modification coefficients, R , or overstrength factors, Ω_0 , nor should the results be scaled to minimum base-shear criteria. Rather, the displacement and strength demands computed from the linear response spectrum analysis should be compared directly with the acceptance criteria of Section 7.7.*

7.4.3 Nonlinear Response History Analysis

Nonlinear response history analysis may be performed to demonstrate acceptable performance when the demand to capacity ratios computed using the linear response parameters from the linear response spectrum analysis exceed the criteria of Section 7.7. When nonlinear response history analysis is performed, modeling shall be in accordance with the recommendations of Chapter 8 and selection and scaling of ground motions shall be in accordance with the recommendations of Chapter 5. Element properties shall be based on expected values of strength. The default values of Table 7.1 may be used for the expected strength of common structural material. Where materials other than these are used, expected strength values shall be based on statistical data from material tests and shall consider potential effects of strain hardening.

Perform analyses using not less than three appropriate ground motion pairs, which shall be selected and modified to be compatible with the Service Level response spectrum. If fewer than seven ground motion pairs are used, the maximum absolute value of each response parameter obtained from the suite of analyses shall be used to determine acceptable performance. Where seven or more pairs of ground motions are used, the mean value of each response parameter shall be used to determine acceptable performance.

7.5 Linear Structural Modeling

7.5.1 General

Conduct linear analyses using a three-dimensional mathematical model of the structure that represents the spatial distribution of mass and stiffness to an extent adequate for calculation of the significant features of the building's linear dynamic lateral response. Models shall include representation of the stiffness of the intended lateral-force-resisting system as well as any vertical-load-bearing elements and nonstructural components that add significant lateral stiffness or that will experience significant stress in response to Service Level shaking.

Commentary: *Three-dimensional mathematical structural models are required for all analyses and evaluations. Given the current state of modeling capabilities and available software systems, there is no reason to estimate the actual three-dimensional behavior of tall buildings by relying on approximate two-dimensional*

models. The accuracy obtained by using three-dimensional models substantially outweighs the advantage of the simplicity offered by two-dimensional models.

Although analytical models used to perform linear response spectrum analysis as part of the prescriptive Building Code procedures typically do not include representation of elements other than those that compose the intended lateral-force-resisting system, in tall buildings the gravity-load-carrying system and some nonstructural components can add significant stiffness. Because the goal of Service Level evaluation is to accurately project the building's probable performance under Service Level shaking, it is important to include such elements in the analytical model and also to verify that their behavior will be acceptable.

7.5.2 Material Stiffness and Strength

Structural models shall incorporate realistic estimates of stiffness considering the anticipated level of excitation and damage. Use expected, as opposed to nominal or specified properties when computing modulus of elasticity. In lieu of detailed justification, values provided in Table 7.2 may be used for estimates of component stiffness.

Table 7.1 Expected material strengths.

Material	Expected Strength
Structural Steel	
Hot-rolled structural shapes and bars	
ASTM A36/A36M	1.5 fy*
ASTM A572/A572M Grade 42 (290)	1.3 fy
ASTM A992/A992M	1.1 fy
All other grades	1.1 fy
Hollow Structural Sections	
ASTM A500, A501, A618 and A847	1.3 fy
Steel Pipe	
ASTM A53/A53M	1.4 fy
Plates	1.1 fy
All other Products	1.1 fy
Reinforcing Steel	1.17 fy
Concrete	1.3 fc'

* fy is used to designate specified yield strength of steel materials in this Guideline. It is equivalent to Fy used in AISC standards.

Table 7.2 Effective component stiffness values.

Component	Flexural Rigidity	Shear Rigidity	Axial Rigidity
Structural steel Beams, Columns and Braces	$E_s I$	$G_s A$	$E_s A$
Composite Concrete Metal Deck Floors	$0.5E_c I_g$	$G_c A_g$	$E_c A_g$
R/C Beams – nonprestressed	$0.5E_c I_g$	$G_c A_g$	$E_c A_g$
R/C Beams – prestressed	$E_c I_g$	$G_c A_g$	$E_c A_g$
R/C Columns	$0.5E_c I_g$	$G_c A_g$	$E_c A_g$
R/C Walls	$0.75E_c I_g$	$G_c A_g$	$E_c A_g$
R/C Slabs and Flat Plates	$0.5E_c I_g$	$G_c A_g$	$E_c A_g$

Notes:

E_c shall be computed per ACI 318, using expected material strength per Table 7.1.

G_c shall be computed as $E_c / (2(1 + \nu))$, where ν shall be taken as 0.2.

7.5.3 Torsion

The mathematical model shall address torsional behavior of the structure. Inherent eccentricities resulting from the distribution of mass and stiffness shall be included. Accidental eccentricities need not be considered for serviceability evaluation.

Commentary: *ASCE 7 requires consideration of accidental eccentricities when determining the forces and displacements used for design. These accidental eccentricities are intended to assure that the structure is torsionally stable and also to account for the real torsional conditions that occur even in nominally symmetric buildings as a result of variation in material strength, tenant build-out, furniture, and storage loads. These Guidelines do not require consideration of accidental torsion because the three-dimensional modal analyses that are required will detect any torsional instability and because in tall buildings, the torsional eccentricity associated with random variability in loading and material properties will tend towards a mean of zero when considered over many stories and floor levels.*

7.5.4 Beam-Column Joints

Modeling of joints in moment-resisting frames shall accurately account for the stiffness of the joint, including the panel zone. In lieu of explicit modeling of beam-column panel zone behavior, center-to-center beam dimensions may be used.

Commentary: *Additional guidance as to appropriate stiffness assumptions for concrete and steel framing may be found in Moehle et al. (2008) and Hamburger et al. (2009), respectively. Additional guidance for concrete frames is provided in Elwood et al. (2007) and Elwood and Eberhard (2009).*

7.5.5 Floor Diaphragms

Floor diaphragms shall be included in the mathematical model using realistic stiffness properties. Regardless of the relative rigidity or flexibility of floor diaphragms, flexibility of diaphragms with significant force transfer (for example podium levels and other setback levels) shall be explicitly included in the mathematical model. Diaphragm chord and drag forces shall be established in a manner consistent with the floor characteristics, geometry, and well-established principles of structural mechanics. Both shear and bending stresses in diaphragms must be considered. At diaphragm discontinuities, such as openings and re-entrant corners, the dissipation or transfer of edge (chord) forces combined with other forces in the diaphragm shall be evaluated.

Commentary: *Explicit modeling of diaphragms at locations where significant force transfer occurs is necessary to properly identify these effects. Common assumptions of perfectly rigid or flexible diaphragms will not in general provide accurate estimates of transfer forces. It is important to recognize that the vertical location of significant force transfer may occur at diaphragm levels adjacent to the level at which frames or walls are discontinued or introduced. For additional discussion, see Moehle et al. (2010).*

7.5.6 Foundation-Soil Interface

Soil-foundation-structure interaction analysis is not required for serviceability evaluation. However, the model shall extend to the top of the mat foundation or pile caps. Refer to Chapter 5 for additional discussion.

Commentary: *Soil-foundation-structure interaction typically has little effect on the response of tall buildings. Its effect is most significant with regard to the demands on basement walls and slabs, which have typically been demonstrated to be robust in moderate level shaking. Detailed soil-structure interaction is therefore not necessary for service level evaluations where simple yet generally conservative assumptions suffice.*

7.5.7 Subterranean Levels

The analytical model of the structure:

- (1) should include the entire building including the subterranean levels (floors, columns, walls, including the basement walls), as shown in Figure 7.1;
- (2) should include appropriate representation of the mass and mass moment of inertia of the subterranean levels;
- (3) may ignore the horizontal effect of soil surrounding the subterranean levels; and
- (4) may assume rigid soil beneath the foundations (that is, no vertical soil springs).

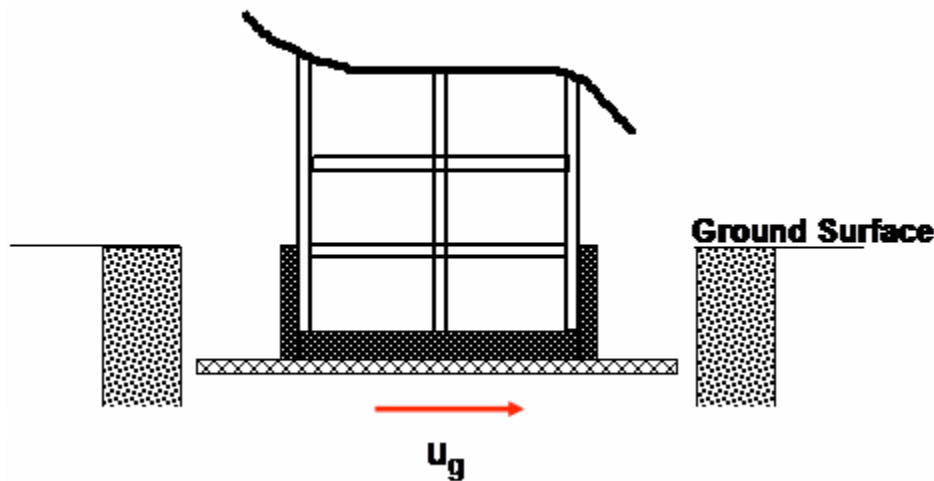

Figure 7.1 Sketch of simplified model for the building and subterranean levels.

7.5.8 Column Bases

Use realistic assumptions to represent the fixity of column bases. A column base may be considered fixed if the column base connection to the foundation is capable of

transferring column forces and deformations to the foundation with negligible joint rotation, considering the flexibility of the foundation itself.

7.6 Design Parameters and Load Combinations

Evaluate roof displacement, story drifts, and member forces (axial, flexure, shear, and torsion) for all members that experience significant force or moment as a result of earthquake response.

7.6.1 Load Combinations – Response Spectrum Analysis

Evaluate the structure for the following load combinations:

$$1.0D + L_{exp} \pm 1.0E_x \pm 0.3E_y \quad (7-1)$$

$$1.0D + L_{exp} \pm 0.3E_x \pm 1.0E_y \quad (7-2)$$

L_{exp} should be taken as 25% of the unreduced live load unless otherwise substantiated.

Commentary: Building Code response modification factors do not apply to serviceability evaluation (that is, R , Ω_0 , ρ , and C_d are all taken as unity).

7.6.2 Load Combinations – Nonlinear Response History Analysis

When nonlinear response history analysis is used for Service Level evaluation, evaluate the structure for the following load combination.

$$1.0D + L_{exp} \pm 1.0E \quad (7-3)$$

Where L_{exp} shall be taken as described in Section 7.6.1.

7.7 Acceptance Criteria

7.7.1 Actions from Response Spectrum Analysis

When response spectrum analysis according to 7.4.2 is used for the Service Level evaluation, demand to capacity ratios shall not exceed 1.5, where demand is computed from Equations 7-1 and 7-2, and capacity is calculated as follows:

- (1) For reinforced concrete elements and their connections, the capacity is defined as the design strength, which is taken as the nominal strength multiplied by the corresponding strength reduction factor ϕ in accordance with ACI 318.
- (2) For structural steel and composite steel and concrete elements and their connections, the capacity is defined as the available strength, which is taken as either the allowable strength (nominal strength divided by the

safety factor) or the design strength (resistance factor multiplied by the nominal strength) in accordance with AISC 341 and AISC 360.

Commentary: *Design strengths are calculated using conventional procedures of ACI 318, AISC 341, and AISC 360, including the use of specified materials strengths and strength reduction (resistance) factors of those codes. It is anticipated that expected strengths will be appreciably higher than the design strengths. Consequently, the demand to capacity ratio of 1.5 based on design strengths can be expected to result in only minor inelastic response, if any.*

Strength reduction (resistance) factors ϕ of ACI 318, AISC 341, and AISC 360 have been defined so as to promote a strength hierarchy in which yielding occurs in deformation-controlled actions before force-controlled actions, but these factors alone may be insufficient to ensure that an appropriate yielding mechanism occurs. It is not uncommon, therefore, to design a structure to satisfy all the Service Level evaluation requirements only to find during the Maximum Considered Earthquake Shaking evaluation that the force-controlled actions are overloaded, requiring time-consuming and expensive redesign. The structural engineer is encouraged to be conservative in the proportioning of force-controlled actions and to employ capacity design concepts in conceptual design to promote desired yielding mechanisms. Ultimately, only the Maximum Considered Earthquake Shaking evaluation (Chapter 8) can provide assurance that appropriate yielding mechanisms occur within deformation and force limits of the structure.

7.7.2 Actions from Nonlinear Response History Analysis

When nonlinear response history analysis according to 7.4.3 is used for the Service Level evaluation, the following shall be satisfied:

- (1) Inelastic deformations shall be restricted to deformation-controlled actions. Force-controlled actions shall not exceed expected strengths. Expected strengths shall be based on laboratory tests. Alternatively, expected strength shall be taken equal to the design strength of ACI 318, AISC 341, or AISC 360, using expected materials strengths instead of specified materials strengths, and using strength reduction (resistance) factors taken equal to 1.0. Refer to Table 7.1 for expected material strengths.
- (2) Deformations shall be less than those that result in damage that requires repair, for reasons of strength deterioration or permanent deformation, as demonstrated by appropriate laboratory testing. Repair, if required, should not require removal and replacement of structural concrete other than cover, or removal or replacement of reinforcing steel or structural steel. In lieu of the use of laboratory test data, it shall be permissible to use the acceptance criteria for Immediate Occupancy performance as contained in ASCE 41.

7.7.3 Displacements

Story drift shall not exceed 0.5% of story height in any story.

Commentary: *The story drift limit of 0.5% for Service Level shaking is intended to provide some protection of nonstructural components and also to assure that permanent lateral displacement of the structure will be negligible. It is important to understand that at story drift of 0.5%, nonstructural damage, particularly for elements such as interior partitions, may not be negligible and considerable cosmetic repair may be required.*

8 MAXIMUM CONSIDERED EARTHQUAKE SHAKING EVALUATION

8.1 Objective

This chapter sets recommended criteria for Maximum Considered Earthquake shaking evaluation. The objective of this evaluation is to provide adequate safety against collapse. This objective is implicitly achieved by using nonlinear response history analysis to evaluate the response of a building to a limited suite of ground motions that represent Maximum Considered Earthquake shaking as defined in Chapter 5. This response evaluation does not provide a quantifiable margin against (or a probability of) collapse, but is intended to demonstrate that, under the selected ground motions, collapse does not occur, and forces and deformations are within acceptable limits.

Commentary: *The seismic design procedures contained in ASCE 7 are intended to assure an acceptably low conditional probability of collapse for structures subjected to Maximum Considered Earthquake shaking. As noted in commentary to the 2009 NEHRP Provisions (FEMA P750, 2009) and to ASCE 7 (2010), for Occupancy (Risk) Category II structures, the target conditional probability of collapse is intended to be 10% or less, with lower acceptable collapse probabilities for structures in higher Occupancy Categories (applicable to some tall buildings).*

The conditional probability of collapse for a structure, at a particular ground motion intensity, is a function not only of the structural strength, deformation capacity, and nonlinear response characteristics, but also of a number of uncertainties including ability to predict the ground motion characteristics and to model and predict the building response given the ground motion. For certain classes of structural systems, the technical capability exists to calculate the probability of collapse as a function of ground motion intensity (ATC 63, 2008; Zareian and Krawinkler, 2007). However, the process of collapse prediction is complex and is based on the assumption that the force-deformation characteristics of all important structural components can be modeled for the full range of deformations leading to collapse. At the time of this writing, insufficient knowledge exists to model such behavior with confidence for all the types of structural components that might be used in tall buildings. Furthermore, the software tools available to engineers do not permit such evaluations within the resources and time constraints available on most design projects. Until such knowledge and software tools are available, the stability evaluation recommended in this chapter is the preferred method for providing adequate safety against collapse.

8.2 Design and Evaluation Process

8.2.1 Design Considerations

As described in Section 6.3 of these Guidelines, the structural concept for a tall building should clearly identify zones or elements where nonlinear response is anticipated. Capacity design concepts should be employed to identify target yielding zones and mechanisms, which subsequently are detailed for ductile response, and to establish minimum strength requirements for zones and actions that are intended to remain

essentially elastic as the building responds to earthquake shaking. See Chapter 6 for discussion of desirable inelastic response modes.

The structural analysis model will be defined so that it is capable of modeling the intended inelastic response, and structural analysis will be used to confirm that: (1) inelastic deformations are indeed concentrated in the intended yielding zones; (2) inelastic behavior is in desirable behavior modes; and (3) excessive force and deformation demands for undesirable behavior modes are avoided. Where overloads are indicated in components or actions not originally intended for inelastic response, either the components or actions should be redesigned for additional strength to avoid inelastic response, or the structural analysis model should be updated to directly model inelastic response in these components or actions.

For behavior modes in which inelastic deformation capacity cannot be assured, it is essential to avoid actions (forces or moments) that exceed the reliable force capacities and to protect, through appropriate proportioning and detailing, against unexpected brittle failure modes

Commentary: *This Guideline is written around the assumptions that (a) the structural system will sustain inelastic response under the Maximum Considered Earthquake shaking and (b) preliminary design of the structural system (Chapter 6) is based on an intended yielding mechanism that is capable of ductile response under Maximum Considered Earthquake shaking. Capacity design concepts should be an integral part of the design process that determines initial proportions, relative strengths, and details of the structural system.*

Tall buildings are complex dynamic systems and in many cases it will not be possible using capacity design alone to identify all zones in which inelastic deformations may occur. Nonlinear dynamic analysis will be used to identify whether inelastic deformations occur only in the intended zones or whether they also occur in other zones under dynamic response. An important goal of the response evaluation process is to identify all regions of potential inelastic behavior, whether or not they have been targeted in preliminary design as zones of desired inelastic behavior. A typical example of “non-targeted zones” of inelastic behavior is flexural yielding in middle or upper stories of shear walls, which often is caused by higher-mode effects. Another similar example is flexural yielding of columns in middle or upper levels of special moment frames, even though columns are made flexurally stronger than beams. If such yielding is observed in the response evaluation, then these “non-targeted zones” have to be detailed appropriately for ductility.

8.2.2 Evaluation Criteria

Section 8.3 describes general analysis requirements. Sections 8.4 and 8.5 present recommendations for structural modeling. Section 8.6 presents criteria for evaluating the adequacy of response at a component level. Section 8.7 presents criteria for evaluation of response adequacy at a global level, including consideration of peak transient and residual drift, and loss of story shear strength.

8.3 General Analysis Requirements

8.3.1 Seismic Input

Analyze the structure for a minimum of seven pairs of orthogonal ground motion components, selected and modified for compatibility with the target Maximum Considered Earthquake shaking spectrum in accordance with the recommendations of Chapter 5.

Apply the pairs of accelerograms along the principal directions of response unless near-fault directionality effects dominate the ground motion, in which case the accelerograms should be applied in the fault-parallel and fault-normal directions.

Derive the effective seismic mass from the full dead loads, including appropriate contributions from partitions and other transient loads that might contribute significantly to structural response.

8.3.2 Contributions of Gravity Loads

The following gravity loads should be applied as initial conditions in the analysis:

$$1.0D + L_{exp} \quad (8-1)$$

where L_{exp} shall be taken as described in Section 7.6.1.

Commentary: *Nonlinear analysis is load path dependent, and the results depend on combined gravity and lateral load effects. The gravity load applied in the analysis should be equal to the expected gravity load. The dead load should include the structure self-weight, architectural finishes (partitions, exterior wall, and floor and ceiling finishes), and an appropriate allowance for mechanical and electrical services and equipment. The live load should be reduced from the nominal, unreduced design live load to reflect: (1) the low probability of the full design live load occurring simultaneously throughout the building and (2) the low probability that the design live load and Maximum Considered Earthquake shaking will occur simultaneously.*

8.3.3 Response Analysis Method

Perform nonlinear response history analysis using a three-dimensional model of the structure including subterranean levels. Soil-foundation-structure interaction effects may be included as described in Chapter 5. Ground motion shall be introduced at the base mat or top of pile caps or through soil springs as described in Chapter 5.

Commentary: *Nonlinear static procedures (pushover analysis) may be useful as a design aid, but should not be relied upon to quantify response characteristics for tall buildings. Depending on the option used, they produce results of unknown reliability, and in general are unable to reproduce phenomena that are a consequence of dynamic response and inelastic force redistribution, such as shear force amplification in shear walls caused by flexural plastic hinging at the base of the wall. There is much intrinsic value to a nonlinear static analysis (for instance it permits graphical representation and visualization of progression of inelastic behavior under simplified*

loading) and can assist in identifying the primary modes of inelastic behavior under first-mode response. However, in many practical cases, inelastic static analysis is not capable of identifying the effects of variations in the frequency content of the ground motions and of variations in higher-mode effects.

8.4 System Modeling

The three-dimensional model of the structural system should represent all components and force and deformation characteristics that significantly affect the seismic demands at the Maximum Considered Earthquake response level.

Commentary: *An implication of this recommendation is that components and force or deformation characteristics that do not significantly affect important demands can be ignored. This might apply to components of the foundation system, its interface with the soil, or to the superstructure. Chapter 5 provides additional guidance on modeling of the soil-foundation-structure system.*

The decision about which components and behaviors to include in the structural model requires engineering knowledge and judgment. For instance, if adequate safeguards are taken against excessive shear deformations and shear failure in reinforced concrete components (walls, beams, and columns) through the use of appropriate capacity design concepts, then simulation of shear deformations might not be warranted. But such decisions will require a careful review of analysis results to verify that the analysis assumptions made are indeed justified, and might require post-analysis strengthening or a re-analysis if the assumptions made are shown to be incorrect.

Evaluate force and deformation demands for all components and elements that form an essential part of the lateral and gravity-load path, and whose failure might affect the stability of the structure during and after Maximum Considered Earthquake shaking. Explicitly incorporate in the analysis model components and elements of the gravity-load-resisting system that contribute significantly to lateral strength and stiffness. In order to assure adequate performance of elements that are not explicitly modeled, perform a deflection compatibility check for all components, elements, and connections not included in the analysis model, considering the maximum story drifts predicted by the analysis. Deflection compatibility checks shall consider both local deformations and the accumulated effects of forces that result from those deformations occurring over the height of the structure.

Commentary: *In design of buildings according to the prescriptive provisions of the Building Code, where the intent is to ensure that the seismic-force-resisting system is fully capable of resisting the design seismic loads, the general analysis approach is to include only the seismic-force-resisting system in the structural analysis model. In this Guideline, the intent is to obtain a best estimate of the behavior of the structural system under the Maximum Considered Earthquake shaking. Therefore, all components of the structural system that significantly affect dynamic response should be included in the analysis model.*

In low or moderate rise buildings, it is often sufficient to check that the gravity framing system is stable under the imposed lateral deformations on a story by story basis. In

tall buildings, the imposed lateral deformations can result in overturning actions that accumulate over the building height. These effects should be considered as a routine part of the design evaluation.

Significant hysteretic energy dissipation shall be modeled directly by inelastic elements of the structural analysis model. A small amount of equivalent viscous or combined mass and stiffness proportional damping also may be included. The effective additional modal or viscous damping should not exceed 2.5% of critical for the primary modes of response.

Commentary: *Damping effects of structural members, foundation-soil interaction, and nonstructural components that are not otherwise modeled in the analysis can be incorporated through equivalent viscous damping. The amount of viscous damping should be adjusted based on specific features of the building design and may be represented by either modal damping, explicit viscous damping elements, or a combination of stiffness and mass proportional damping (for example, Rayleigh damping). Chapter 2 of ATC 72 (2010) provides a discussion and recommendations for modeling viscous damping in analytical models of tall building structures.*

The analysis model should be capable of representing the flexibility of the floor diaphragms as necessary to realistically simulate distribution of inertial forces to the various vertical elements as well as transfer forces acting between vertical elements of the seismic-force-resisting system. Of particular importance may be transfer forces around the podium level and other levels where significant discontinuities exist in vertical elements of the seismic-force-resisting system.

Commentary: *Common practice is to model reinforced concrete and concrete on metal deck diaphragms as rigid elements that distribute lateral forces among vertical elements of the seismic-force-resisting system. This approach may result in unrealistically large transfer forces at levels having significant discontinuities in vertical elements of the seismic-force-resisting system. Such levels include the podium, where shear forces from the superstructure are transferred through the podium diaphragms to basement walls, and other setback levels. See additional discussion in Chapter 6. More realistic estimates of the transfer forces at such discontinuities can be obtained by modeling diaphragm flexibility at the level of the discontinuity and perhaps for a few levels below the discontinuity level. Some stiffness reduction to account for diaphragm cracking also may be appropriate. See Moehle et al. (2010).*

At podium levels it is particularly important to model the interaction among stiff vertical elements, the diaphragms, and the basement walls. The so-called “backstay effect” can result in very large transfer forces and may produce a drastic change in shear force and overturning moment below the podium-level diaphragm. The backstay effect will depend strongly on the in-plane stiffness and strength of the diaphragm and its supporting elements. Realizing that these stiffness values depend on the extent of cracking, and that such extent is difficult to accurately calculate, it might be necessary to make bounding assumptions on stiffness properties in order to bracket the forces for which the various components of the podium structure have to be designed.

Represent P-Delta effects in the analytical model, whether or not elastic concepts indicate that such effects are important.

Commentary: *The widely used elastic stability coefficient ($\theta = P\delta/Vh$) is often an insufficient indicator of the importance of P-Delta effects in the inelastic range. P-Delta effects may become an overriding consideration when strength deterioration sets in and the tangent stiffness of the story shear force – story drift relationship approaches zero or becomes negative. When this happens, the story drift ratchets, that is, it increases in one direction without the benefit of a full reversal that otherwise would straighten out the story. For this reason, and many others, realistic modeling of component deterioration and post-yield stiffness are critical aspects of modeling. The potential for dynamic instability is relatively high in flexible moment frame structures and in braced frames and shear wall structures in which one or several of the lower stories deform in a shear mode and the tributary gravity loads are large so that P-Delta effects will lead to a significant amplification of story drift demands. Chapter 2 of ATC 72 (2010) provides detailed information on P-Delta effects and why and when it becomes an important consideration in the inelastic response of structures.*

8.5 Structural Component Modeling

8.5.1 Important Modeling Parameters

Hysteretic models must adequately account for all important phenomena affecting response and demand simulation at response amplitudes corresponding to the Maximum Considered Earthquake shaking. If response simulation is at amplitudes approaching collapse, the hysteretic models shall represent: (a) monotonic response beyond the point at which maximum strength is attained; (b) hysteretic properties characterizing component behavior without the effect of cyclic deterioration; and (c) cyclic deterioration characteristics.

Commentary: *Hysteretic models based solely on monotonic or cyclic envelopes without stiffness and strength deterioration will often be inadequate to accurately simulate demands at response levels approaching collapse. There are many alternatives for describing hysteretic properties in a manner that better models behavior near collapse. This Guideline presents one of the alternatives discussed in detail in Chapter 2 of ATC 72 (2010). Additional alternatives are also presented in that reference.*

Monotonic response may be characterized by a multi-linear diagram of the type shown in Figure 8.1 and referred to herein as the monotonic backbone curve. It is described by the parameters shown in Figure 8.1 and represents the theoretical component force-deformation behavior if the component is pushed in one direction, without cycling, to failure.

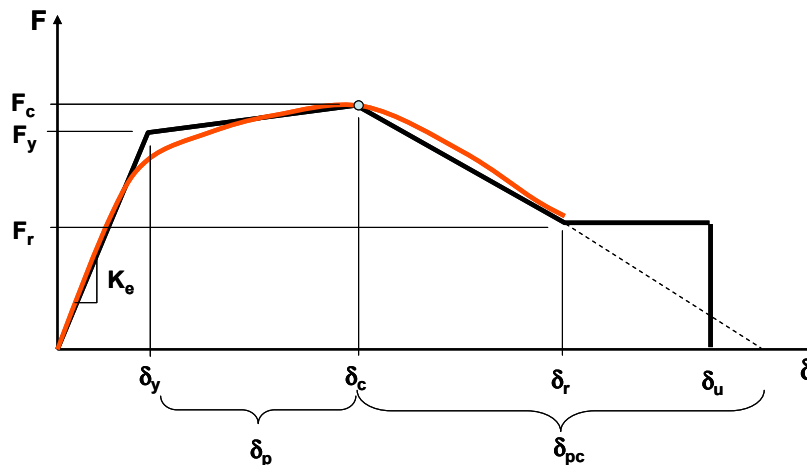

Figure 8.1 Monotonic backbone curve parameters.

Key parameters for this monotonic backbone curve are:

- Effective yield strength and deformation (F_y and δ_y)*
- Effective elastic stiffness, $K_e = F_y / \delta_y$*
- Strength cap and associated deformation for monotonic loading (F_c and δ_c)*
- Pre-capping plastic deformation for monotonic loading, δ_p*
- Effective post-yield tangent stiffness, $K_p = (F_c - F_y) / \delta_p$*
- Post-capping deformation range, δ_{pc}*
- Effective post-capping tangent stiffness, $K_{pc} = F_c / \delta_{pc}$*
- Residual strength, $F_r = \kappa F_y$*
- Ultimate deformation, δ_u*

Hysteretic modeling can follow preselected rules, such as bilinear, peak-oriented, or pinched hysteresis. Cyclic deterioration can be described by a cyclic deterioration parameter, such as the energy-based parameter discussed in Chapter 2 of ATC 72 (2010).

One of the effects of cyclic deterioration is that the point of maximum strength moves closer to the origin, that is, both the peak strength and the deformation at peak strength become smaller with successive cycles. The shift in peak strength and corresponding deformation depends on the loading history.

There are important differences between monotonic backbone curves (for example, Figure 8.1) and cyclic envelope curves obtained from cyclic laboratory testing (for example, Figure 8.2). Compared with the monotonic envelope, the envelope from a typical cyclic test will show smaller deformation capacity and more rapid post-peak strength degradation.

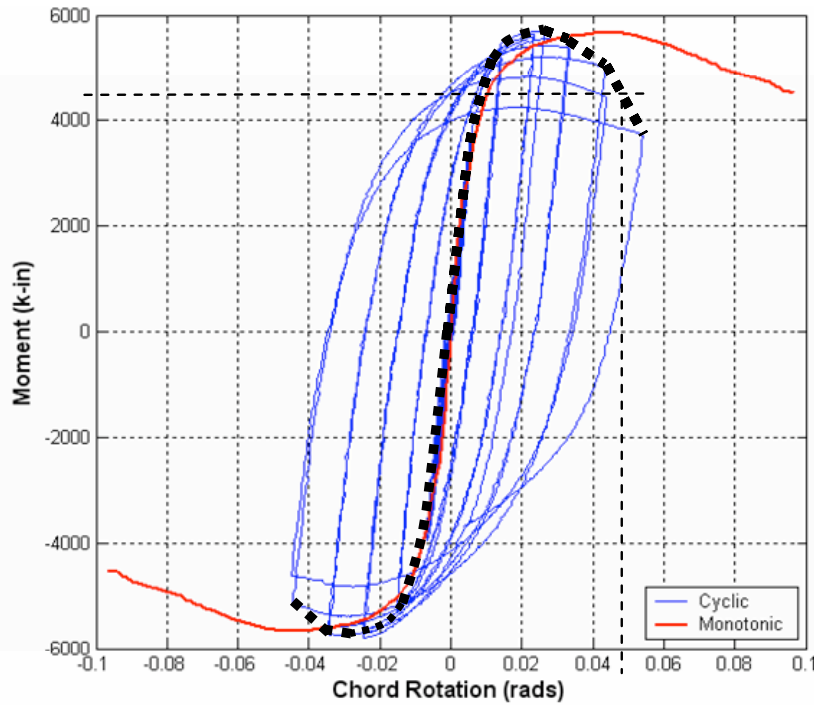

Figure 8.2 Typical monotonic backbone curve and cyclic envelope curve.

8.5.2 Methods for Computing Component Properties

The component monotonic backbone curve and cyclic deterioration characteristics may be obtained from a combination of appropriate analytical approaches and experimental observations. Table 8.1 lists sources of deterioration that should be considered unless precluded by detailing.

Table 8.1 Sources of hysteretic deterioration.

Structural Steel	Reinforced Concrete or Masonry
Compressive buckling of members	Tensile cracking, crushing, and spalling
Local buckling of flanges or webs	Rebar buckling and fracture
Lateral torsional buckling of members	Bond slip
Ductile tearing of base metal	Loss of reinforcement anchorage
Fracture of weldments	Dowel action
Net section fracture of tensile elements	Confinement steel fracture
Bolt slippage	Reduction in aggregate interlock
Block shear failure	Sliding at joints
Bolt yielding and bearing	
Prying action	
Shear buckling	

Strength properties of the component backbone curve should be based on expected material strengths. The values provided in Table 7.1 may be used for expected material strengths.

Acceptable hysteretic modeling can be attained by detailed continuum finite element models, curvature and fiber models, and experiment-based phenomenological models.

Commentary: *Continuum finite element models are usually appropriate provided that cyclic material properties and the aforementioned deterioration/failure modes are adequately simulated. The cost of analysis is prohibitive in most practical applications.*

Curvature and fiber models can be appropriate provided all important deterioration modes can be simulated adequately. Great difficulties are often encountered in simulating deterioration due to local and lateral torsional buckling in steel components, and rebar buckling, bond slip, and shear deformations in reinforced concrete components. Thus, the use of such models often necessitates the specification of artificial limits to simulate these often critical deterioration modes. It is inappropriate to ignore these deterioration modes in curvature and fiber models. In cases of important bi-axial load effects (for example, many columns and shear wall configurations), such models may present the only viable alternative. However, models of this type need to be calibrated with laboratory test results on similar components so that limit states can be approximately related to calculated strains or other calculated parameters.

Phenomenological modeling usually implies the use of concentrated hinge models whose properties are determined from principles of engineering mechanics and are calibrated by means of experimental data. This requires the availability of experimental databases that can be employed to calibrate a phenomenological model for a wide range of parameters. Several extensive databases are available for steel and reinforced concrete beam and column components and have been used to calibrate parameters for the generic deterioration model discussed in Section 8.5.1. Point hinge models are difficult to implement in components subjected to bi-axial bending (many columns and shear wall configurations) and large variations in axial force.

8.5.3 Options for Component Analytical Models

Deformation capacities may be taken equal to the corresponding Collapse Prevention values for primary elements published in ASCE 41 (with Supplement 1) for nonlinear response procedures, or may be based on analytical models validated by experimental evidence. When applicable, the ASCE 41 component force versus deformation curves may be used as modified backbone curves, with the exception that the drop in resistance following the point of peak strength should not be as rapid as indicated in the ASCE 41 curves. Alternatively, the modeling options presented in ATC 72 (2010) may also be employed.

Commentary: *The rapid post-peak drop in resistance indicated in the ASCE 41 curves is not realistic (unless fracture occurs) and is likely to cause numerical instabilities in the analysis process.*

Component models that account neither for post-capping strength deterioration nor for cyclic deterioration should not be used for Maximum Considered Earthquake response evaluation, unless appropriate limitations on the maximum deformation are specified and no credit is given to undefined strength properties beyond this level of deformation. The choice of an appropriate component modeling option and of the basic hysteresis model used to represent the cyclic response of structural components should be justified and become part of the analysis documentation.

Commentary: Chapter 2 of ATC 72 (2010) proposes the following four options for component analytical models.

Option 1 – explicit incorporation of cyclic deterioration in analytical model: This option explicitly incorporates post-capping strength deterioration and cyclic deterioration in the analytical model, by using the monotonic backbone curve as a reference boundary surface that moves “inward” (towards the origin) as a function of the loading history. This is the preferred option.

Option 2 – use of a cyclic envelope curve as a modified backbone curve; cyclic deterioration is not considered explicitly: If the cyclic envelope curve is known (for example, from a cyclic test that follows a generally accepted loading protocol) then it is acceptable to use this envelope curve as the modified backbone curve for analytical modeling and ignore additional cyclic deterioration — provided that no credit is given in the analysis to undefined strength characteristics beyond the bounds established by the cyclic envelope curve, that is, the ultimate deformation δ_u in any analysis should be limited to the maximum deformation recorded in the cyclic test. When using this approximation, one must make sure to include the negative tangent stiffness portion of the cyclic envelope curve as part of the modified backbone curve of the analytical model.

Option 3 – use of factors for modification of backbone curve; cyclic deterioration is not considered explicitly: If only the monotonic backbone curve is known (or predicted) and cyclic deterioration is not incorporated in the analytical model, then the shape of the backbone curve must be modified to account approximately for cyclic deterioration effects. Numerical values of the modification factors might depend on material, configuration, and detailing of the structural component. Until more accurate and component-specific data become available, it is recommended to use the following values for the modified backbone curve:

Strength cap F_c' : 0.9 times the monotonic backbone curve value F_c

Pre-capping plastic deformation δ_p' : 0.7 times the monotonic backbone curve value δ_p

Post-capping deformation range δ_{pc}' : 0.5 times the monotonic backbone curve value δ_{pc}

Residual strength F_r' : 0.7 times the monotonic backbone curve value F_r

Ultimate deformation δ_u' : 1.5 times δ_c of the monotonic backbone curve.

Option 4 – no deterioration in analytical model: If the post-capping (negative tangent stiffness) portion of the modified backbone curve of option 2 or 3 is not incorporated in the analytical model (that is, a non-deteriorating model is employed), then the ultimate deformation of the component should be limited to the deformation associated with 80% of the strength cap on the descending branch of the modified backbone curve as obtained from option 2 or 3. No credit should be given in analysis to undefined strength characteristics beyond this deformation limit.

Figure 8.3 illustrates the four options for a typical experimental cyclic loading history and a peak-oriented hysteresis model. Several equivalent points of equal peak displacement for the four options are identified with symbols. The differences appear to be small, but primarily because the illustrations are for a symmetric and step-wise increasing loading history, which is typical for experimental studies but not for response at the Maximum Considered Earthquake shaking levels. As intended, the greater the simplification, the more the inelastic deformation capacity is being reduced. This is most evident in Figures 8.3(c) and (d), in which the attainment of the estimated δ_u limits the inelastic deformation capacity.

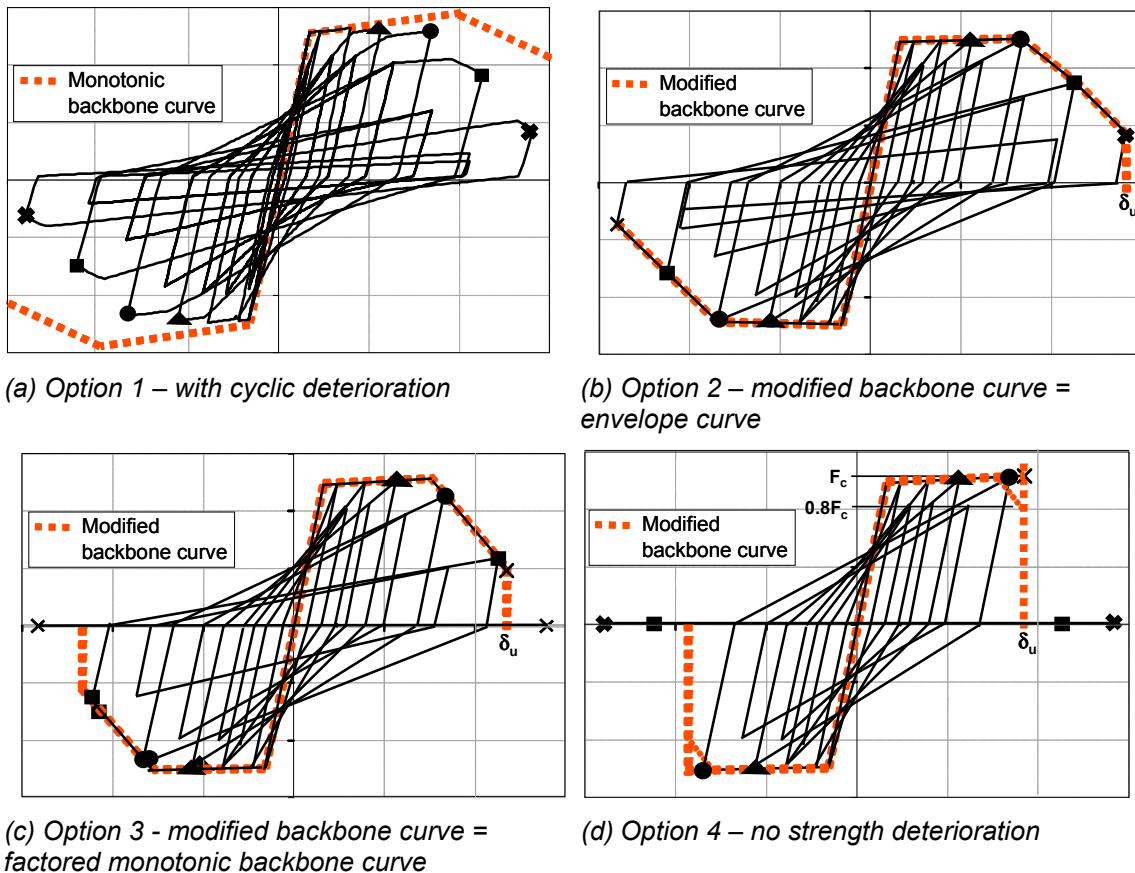

Figure 8.3 Illustration of implementation of the four options for analytical component modeling.

8.5.4 Specific Component Modeling Issues

8.5.4.1 Steel beams and columns in bending

The rotation values provided in Chapter 3 of ATC 72 (2010) should be employed rather than those given in ASCE 41. The deformation values given in ATC 72 (2010) are for the monotonic backbone curve illustrated in Figure 8.1 and shall be modified unless modeling Option 1 is used.

Commentary: *These values are based on the assumption that point hinge models are used to represent inelastic flexural behavior and that one of the four analytical modeling options summarized in the commentary to Section 8.5.3 is utilized. The ATC 72 (2010) values may also be applied to “Fully Restrained Moment Connections.” The values in ASCE 41 Table 5-6 plastic rotation angles for “Beams – Flexure” and “Column – Flexure” should not be used, as those large values are not confirmed through available experimental data.*

One important conclusion drawn from the ATC 72 (2010) data and proposed parameters is that the pre-capping plastic rotation (θ_c) for steel beams is relatively small (on the order of 2%) but the post-capping deformation (θ_{pc}) is large, that is, the decrease in strength after peak strength is slow.

Very few experimental data are available for rotation values for plastic hinging in columns. Until such data become available, low values for θ_c and θ_{pc} should be used, with the maximum assumed values not larger than those given for beams in Chapter 3 of ATC 72 (2010).

8.5.4.2 Steel beam-column joint panel zones

Models shall include the effect of panel zone distortion on overall frame stiffness and on the plastic rotation capacity of fully restrained moment connections. Chapter 3 of ATC 72 (2010) presents acceptable modeling rules for panel zone behavior.

Commentary: *Experimental evidence indicates that deterioration in the shear force – shear distortion response of a joint panel zone is small unless shear buckling occurs. The latter mode is unlikely to occur because of Building Code detailing criteria. Thus, it should be acceptable to neglect deterioration in the modeling of joint panel zones unless there is clear indication that deterioration will occur within the range of deformations expected at maximum considered response levels.*

8.5.4.3 Steel EBF link beams

Plastic deformation values should be based on experimental evidence, particularly if non-standard boundary conditions are employed. Where applicable, the values listed in Table 5-6 of ASCE 41 may be used.

8.5.4.4 Steel coupling beams

The plastic deformation values for eccentric braced frame links may be used for steel coupling beams in walls, provided that the full strength of the coupling beam can be developed through anchorage into the wall. If shear wall anchorage is incapable of

providing fixity, provide additional rotational springs at the ends to account for relative rotation between the coupling beam and the shear wall.

8.5.4.5 Steel axially loaded components

Modeling should consider post-buckling deterioration, ductile tearing due to localized strain reversal during post-buckling cyclic loading, and fracture at connections.

Commentary: *Post-buckling modeling and ductile tearing depends strongly on brace section and slenderness ratio. Recent references on these deterioration and failure modes include Jin and El-Tawil (2003), Uriz (2005), Uriz et al. (2008), Fell et al. (2006), Fell (2008).*

Braces in frame configurations and in outriggers depend strongly on the ability of the connections to transfer pre- and post-buckling forces from the brace to horizontal and vertical chord members. Additional strain may be placed on the connection by relative rotations of the chord members at the brace intersections. It is of paramount importance to consider all conceivable failure modes at the brace connection when assigning strength and deformation parameters to the bracing member.

8.5.4.6 Steel plate shear walls

Modeling shall adequately represent the effective story shear strength and stiffness, including the pinching effect caused by tension field reversal, deterioration due to connection failures, and possibly due to combined bending and axial load effects in the vertical boundary elements. If cyclic strip models are used, a sufficient number of strips must be used to adequately simulate the column bending moments due to force transfer between the shear wall panel and the vertical boundary elements.

Commentary: *At large story drifts the combined bending and axial load capacity of the vertical boundary elements might deteriorate due to shear racking that causes large localized rotations in these boundary elements. P-Delta effects might become a critical issue if the shear wall deforms in a shear racking mode that concentrates inelastic deformations in the lower stories. Information on modeling of steel plate shear walls can be found in AISC (2006) and in the many references listed in that publication.*

8.5.4.7 Reinforced concrete beams and columns in bending

Either the values provided in Chapter 3 of ATC 72 (2010) or those given in ASCE 41 (including Supplement 1) may be used. The ATC 72 (2010) values are based on the assumption that point hinge models are used to represent inelastic flexural behavior and that one of the four analytical modeling options summarized in the commentary to Section 8.5.3 is used. The deformation values given in ATC 72 (2010) are for the monotonic backbone curve illustrated in Figure 8.1 and need to be modified unless modeling Option 1 is used.

Commentary: *The rotation values in Chapter 3 of ATC 72 (2010) are in many cases significantly larger than those listed in ASCE 41. The reasons are (1) the listed plastic rotations are for the monotonic backbone curve and would have to be modified (by a recommended factor of 0.7) for comparison with the ASCE 41 values,*

and (2) the listed values are expected values, whereas the ASCE 41 values represent a lower percentile value (15% or 35% depending on failure mode).

The ATC 72 (2010) values have been derived from a database that contains mostly experimental results from column tests. The regression equations have been extrapolated to an axial load of zero in order to be applicable for beams. This process may not be fully justified because beams may have unequal top and bottom longitudinal reinforcement and no distributed side face reinforcement, and in most cases have contributions from a slab system. Guidance for modeling slab contributions can be found in Moehle et al. (2008).

Elastic stiffness used in the analytical model may follow the guidance of Chapter 3 of ATC 72 (2010) or that in ASCE 41 Supplement 1.

Commentary: *ATC 72 (2010) and ASCE 41 give somewhat different values for effective elastic stiffness of concrete members. The effect of the different stiffness assumptions is believed to not be important in the prediction of deformation demands for beams and columns, such that either of the two recommendations should be adequate.*

8.5.4.8 Reinforced concrete beams and columns in shear

Recommendations for modeling shear strength, stiffness, and deformation capacity are provided in ASCE 41, including Supplement 1.

Commentary: *Beams and columns should be protected from excessive shear deformations through capacity design, which considers that flexural plastic hinging reduces the shear strength of beams and columns.*

8.5.4.9 Reinforced concrete slabs in slab-column frames

Chapter 4 of ATC 72 (2010) and Supplement 1 of ASCE 41 provide guidance for modeling of slab-column frames.

Commentary: *Slab-column framing can be represented using either an effective beam width model or an equivalent frame model. Where deformations exceed the yield point at a connection, it may be convenient to insert a nonlinear rotational spring between the components representing the slab and the column. In some cases it may be convenient and acceptably accurate to lump several slab-column connections into a single beam-column assembly that represents the effective stiffness and strength of several isolated connections (Yang et al. 2010).*

8.5.4.10 Reinforced concrete beam-column joints

Explicit modeling of concrete beam-column joints is not required where capacity design principles are employed to preclude joint shear failure.

Commentary: *Where Building Code provisions for joint design are followed, as is recommended by these Guidelines, it is generally acceptable to ignore joint deformations. If it is deemed desirable to include flexibility associated with joint deformations, the provisions of ASCE 41 can be used. Bond slip of longitudinal*

reinforcement in the joint region is best represented in the models of the beams and columns framing into the joint; these effects are included in the stiffness models of ASCE 41.

8.5.4.11 Reinforced concrete shear walls in bending and shear

Either fiber or moment-curvature models based on realistic cyclic material models may be used providing that excessive shear deformation is avoided by maintaining shear demands below shear capacities.

Commentary: *Both fiber and moment-curvature models can provide good representations of wall bending behavior over the full height of the wall. Shear behavior is usually decoupled from bending behavior. Coupled models (shear-flexure-axial) do exist but are difficult to implement at this time. Information on modeling of flexural and shear strength and stiffness properties of beam-column models and fiber models are presented in Chapter 4 of ATC 72 (2010). Most of the models presented in ATC 72 do not address deterioration due to longitudinal reinforcement buckling and fracture, which necessitates the specification of strain limits to account approximately for these often critical deterioration modes.*

It is often assumed that regions of a wall outside the designated yielding region can be modeled with elastic models. However, seismic force demands at the Maximum Considered Earthquake response level in tall and slender wall structures depend very much on inelastic redistribution and higher-mode effects, which might lead to large moment and shear force amplifications compared with values estimated from elastic behavior. Therefore, it is necessary to perform a comprehensive post-analysis demand/capacity review of the structure to verify that the demands in all protected regions outside the designated plastic-hinge zone are indeed small enough to justify the assumption of elastic behavior. The results might disclose the need for re-design. Alternatively, where flexural yielding is indicated in middle- or upper-story levels, it is often preferable to modify the analysis model by extending nonlinear elements over the full wall height. Minor flexural yielding often can be accommodated without significant changes to the structural design.

8.5.4.12 Reinforced concrete coupling beams

Use the modeling recommendations Chapter 4 of ATC 72 (2010) for conventionally reinforced coupling beams that are flexure controlled or for diagonally reinforced coupling beams.

Commentary: *Coupling beams that are part of the primary seismic-force-resisting system in general should be flexurally controlled or should be diagonally reinforced. Conventionally reinforced coupling beams that are shear-controlled should not be used as part of the seismic-force-resisting system. Where such components occur, they can be modeled using parameters provided by ASCE 41.*

New provisions for diagonally reinforced coupling beams are included in ACI 318-08 that allow two detailing options, one with transverse reinforcement around the groups of diagonal bars and the other with transverse reinforcement around the entire beam. Test results indicate that the load-displacement responses for the two detailing options are nearly the same.

Consideration should be given to the phenomenon that walls will “grow” on the tension side due to shifting of the neutral axis, which in turn will increase the vertical deflection at the wall-coupling beam interface and therefore will increase the coupling beam rotation demand.

8.5.4.13 Non-standard components

For components whose design and behavior characteristics are not documented in applicable Building Codes and standards, develop appropriate design criteria and component models from analytical and experimental investigations. In general, experimental verification will be necessary for proposed models for inelastic behavior including deterioration. The modeling guidance of Sections 8.5.1 to 8.5.3 should be considered in the development of analytical models and experimental validation.

8.5.4.14 Response modification devices

Model properties of response modification devices (such as seismic isolation, damping, and energy dissipation devices) based on data from laboratory tests representing the severe conditions anticipated in Maximum Considered Earthquake shaking. If there is significant variability in properties of these devices, the structure response simulations should use alternative models incorporating upper- and lower-bound properties. If there is a functional limit beyond which the devices cease to operate (for example, a displacement limit), represent this functional limit in the analytical model. It should be demonstrated either that the consequences of attaining this limit can be tolerated by the structure or that this functional limit will not be attained under 1.5 times the mean demand obtained from Maximum Considered Earthquake response analysis.

8.5.4.15 Foundation modeling

Foundation components that have significant flexibility or will experience significant inelastic behavior should be modeled following the same approach outlined for components of the superstructure.

When soil-foundation-structure interaction is accounted for in the model, evaluate the sensitivity of the predicted response to variation in important soil properties including strength and stiffness. Establish likely variability in soil properties in consultation with the geotechnical engineer.

Commentary: *Caution needs to be exercised in designing for, and modeling of, shear and bending in mat foundations. Rigorous analysis will often result in great variations of shear and bending stresses across a mat foundation, whereas it is customary practice to distribute reinforcement uniformly over a large width. This practice might underestimate the importance of local stress distributions close to concentrated loads delivered from core walls. Guidelines are under development by the ACI Task Group on Foundations.*

8.5.4.16 Foundation rocking and uplift

Foundation rocking and uplift, if indicated by the response analysis, should be modeled explicitly. The orientation and properties of springs and other elements used to account for these effects should also account for the redistribution of soil stresses and

deformations caused by changes in the contact surface between the foundation and the soil and assure transfer of axial and shear forces to the soil. The effect of varying assumptions on soil properties should be evaluated in consultation with the geotechnical engineer.

8.6 Acceptance Criteria at the Component Level

All actions (forces, moments, strains, displacements, or other deformations) are to be evaluated either as force-controlled or deformation-controlled actions. Deformation-controlled actions are those in which reliable inelastic deformation capacity is achievable without critical strength decay. Force-controlled actions are those in which inelastic deformation capacity cannot be assured. Force-controlled actions include, but may not be limited to:

Axial forces in columns (including columns in gravity frames)

Compressive strains due to flexure, axial, or combined flexure and axial actions in shear walls or piers that do not have adequate confinement

Compressive strains due to combined axial and flexural actions in shear walls or piers of shear walls where the axial demand exceeds that associated with the balance point for the cross section

Shear in reinforced concrete beams (other than diagonally reinforced coupling beams), columns, shear walls, and diaphragms

Punching shear in slabs and mat foundations without shear reinforcing

Force transfer from diaphragms and collectors to vertical elements of the seismic-force-resisting system

Connections that are not designed explicitly for the strength of the connected component (for example, brace connections in braced frames)

Commentary: *As an alternative to computing the axial demand that produces a balanced condition in a shear wall or pier, it is considered acceptable to classify such elements as deformation-controlled if they are provided with special confined boundary elements in accordance with the Building Code and if the axial demand on the element under applicable load combinations does not exceed $0.3P_o$.*

8.6.1 Force-Controlled Actions

8.6.1.1 Critical actions

Force-controlled critical actions are those force-controlled actions in which the failure mode poses severe consequences to structural stability under gravity and/or lateral loads. Force-controlled critical actions shall satisfy:

$$F_u \leq \phi F_{n,e} \quad (8-2)$$

where

F_u = the demand obtained from statistical evaluation of nonlinear response history analysis. Where the computed demand for an action is not limited by a well-defined yielding mechanism, use 1.5 times the mean. Where the computed demand for an action is limited by a well-defined yield mechanism, use the mean plus 1.3 times the standard deviation obtained from the individual response history analyses but not less than 1.2 times the mean.

$F_{n,e}$ = nominal strength as computed from applicable material codes but based on expected material properties.

ϕ = strength reduction factor obtained from applicable material standards.

Commentary: *Use of the mean value would imply a significant probability of failure with associated consequences. The use of mean plus one standard deviation ($\bar{x} + \sigma$) is more appropriate. However, when fewer than 20 ground motion pairs are used in nonlinear response history analysis, little confidence can be placed in the computed value of the standard deviation or the mean. Past studies, for example, Zareian and Krawinkler (2007) and Yang and Moehle (2008) have shown that the true coefficient of variation in force-controlled actions due to record-to-record variability is on the order of 0.4. A default value of 0.5 is used for the coefficient of variation to account for the effect of modeling uncertainties and uncertainty in the mean value.*

The use of 1.3σ , where σ is the standard deviation obtained from Maximum Considered Earthquake response analysis is permitted for specific cases, such as beam shear in a moment-resisting frame, where localized or global mechanisms may limit the force value to a rather stable maximum value and inflation to 1.5 times the mean value may be too large. This would not, in general, apply to shear in structural walls.

8.6.1.2 Noncritical actions

Noncritical actions are those force-controlled actions for which failure does not result in structural instability or potentially life-threatening damage. Force-controlled noncritical actions shall satisfy:

$$F_u \leq F_{n,e} \quad (8-3)$$

where

F_u = the mean demand obtained from the suite of analyses,

$F_{n,e}$ = nominal strength as computed from applicable material codes but based on expected material properties.

8.6.2 Deformation-Controlled Actions

If the ultimate deformation capacity (δ_u in Figure 8.1) is exceeded in any of the response history analyses, the strength associated with this mode of deformation should be assumed as zero for that analysis and the stability of the structure and the effects on related strength quantities should be evaluated.

Commentary: *To implement this criterion it is necessary to define the ultimate deformation capacity for each component. This may be done directly (see modeling Options 1 to 4 in Section 8.5.3) or indirectly by specifying strain limits in cases in which known but unquantifiable severe deterioration modes exist. For instance, the maximum concrete compressive strain in confined concrete might be limited to 0.015 and the longitudinal reinforcement strain might be limited to 0.05 in tension and 0.02 in compression in order to suppress rebar buckling and fracture. Chapter 6 of ASCE 41 and Chapters 3 and 4 of ATC 72 (2010) provide suitable recommendations for rotation and strain limits for reinforced concrete components. For steel components the recommendations for rotation limits given in Chapter 5 of ASCE 41 and Chapter 3 of ATC 72 (2010) may be used.*

8.7 Global Acceptance Criteria

Global acceptance criteria include peak transient and residual story drift and loss of story strength.

8.7.1 Story Drift

8.7.1.1 Peak transient drift

In each story, the mean of the absolute values of the peak transient drift ratios from the suite of analyses shall not exceed 0.03. In each story, the absolute value of the maximum story drift ratio from the suite of analyses shall not exceed 0.045. Drift shall be taken as the absolute maximum value of drift, regardless of direction. Cladding systems, including the cladding itself and cladding connections to the structure, shall be capable of accommodating the mean of the absolute values of the peak transient story drifts in each story.

Commentary: *The use of a story drift limit of 0.03 has resulted in efficient designs that have been judged effective by review panels in recent tall building projects. There is general consensus that up to this story drift, structures with proper yielding mechanisms and good detailing will perform well (without significant loss of strength), and that properly attached nonstructural components will not pose a major life safety hazard. The drift limit should be applied to the “total” story drift (caused by story racking and story flexural rotation) because it is intended to protect all components of the structure including the gravity system components that are surrounding shear walls or braced frames and are subjected mostly to a story shear (racking) mode of deformation. A story drift limit of 0.03 also provides P-Delta control in stories with large vertical loads.*

The maximum transient drift of 0.045 has been selected judgmentally. Nonlinear response history analysis beyond this drift limit is considered unreliable using currently available analysis tools.

When evaluating peak transient drifts, use the maximum absolute vector value of the drift in each story from each of the analyses in the suite, rather than the mean of the maximum drift in the positive direction and the maximum drift in the negative direction taken separately, and rather than the drift along defined axes without consideration of drift in the orthogonal direction.

8.7.1.2 Residual drift

In each story, the mean of the absolute values of residual drift ratios from the suite of analyses shall not exceed 0.01. In each story, the maximum residual story drift ratio in any analysis shall not exceed 0.015 unless justification is provided and accepted by the Structural Peer Review Panel.

Commentary: *The residual story drift ratio of 0.01 is intended to protect against excessive post-earthquake deformations that likely will cause condemnation or excessive downtime for a building. This criterion is added to provide enhanced performance for tall buildings.*

The limits on residual drifts also are based on concern that tall buildings with large residual drifts may pose substantial hazards to surrounding construction in the event of strong aftershocks. Repair or demolition of tall buildings with large residual drifts also may pose community risks. In each case, these limits are to be evaluated against the maximum responses calculated in any of the response histories. Larger residual drifts may be acceptable if the Structural Peer Review Panel agrees either that the large residual is due to peculiarities in the ground motion characterization, that may not be fully appropriate, or agrees that the response is reliably simulated and acceptable even given the large residual drifts.

8.7.2 Acceptable Loss in Story Strength

In any nonlinear response history analysis, deformation imposed at any story should not result in a loss of total story strength that exceeds 20% of the initial strength.

Commentary: *Component deterioration will lead to a loss in lateral and gravity-load resistance, even if deterioration occurs only in deformation-controlled actions. Since no absolute limit is placed on the deformations that can be tolerated in any one component, it is prudent to check that the loss in story resistance does not become excessive. As a general target, the loss in lateral story resistance at maximum drift should not be more than about 20% of the undeteriorated resistance.*

9 PRESENTATION OF RESULTS

9.1 General

A key element to the successful completion of a performance-based design and peer review is the documentation of the process and the presentation of the results. Key elements of this documentation include the design criteria, the design of the components of the lateral-force-resisting elements and primary gravity members, the results of the nonlinear response history analyses, and the documentation of the design in the construction documents (primarily drawings and specifications). Defining the scope and details of the results to be presented to reviewers as completely as possible at the beginning of the peer review will help to align the expectations of the various participants and lessen the chance of significant re-work by the design team. This alignment of expectations and follow-through by the design team and reviewers throughout the various phases of the project will require commitment of all parties.

The scope and detail of each presentation of information developed by the design team for review will be directly related to the phase of the project, moving from the global to the specific as the design advances from concepts to final design. At all steps in the process, highlight all assumptions that are significant to the building response, as well as items that may be outside of widely accepted standard practice or procedures or that may otherwise be controversial, and present them for specific review and comment by reviewers. Clearly state assumptions and provide discussion of the potential implications of their implementation.

Present documentation in a way that facilitates the efficient transfer of information to the reviewers. Interpretation of the results and validation of assumptions and design criteria are key elements in an effective presentation of results. More is not necessarily better. For example, presenting graphical results of key maximum response components with explanations of “what it means” is far more effective than submitting binders (or CDs) full of raw analysis data. In addition, all spreadsheets key to the structural analysis or design should be accompanied by a fully worked out example to explain the spreadsheet operations.

Another item that needs to be discussed and understood is the intended construction phasing. If an early excavation/foundation package is anticipated, this should be discussed to determine how it will impact the design and review process.

9.2 Design Criteria

The Design Criteria is the first, and in many ways the most critical document in the process. The Design Criteria is the key element in describing the design intent, primary assumptions, analyses to be performed, acceptance criteria, etc. Once agreed to by all participants, the Design Criteria becomes the rules by which subsequent design and analyses are checked. Complete and clear documentation of the Design Criteria will help avoid misunderstandings later in the process, and the potential for expensive re-work and delayed progress. Generally, the more detail included in the document, especially as related to material response and acceptance criteria, the greater the chance for an

efficient presentation and review process. Chapter 4 provides a recommended outline of Design Criteria contents.

9.3 Geotechnical/Seismic Ground Motion Report

The Geotechnical/Seismic Ground Motion Report should also be developed and reviewed in the early stages of the project. The geotechnical portion of the report, which provides design parameters for foundation elements, information on groundwater, retaining wall design pressures, etc., should basically be similar to that required for any significant design project. One item that may be included in the report and that is beyond the typical scope could be stiffness and nonlinear displacement quantities of supporting soils that can be incorporated into the building analysis model.

A properly documented ground motion report is extremely important to the success of the design process. There is continuing debate over the validity and appropriateness of many recent and ongoing developments in the procedures used in the generation of response histories for nonlinear analyses. These issues may be especially contentious for Maximum Considered Earthquake shaking levels in the long-period range of interest in tall building design, resulting in the need for extensive description of the assumptions and process followed. Spectral matching, scaling processes, use of recently developed attenuation procedures, near-field and directivity effects, hazard disaggregation, etc., all can have significant impact on the suite of response histories to be generated for use in the structural analyses and the way in which they are modified to match the target spectrum. Whenever possible, present the unmodified and modified acceleration, velocity, and displacement plots for each of the proposed response histories. This is especially important when spectral matching approaches are used to generate Maximum Considered Earthquake ground motions.

Refer to Chapter 5 for further details on the procedures to be followed and recommended contents of the Ground Motion report. Summarize this report in the Design Criteria Document, and include it in complete form as an Appendix to the Design Criteria.

9.4 Preliminary/Conceptual Design

The preliminary/conceptual design package should include a design narrative of the structural system, similar to, but potentially more fully developed than that presented in the Design Criteria Document. Present drawings for both gravity- and lateral-force-resisting systems, including preliminary member sizes, wall thicknesses, etc. Provide proposed detailing approaches for ductile elements of lateral-force-resisting system. Note special force transfers (for example, at podium and outrigger levels), and the approach to design of these elements, including sample design calculations and preliminary detailing concepts. If damping or energy dissipation elements are to be incorporated, describe assumptions used in their initial design. Provide outline specifications for structural sections, highlighting material requirements that are unusual. Provide initial design calculations used to develop member sizes, including member stiffness assumptions, period calculations, base shear capacity, etc. Provide sample capacity design calculations for major structural elements. If a full building model has

been developed, present model input and basic results (base shear, overturning moment, story drift plots, etc.).

9.5 Service Level Evaluation

Provide executive summary discussion. Re-state the response spectrum for this evaluation. Provide input model with description of elements and modeling assumptions. Provide information needed to compare model with design drawings. When response history analysis is used, provide plots of story drifts, moments, shears, and axial loads on key elements that vary with height, showing the peak quantities for each ground motion, and discussing dispersion in major response quantities. Present base shear results. Provide story drift plots and compare with design criteria limits. Provide maximum demand/capacity ratios for major structural elements. Discuss any elements that may exceed drift or capacity limits, and justify why exceeding the limits is acceptable if it is the intent to accept these. Note torsional response, if significant. Verify that results are consistent with Design Criteria Document.

9.6 Maximum Considered Earthquake Evaluation

Provide executive summary discussion. Re-state response spectrum for this evaluation. Provide input model with description of elements and modeling assumptions. Provide detailed description of nonlinear element modeling, with clear and complete discussion of assumptions. Provide information needed to compare model with design drawings. Present response history plots for acceleration, velocity, and displacement. Present base shear and overturning moment results. Provide plots of story drifts, moments, shears and axial loads on key elements that vary with height, showing the peak quantities for each ground motion, the acceptable values, and the statistical quantity of demand against which it is compared. Compare critical element deformation demands with capacity limits. Discuss any elements that may exceed drift or capacity limits. If special elements (for example, outriggers or damping or energy dissipation elements) are included in the design, provide a separate discussion of the response of these elements. Include evaluation of foundation elements and major force transfer elements/levels, such as the podium and outriggers.

10 PROJECT REVIEW

10.1 General

Because of the complexity of the analyses used to demonstrate building performance, most building departments have initiated a requirement for independent peer review when designs are submitted for permit under the alternative means and methods clause. This requirement also is included in ASCE 7 (2010). The composition of the peer review panel typically should be jointly determined by the owner/design team and the building department. Additional members of the peer review team may be added as appropriate to fully address the special features of the proposed project that are not evident at initiation of the process. There is no particular recommendation as to whether an individual person or firm, or a team of individuals and firms provides the peer review. However, the peer reviewer or reviewers should jointly possess expertise in geotechnical engineering and seismic hazards, seismic performance of tall buildings, advanced application of structural analysis software and interpretation of results, and design and behavior of structures with elements of the type employed in the subject building.

The peer review process should initiate as early in the design process as possible. Early agreement and discussion of the fundamental design decisions, assumptions, and approaches will help avoid re-work later in the design process that will impact both the project cost and schedule. With projects of the size and complexity of typical tall buildings, there may be differences of opinion on a number of issues during the process that need to be negotiated between parties. The earlier in the process that these issues can be identified and resolved, the less effect they will ultimately have on the building cost and design and construction schedule. Early participation in the peer review should also help to establish a good working relationship with the design team.

It should be noted that the existence of peer review on a project does not relieve the engineer of record from any of his/her design responsibility. However, because of the level of complexity incorporated in tall building design, in many cases it is recognized that review of these aspects of the design effectively constitutes the plan review of the seismic system (even though contracts may say that this is not the case). Peer review participation is not intended to replace quality assurance measures ordinarily exercised by the engineer of record. Responsibility for the structural design remains solely with the engineer of record, as does the burden to demonstrate conformance of the structural design to the intent of the design criteria document. The responsibility for conducting plan review resides with the building official.

The scope of peer review comments should begin with broad, general issues, and progressively move toward the more detailed. It is generally not fair to the engineer of record to bring up new general issues at later stages of the design.

Proper documentation of the peer review process is important for incorporation into the project records. It is best to develop a systematic process for establishing, tracking, and resolving comments generated by the peer review. In many cases, this takes on the form of a written spreadsheet that logs all the comments and resolutions, with dates attached. Comments that are discussed and/or any resolutions that are reached during project

review meetings or conference calls should be formally written into the project review comment spreadsheet.

The timing of reviews should be incorporated into the project design schedule in order to minimize any impact on the schedule. Periods of both review and response by the design team should be included into the project design schedule.

10.2 Reviewer Qualifications

On many projects, peer review is provided by a review team, often comprising three persons. One member is typically an expert in the generation of site-specific ground motions and accelerograms for use in the nonlinear analyses, geotechnical engineering, or geological engineering. Another member is typically a practicing structural engineer who has the expertise to review the proposed structural system, with experience in structural engineering, performance-based earthquake engineering, nonlinear response history analysis, and tall building design. This engineer's supporting staff typically performs detailed reviews of structural analysis models implemented in computer software. A third member typically possesses specialized expertise related to the proposed structural system, possibly a structural engineering researcher, with additional expertise in earthquake engineering, performance-based earthquake engineering, nonlinear response history analysis, and tall building design. There is, however, no requirement that a panel comprises three members. The number of members may be expanded or contracted as appropriate, provided the review team as a whole possesses expertise in all of the areas noted above.

Selection of reviewers is often a joint effort of the building official and the owner/design team. It is important for the selection process to obtain reviewers that have the proper background and expertise to perform the peer review, and also the time available to commit to help the process proceed in a timely manner. Reviewers should not bear a conflict of interest with respect to the project and should not be part of the project design team. The reviewers provide their professional opinion to and act under the instructions of the building official.

When review is performed by a team, one team member should serve as the review team chair and should be responsible for mediating disputes between the reviewers and the engineer of record, and for expressing the official positions and opinions of the review team. The review team chair should be a structural engineer licensed to practice in the jurisdiction in which the structure is to be constructed.

10.3 Scope

It is important to have a clear definition of the peer review scope. The building official should define the minimum acceptable scope. In most cases, the review is limited to the seismic design, even though design for wind forces and deformations (specifically drift limits for serviceability and occupant comfort) may control the design of many tall buildings. The design of gravity-load-resisting elements is typically excluded as well, except for evaluation of deformation compatibility issues. Nonstructural elements that can create hazards to life safety are often included to ensure that proper anchorage and/or deformation accommodation has been provided.

Based on the scope of review identified by the building official, the reviewers, either individually or as a team, should develop a written scope of work in their contract to provide engineering services. The scope of services should include review of the following: earthquake hazard determination, ground motion characterizations, seismic design methodology, seismic performance goals, acceptance criteria, mathematical modeling and simulation, seismic design and results, drawings, and specifications.

Commentary: *At the discretion of the building official, as well as other members of the development team, the scope of review may be expanded to include review of other building aspects, including wind design and critical non-structural elements.*

Early in the design phase, the engineer of record, the building official, and the reviewers should jointly establish the frequency and timing of review milestones, and the degree to which the engineer of record anticipates the design will be developed for each milestone.

Reviewers should provide written comments to the engineer of record and to the building official. The engineer of record should provide written responses to review comments, with multiple rounds of comment/response sometimes needed for key issues. A log should be jointly maintained by the engineer of record and the reviewers, summarizing all comments, responses to comments, and resolutions. At the conclusion of the review, the reviewers should submit a written report to the building official documenting the scope of the review, the comment log, and indicating the reviewers' professional opinion regarding the general conformance of the design to the requirements of the design criteria document. The building official may request interim reports from the reviewers at the time of interim permit reviews.

Commentary: *None of the reports or documents generated by the review are Construction Documents. Under no circumstances should letters or other documents from the review be put into the project drawings or reproduced in any other way that makes review documents appear to be part of the Construction Contract Documents. The engineer of record is solely responsible for the Construction Contract Documents. Documents from the reviewers should be retained as part of the building department project files.*

10.4 Dispute Resolution

Given the complexity of tall buildings and the performance-based analyses being performed, it is not uncommon for disagreements to arise between the engineer of record and the reviewers. Generally, these disagreements fall into one of two categories. The first is regarding the level of complexity of analysis/evaluation that has been performed to validate an aspect of the design. In most cases, this should be resolvable with additional analyses, confirming studies, etc. The second case is related to differences of opinion in the interpretation of results, specifically as to whether or not elements of the design criteria have been met. Resolution of such issues may be obtained through sensitivity analyses, bounding analyses, or other means.

If cases arise where disputes between the engineer of record and reviewers are not resolved, the building official is required to "break the tie." The building official can do so based on his/her knowledge of the situation or, in some cases, may retain other experts to review the material and generate a recommended course of action.

For jurisdictions that have a significant number of tall building projects incorporating performance-based design procedures, establishment of an advisory board should be considered. An advisory board should consist of individuals who are widely respected and recognized for their expertise in relevant fields, including, but not limited to, structural engineering, performance-based design, nonlinear analysis techniques, and geotechnical engineering. The advisory board members may be elected to serve for a predetermined period of time on a staggered basis. The advisory board may oversee the design review process across multiple projects periodically, assist the building official in developing criteria and procedures spanning similar design conditions, and resolve disputes arising under peer review.

10.5 Post-review Revision

Because of the fast-track nature of many modern large building projects, it should be expected that significant changes to the design may occur during the final stages of design and/or the construction phase. In this event, the engineer of record should inform the building official, describing the changes to the structural design, detailing, or materials made subsequent to the completion of peer review. At the discretion of the building official, such changes may be subject to additional review by the peer review team and approval by the building official.

REFERENCES

Abrahamson, N.A., and W.J. Silva (2008). "Summary of the Abrahamson and Silva NGA ground motion relations," *Earthquake Spectra*, 24 (1), 67-97.

ACI 318 (2008). *Building Code Requirements for Structural Concrete (ACI 318-08) and Commentary*, American Concrete Institute, Farmington Hills, MI.

Atkinson, G.M., and D.M. Boore (2003). "Empirical ground motion relations for subduction earthquakes and their application to Cascadia and other regions," *Bulletin of the Seismological Society of America*, 93, p. 1703-1729.

Atkinson, G.M., and D.M. Boore (2008). "Erratum to Atkinson and Boore (2003)," *Bulletin of the Seismological Society of America*, 98, p. 2567-2569.

AISC 341 (2010). *Seismic Provisions for Structural Steel Buildings*, American Institute of Steel Construction, Chicago, IL.

AISC 360 (2010). *Specification for Structural Steel Buildings*, American Institute of Steel Construction, Chicago, IL.

AISC (2006). "Steel Plate Shear Walls," *Steel Design Guide 20*, R. Sabelli and M. Bruneau, American Institute of Steel Construction, Inc.

ASCE 41 (2007). *Seismic Rehabilitation of Existing Buildings (ASCE/SEI 41/06 plus Supplement 1)*, American Society of Civil Engineers, Reston, VA, 416 pp.

ASCE 7 (2010). *Minimum Design Loads for Buildings and Other Structures (ASCE/SEI 7-10)*, American Society of Civil Engineers, Reston, VA.

ATC 63 (2008). "ATC-63: Quantification of Building Seismic Performance Factors," ATC-63 90% Draft, Applied Technology Council, Redwood City, California.

ATC 72 (2010). "ATC-72-1: Interim Guidelines on Modeling and Acceptance Criteria for Seismic Design and Analysis of Tall Buildings," ATC-72-1, Applied Technology Council, Redwood City, California.

Baker J.W., and C.A. Cornell (2005). "A vector-valued ground motion intensity measure consisting of spectral acceleration and epsilon," *Earthquake Engineering and Structural Dynamics*, 34 (10), 1193-1217.

Baker J.W., and C.A. Cornell (2006). "Spectral shape, epsilon and record selection," *Earthquake Engineering and Structural Dynamics*, 35 (9), 1077-1095.

Boore, D.M., and G.M. Atkinson (2008). "Ground motion prediction equations for the average horizontal component of PGA, PGV, and 5%-damped PSA at spectral periods between 0.01 and 10.0 s," *Earthquake Spectra*, 24 (1), 99-138.

Campbell, K.W., and Y. Bozorgnia (2008). "NGA ground motion model for the geometric mean horizontal component of PGA, PGV, PGD, and 5%-damped linear elastic response spectra for periods ranging from 0.01 to 10 s," *Earthquake Spectra*, 24 (1), 139-171.

Chiou, B.S.-J. and R.R. Youngs (2008). "Chiou and Youngs PEER-NGA empirical ground motion model for the average horizontal component of peak acceleration and pseudo-spectral acceleration for spectral periods of 0.01 to 10 seconds," *Earthquake Spectra*, 24 (1), 173-215.

Crouse, C.B. (1991a). "Ground motion attenuation equations for earthquakes on the Cascadia subduction zone," *Earthquake Spectra*, 7, p. 201-236.

Crouse, C.B. (1991b). "Errata to Crouse (1991a)," *Earthquake Spectra*, 7, p. 506.

Elgamal, A-W., M. Zeghal, and E. Parra (1996). "Liquefaction of reclaimed island in Kobe, Japan," *ASCE Journal of Geotechnical Engineering*, 122 (1), p. 39-49.

Elwood, K.J., and M.O. Eberhard (2009). "Effective Stiffness of Reinforced Concrete Columns," *ACI Structural Journal*, V. 106, No. 4, pp. 476-484.

Elwood, K.J., A.B. Matamoros, J.W. Wallace, D.E. Lehman, J.A. Heintz, A.D. Mitchell, M.A. Moore, M.T. Valley, L.N. Lowes, C.D. Comartin, and J.P. Moehle (2007). "Update to ASCE/SEI 41 Concrete Provisions," *Earthquake Spectra*, EERI, 23 (3), pp. 493–523.

Fell, B.V., A.M. Kanvinde, G.G. Deierlein, A.M. Myers, and X. Fu (2006). "Buckling and fracture of concentric braces under inelastic cyclic loading." *Steel/TIPS*, Technical Information and Product Service, Structural Steel Educational Council. Moraga, CA.

Fell, B.V. (2008). "Large-Scale Testing and Simulation of Earthquake-Induced Ultra Low Cycle Fatigue in Bracing Members Subjected to Cyclic Inelastic Buckling," Ph.D. Dissertation, University of California, Davis.

FEMA 440 (2005). "Improvement of Nonlinear Static Seismic Analysis Procedures," *Report No. FEMA 440*, Federal Emergency Management Agency, 392 pp.

FEMA 450 (2003). "NEHRP Recommended Provisions and Commentary for Seismic Regulations for New Buildings and Other Structures," *Report No. FEMA 450*, Federal Emergency Management Agency, 712 pp.

FEMA P750 (2009). "NEHRP Recommended Provisions for Seismic Regulation of Buildings," *Report No. FEMA P750*, Building Seismic Safety Council, Federal Emergency Management Agency, Washington, D.C.

Field, E.H., T.H. Jordan, and C.A. Cornell (2003). "OpenSHA: A Developing Community-Modeling Environment for Seismic Hazard Analysis," *Seismological Research Letters*, Seismological Society of America, 74, 406-419.

Goel, R.K., A.K. Chopra (1997). "Vibration Properties of Buildings Determined from Recorded Earthquake Motions," *Report No. UCB/EERC-97/14*, University of California, Berkeley, 271 pp.

Goulet, C.A., C.B. Haselton, J. Mitrani-Reiser, J.L. Beck, G.G. Deierlein, K.A. Porter, and J.P. Stewart (2007). "Evaluation of the seismic performance of a code-conforming reinforced-concrete frame building - from seismic hazard to collapse safety and economic losses," *Earthquake Engineering and Structural Dynamics*, 36 (13), 1973-1997.

Goulet, C. and J.P. Stewart, (2009). "Pitfalls of deterministic application of nonlinear site factors in probabilistic assessment of ground motions," *Earthquake Spectra*, 25 (3), 541-555.

Griffis, L. (1993). "Serviceability Limit States Under Wind Loads", *Engineering Journal*, American Institute of Steel Construction, First Quarter.

Hamburger, R.O., H. Krawinkler, J.O. Malley, and S.M. Adan (2009). "Seismic Design of Steel Special Moment Frames: A Guide for Practicing Engineers," *NEHRP Seismic Design Technical Brief No. 2, NIST GCR 09-917-3*, National Institute of Standards and Technology, Gaithersburg, MD.

IBC (2009). *International Building Code*, International Code Council, Washington, DC.

Idriss, I.M. (2008). "An NGA empirical model for estimating the horizontal spectral values generated by shallow crustal earthquakes," *Earthquake Spectra*, 24 (1), 217-242.

Jin, J., and S. El-Tawil (2003). "Inelastic cyclic model for steel braces." *Journal of Engineering Mechanics*, ASCE, 129(5), 548-557.

Klemencic, R., J.A. Fry, G. Hurtado, and J.P. Moehle (2006). "Performance of Post-Tensioned Slab-Core Wall Connections," *PTI Journal*, 4 (6), pp. 7-23.

Leyendecker, E.V., R.J. Hunt, A.D. Frankel, and K.S. Rukstales (2000). "Development of maximum considered earthquake ground motion maps," *Earthquake Spectra*, 16 (1), 21-40.

McGuire, R.K. (2004). *Seismic Hazard and Risk Analysis*, Earthquake Engineering Research Institute.

Moehle, J.P., J.D. Hooper, D.J. Kelly, and T.R. Meyer (2010). "Seismic design of cast-in-place concrete diaphragms, chords, and collectors: a guide for practicing engineers," *NEHRP Seismic Design Technical Brief No. 3, NIST GCR 10-917-4*, National Institute of Standards and Technology, Gaithersburg, MD.

Moehle, J.P., J.D. Hooper, and C.D. Lubke (2008). "Seismic Design of Reinforced Concrete Special Moment Frames: A Guide for Practicing Engineers," *NEHRP Seismic Design Technical Brief No. 1, NIST GCR 8-917-1*, National Institute of Standards and Technology, Gaithersburg, MD.

Petersen, M.D., A.D. Frankel, S.C. Harmsen, C.S. Mueller, K.M. Haller, R.L. Wheeler, R.L. Wesson, Y. Zeng, O.S. Boyd, D.M. Perkins, N. Luco, E.H. Field, C.J. Wills, and K.S. Rukstales (2008). "Documentation for the 2008 Update of the United States National Seismic Hazard Maps," *U.S. Geological Survey Open-File Report 2008-1128*, 61 p.

Power, M., B. Chiou, N. Abrahamson, Y. Bozorgnia, T. Shantz, and C. Roblee (2008). "An overview of the NGA project," *Earthquake Spectra*, 24(1), 3-21.

Satake, N., K. Suda, T. Arakawa, A. Sasaki, and Y. Tamura (2003), "Damping Evaluation Using Full-Scale Data of Buildings in Japan," *JSCE*, 129(4), 470-477.

Stewart, J.P., S.-J. Chiou, J.D. Bray, P.G. Somerville, R.W. Graves, and N.A. Abrahamson (2001). "Ground motion evaluation procedures for performance based design," *Report No. PEER-2001/09*, Pacific Earthquake Engineering Research Center, University of California, Berkeley, 229 pp.

TBI (2010). The Tall Buildings Initiative, Pacific Earthquake Engineering Research Center, <http://peer.berkeley.edu/tbi/index.html>.

Uriz, P. (2005). "Towards earthquake resistant design of concentrically braced steel structures." Ph.D. Dissertation, University of California, Berkeley.

Uriz, P., F.C. Filippou, and S.A. Mahin (2008). "Model for cyclic inelastic buckling of steel braces." *Journal of Structural Engineering*, ASCE, 134(4), 619-628.

Yang, T.Y., G. Hurtado, and J.P. Moehle (2010). "Seismic Behavior and Modeling of Flat-Plate Gravity Framing in Tall Buildings," Proceedings, 9th US National Conference on Earthquake Engineering, Toronto.

Yang, T.Y., and J.P. Moehle (2008). "Shear in Walls," unpublished presentation at the 2008 meeting of the Los Angeles Tall Buildings Structural Design Council, Los Angeles.

Youd, T.L., and B.L. Carter (2005). "Influence of soil softening and liquefaction on spectral acceleration," *Journal of Geotechnical and Geoenvironmental Engineering*, 131 (7), 811-825.

Youngs, R.R. S.-J. Chiou, W.J. Silva, and J.R. Humphrey (1997). "Strong ground motion attenuation relationships for subduction zone earthquakes," *Seismological Research Letters*, Seismological Society of America, 68 (1), pp. 58-73.

Zareian, F., H. Krawinkler (2007). "Assessment of probability of collapse and design for collapse safety," *Earthquake Engineering and Structural Dynamics*, 36(13), 1901-1914.

Zeghal, M. and A-W. Elgamal (1994). "Analysis of site liquefaction using earthquake records," *Journal of Geotechnical Engineering*, ASCE, 120 (6), p. 996-1017.

Zhao, J., J. Zhang, A. Asano, Y. Ohno, T. Oouchi, T. Takahashi, H. Ogawa, K. Irikura, H.K. Thio, P. Somerville, and Y. Fukushima (2006). "Attenuation relations of strong ground motion in Japan using site classification based on predominant period," *Bulletin of the Seismological Society of America*, 96, p. 898-913.

The Pacific Earthquake Engineering Research Center (PEER) is a multi-institutional research and education center with headquarters at the University of California, Berkeley. Investigators from over 20 universities, several consulting companies, and researchers at various state and federal government agencies contribute to research programs focused on performance-based earthquake engineering.

These research programs aim to identify and reduce the risks from major earthquakes to life safety and to the economy by including research in a wide variety of disciplines including structural and geotechnical engineering, geology/seismology, lifelines, transportation, architecture, economics, risk management, and public policy.

PEER is supported by federal, state, local, and regional agencies, together with industry partners.



PEER reports can be ordered at http://peer.berkeley.edu/publications/peer_reports.html or by contacting

Pacific Earthquake Engineering Research Center
University of California, Berkeley
325 Davis Hall, mail code 1792
Berkeley, CA 94720-1792
Tel: 510-642-3437
Fax: 510-642-1655
Email: peer_editor@berkeley.edu

ISSN 1547-0587X



PEER

**Report No. 2010/05
November 2010
<http://peer.berkeley.edu>**