

**Seismic Qualification and Fragility Testing of Line Break 550 kV  
Disconnect Switches**

**Shakhzod M. Takhirov**

Pacific Earthquake Engineering Research Center  
University of California, Berkeley

**Gregory L. Fenves**

Department of Civil and Environmental Engineering  
University of California, Berkeley

**Eric Fujisaki**

Pacific Gas and Electric Company  
Oakland, California

PEER Report 2004/xx  
Pacific Earthquake Engineering Research Center  
University of California, Berkeley

## **ABSTRACT**

The objective of the study is to conduct seismic qualification and fragility testing of a single pole of 550-kV porcelain disconnect switch. Due to clearance limitations above the shaking table the switch with the main blade in open position could not be tested in a typical field installation; therefore, several switch configurations were developed for testing. The 550-kV disconnect switch is tested in three configurations: mounted on typical 14 ft tall supports, mounted on a short 4-in spacer to simulate flexibility of the top plates of the supports, and rigidly fixed to the earthquake simulation platform. In the two latter configurations the switch is tested with the main blade in open and closed positions, and these configurations are used for seismic qualification testing of the open-blade switch and in the experimental study for amplification factor estimation.

Tri-axial tests of a single pole of the porcelain disconnect switch mounted on elevated supports are conducted by means of IEEE-compatible time history to determine its dynamic properties and to qualify the switch to the high Performance Level. A feasibility of seismic qualification testing of tall electrical equipment with supports removed by introduction of an amplification factor due to the supports is also studied experimentally. Tri-axial time history tests of a single pole of porcelain disconnect switch mounted without the tall supports on the simulator platform is conducted to determine the dynamic properties of the pole and to evaluate its seismic response. A seismic qualification test for the switch in open blade position on the earthquake simulator platform (mounted without the tall supports) by means of use the amplification factor is performed.

In addition, the main objective of the study includes static and dynamic testing of switch components (the tall supporting legs and the insulator posts) and a study of feasibility to replace the blade with an equivalent shorter blade or a concentrated mass for seismic qualification testing of tall electrical equipment that cannot accommodate clearance above the table. The component testing also includes static cantilever tests on insulator posts to determine failure modes and equivalent cantilever loads in failure for the ceramic insulators used in the switch.

## ACKNOWLEDGMENTS

This project was sponsored by the Pacific Earthquake Engineering Research Center's Program of Applied Earthquake Engineering Research of Lifeline Systems supported by the California Energy Commission, California Department of Transportation, and the Pacific Gas & Electric Company. This financial support is gratefully acknowledged.

The authors would like to acknowledge Southern States, Inc., (Hampton, Georgia) for donating the 550-kV switch. The authors wish to thank the following individuals of the company for their extremely valuable technical contributions to the project: Mr. Cary Ahrano and his Southern States staff for rapid assembly and disassembly of the switch on the shaking table and providing constant technical support at all stages of the experimental study. Special thanks due to NGK-Locke, Inc. (Baltimore, Maryland) for donating number of insulator posts to be used in the final fragility tests; the authors would like to thank the company for the valuable technical support and discussion of fragility tests results. The authors would like to thank Valmont Industries, Inc., (Omaha, Nebraska) for donating the steel supports. Special thanks due to Mr. Don Clyde of PEER who made significant contributions to the experimental program. Thanks are also due to Mr. Wesley Neighbour of PEER and Mr. David MacLam of PEER for their help in the shaking table testing, Ms. Janine Hannel of PEER for editing this report. The authors would like to also acknowledge Mr. Craig Riker of SDG&E, Mr. Philip Mo of Southern California Edison, Dr. Anshel Schiff, and members of the Utility Consortium for active participation in test plan development, discussion of the test results and witnessing the testing procedure.

This work made use of the Earthquake Engineering Research Centers Shared Facilities supported by the National Science Foundation under award number EEC-9701568 through the Pacific Earthquake Engineering Research Center (PEER). Any opinions, findings, and conclusion or recommendations expressed in this material are those of the author(s) and do not necessarily reflect those of the National Science Foundation.

**CONTENTS (PAGES TO BE CORRECTED LATER)**

**ABSTRACT..... iii**  
**ACKNOWLEDGMENTS ..... iv**  
**TABLE OF CONTENTS .....v**  
**LIST OF FIGURES ..... vii**  
**LIST OF TABLES ..... ix**

**1 INTRODUCTION .....1**

1.1 Overview ..... 1

1.2 Review of Previous Research ..... 2

1.3 Objectives of Study ..... 2

1.4 Report Organization ..... 2

**2 TESTING PROCEDURE FOR QUALIFICATION TESTING .....1**

2.1 Major Components of Single Pole Switch and Experimentation Setup ..... 1

2.1.1 Static Fragility Tests for Insulator Posts ..... 18

2.1.2 Switch Configurations Tested in the Study ..... 18

2.1.3 Instrumentation ..... 18

2.2 Experimental Program ..... 2

2.2.1 Qualification Testing..... 18

2.2.2 Experimental Study on Feasibility of Testing without Support Structure ..... 18

2.2.3 Experimental Study on Feasibility of Testing with Blade Removed or Shorten 18

2.3 Input Time Histories for Earthquake Simulator..... 2

2.3.1 Resonance Search Tests ..... 18

2.3.2 Time-History Shake Table Tests ..... 18

**3 COMPONENT TESTING PRIOR TO AND AFTER QUALIFICATION TESTS .....1**

3.1 Static and Free Vibration Tests for 14’ Supports..... 5

3.1.1 Stiffness Test for Support with Leveling Rods ..... 18

3.1.2 Stiffness Test and Man Excitation for Support without Leveling Rods ..... 18

3.1.2 Conclusions ..... 18

3.2 Static and Free Vibration Tests for Insulators..... 8

3.2.1 Calibration and Stiffness Tests for Porcelain Sections and Assembled Posts .. 18

3.2.2 Static Fragility Tests for Insulator Posts ..... 18

3.2.3 Data Provided by Insulator Manufacturer (Courtesy to NGK Insulators, Ltd). 18

|          |   |           |
|----------|---|-----------|
| 3.2.4    | Design Properties of Ceramics.....  | 18        |
| 3.2.5    | Conclusions.....  | 18        |
| <b>4</b> | <b>SUPPORT MOUNTED SWITCH WITH EXISTING DESIGN.....</b>                     | <b>22</b> |
| 4.1      | Switch Response at Low-Level Dynamic Testing.....                           | 22        |
| 4.1.1    | Experimental Program.....   | 22        |
| 4.1.2    | Summary on Static Pullback, Free Vibration, and Resonance Search Tests....  | 22        |
| 4.1.3    | Equivalent Cantilever Loads in Insulator Posts During Time-History Tests... | 22        |
| 4.1.4    | Details of Design Improvements in Modified Switch.....                      | 22        |
| <b>5</b> | <b>QUALIFICATION TESTS FOR MODIFIED SWITCH ON SUPPORTS.....</b>             | <b>30</b> |
| 5.1      | Stiffness, Resonance Frequency, and Damping.....                            | 53        |
| 5.2      | Time History Testing.....   | 53        |
| 5.2.1    | Test Response Spectra at Various Severity Levels of Testing.....            | 53        |
| 5.2.2    | Equivalent Cantilever Load in Insulator Posts.....                          | 54        |
| 5.2.3    | Summary on Other Monitored Data.....  | 39        |
| 5.2.4    | Electrical Continuity and Resistance Checks.....                            | 54        |
| 5.2.5    | Minor Anomalies after PL test at 1.0g Target pga.....                       | 39        |
| 5.3      | Summary and Conclusions.....  | 59        |
| 5.2.1    | RRS Enveloping and Tolerance Zone Criteria.....                             | 59        |
| 5.2.2    | Qualification Testing Acceptance Criterion Related to PL Testing.....       | 60        |
| <b>6</b> | <b>QUALIFICATION TESTS FOR MODIFIED SWITCH IN OPEN POSITION</b>             |           |
|          | <b>WITHOUT SUPPORTS.....</b>  | <b>30</b> |
| 6.1      | Estimation of Amplification Factor.....                                     | 30        |
| 6.1.1    | Three Configurations of Disconnect Switch with Main Blade Closed.....       | 30        |
| 6.1.2    | Resonance Frequency and Damping for Three Configurations.....               | 34        |
| 6.1.3    | Amplification Factor Based on Critical Loads Ratio.....                     | 34        |
| 6.2      | Seismic Qualification Testing Of Disconnect Switch in Open Position.....    | 38        |
| 6.2.1    | Resonance Frequency and Damping of Spacer Mounted Switch in Open            |           |
| Position | 38  |           |
| 6.2.2    | Time History Testing of Spacer Mounted Switch in Open Position.....         | 39        |
| 6.2.3    | Summary on Other Monitored Data.....  | 39        |
| 6.2.4    | Electrical Continuity and Resistance Checks.....                            | 39        |
| 6.2.5    | Minor Anomaly after 1.17g Target pga Testing.....                           | 39        |

|  |  |           |
|--|--|-----------|
| 6.3  | Summary and Conclusions.....   | 59        |
| 6.2.1  | RRS Enveloping and Tolerance Zone Criteria.....                              | 59        |
| 6.2.2  | Qualification Testing Acceptance Criterion Related to PL Testing .....       | 60        |
| <b>7</b>   | <b>FEASIBILITY STUDY ON BLADE REPLACEMENT BY EQUIVALENT MASS</b>             |           |
|  | <b>OR SHORTEN BLADE .....</b>  | <b>30</b> |
| 7.1  | Tests with Equivalent Mass Replacing Blade.....                              | 5         |
| 7.1.1  | Equivalent Mass Selection.....   | 15        |
| 7.1.2  | Summary on Low Level Dynamic Testing of Switch with Mass Replacing<br>Blade  | 15        |
| 7.2  | Tests with Equivalent Shorten Blade.....                                     | 6         |
| 7.2.1  | Design of Shorten Blade .....  | 6         |
| 7.2.2  | Resonance Frequency.....   | 15        |
| 7.3  | Summary and Conclusions.....   | 6         |
| <b>8</b>   | <b>SUMMARY AND CONCLUSIONS.....</b>  | <b>30</b> |
| 9.1  | Component Testing.....   | 5         |
| 8.2  | Switch with Original Design.....   | 6         |
| 8.3  | Qualification Testing of Support Mounted Switch (Blade Closed).....          | 6         |
| 8.4  | Qualification Testing of Spacer Mounted Switch (Blade Open).....             | 6         |
| 8.5  | Feasibility of Blade Replacement with Equivalent Mass or Shorten Blade ..... | 6         |
| <br>   |  |           |
| <b>APPENDIX A: IEEE 693 Specifications and New Recommendations for Seismic</b> |  |           |
|  | <b>Qualification Testing .....</b>   | <b>43</b> |
| <b>APPENDIX B: Complete List of All Test Steps Performed .....</b>             |  |           |
|  |  | <b>43</b> |
| <b>APPENDIX C: Finite Element Analysis of Supports .....</b>                   |  |           |
|  |  | <b>43</b> |

## LIST OF FIGURES

Fig. 2.1 Los Angeles and Orange counties by census tracts .....7

## LIST OF TABLES

|           |  |   |
|-----------|--|---|
| Table 1.1 | Joint design example for Specimen B1 ..... | 3 |
|-----------|--|---|



# 1 Introduction

## 1.1 OVERVIEW

Disconnect switches are key components of power transmission and distribution (T&D) systems. They are used to control the flow of electricity between substation equipment and are used to isolate substation equipment for maintenance. Figure 1.1 shows an elevated three-phase (pole) vertical-break disconnect switch. At either terminal, the switch is connected to stiff aluminum bus tubes that are attached to bus supports consisting of insulators and steel tube structures. The aluminum bus tubes and their supports can be seen in the figure.

In general, disconnect switches consist of three poles (or phases), each consisting of two or three insulator posts. The insulators are either porcelain or composite polymers. Cast or extruded aluminum is used for most of the live (current-carrying) parts. Base and operation-mechanism hardware is generally manufactured from structural or alloy steel or ductile iron. Disconnect switches are typically mounted on support structures to provide sufficient clearance to the ground, and to integrate them into the design of the substation.

For the switch tested as part of this study, the pole consists of three insulator posts that are mounted on the switch base, which is in turn, attached to 14 ft tall tapered steel supports. The pole's main blade mounted on top of the posts, provides control of the electrical connection. In addition to the main blade each pole of a grounding switch has a grounding blade that grounds the pole during maintenance procedures. A crank and inter-pole linkages operate the main and grounding blades and synchronize the operation of the three poles. Typically, the mechanical operation of the switch is achieved by means of a motor mechanism that provides remote control powered operation of disconnect switches in large switchyards. Gang-operated, manually controlled switches are also used by some utilities. The main blade of the pole tested as a part of this study opens in-plane of the pole, so the switch is termed a vertical-break line type switch.

There are limitations on the geometric size of a test specimen intended for a seismic qualification testing on an earthquake simulator. In order to accommodate these limits only one pole of the switch is used for the experimental study that is referenced simply as a switch further in the discussion.



Fig. 1.1 Typical field installation of 500-kV disconnect switch consisting of 3 poles.

Recent major earthquakes in the United States (e.g., Northridge, California, 1994) and other parts of the world (e.g., Taiwan 1999) have demonstrated that the reliability of a power transmission and distribution system in a seismically active region is dependent upon the seismic response of its individual components. Porcelain disconnect switches have frequently suffered two types of failures in past earthquakes: structural damage (e.g., fracture of brittle components) and loss of functionality (e.g., switch blades not operating correctly), although numerous other types of failures have also been observed. Additional information on the seismic performance of disconnect switches may be found in Schiff, 1999. Since disconnect switches form an important

part of power T&D systems, their structural and electrical integrity are critical to maintaining operability of the electrical power grid after a major earthquake.

To mitigate the vulnerability of new disconnect switches and other electrical substation equipment in the United States, the Institute for Electrical and Electronics Engineers (IEEE), developed guidelines for seismic testing and qualification of substation equipment, including disconnect switches. These guidelines are described in IEEE Recommended Practices for Seismic Design of Substations, IEEE 693-1997. The key IEEE 693-1997 requirements for seismic qualification tests and new recommendations developed in a companion study (Takhirov, et al, 2004) are summarized in Appendix A.

## 1.2 REVIEW OF PREVIOUS RESEARCH

The literature contains limited information on the seismic performance of disconnect switches and their response to strong motion time histories compatible with the IEEE spectra, including tests on switches mounted on full-size supports replicating field installations. This section summarizes the available literature related to dynamic testing of disconnect switches.

*Seismic Qualification Testing of 500-kV Switch at Wyle.* Seismic qualification testing conducted in 1984 on a 500-kV vertical break disconnect switch is discussed in a report from Wyle Laboratories (Wyle Laboratories, 1993). The switch was only subjected to resonance search and sine beat testing using the Wyle Biaxial Seismic Simulator and with a relatively stiff supporting system. The specimen was subjected to input motions along its longitudinal axis, and for subsequent tests the specimen was rotated 90 degrees in the horizontal plane. The sine-beat tests consisted of 10 simultaneous horizontal and vertical oscillations per beat with a time pause of approximately 2 seconds between each of five beats.

The switch had the lowest resonant frequency in transverse direction with the switch in open position, estimated as 1.25 Hz, with damping ratio of about 6%. The second resonance frequency in transverse direction was 3.2 Hz (3.4 Hz in parallel direction) in blade open configuration with damping ratio of about 3% (4% damping in parallel direction). The lowest frequency in parallel direction was 1.4 Hz (blade) with damping ratios around 7% (blade open configuration). The fundamental frequencies in blade-closed configuration were around 3.0 Hz for both transverse and parallel directions with damping ratios around 4%.

*Seismic Qualification Testing of 230-kV Switch at Wyle.* Experimental study on the qualification of a 230-kV switch is presented in another report by Wyle Laboratories

(Thornberry and Hardy 1997). The scope was limited to switch testing and qualification. No fragility data were collected and no conclusions were drawn regarding the seismic performance of the switch. The elevated switch was attached to the biaxial simulator using bolted connections. The specimen was tested initially along its longitudinal and vertical axes. It was then rotated 90 degrees and tested along its lateral and vertical axes. Resonant-search, sine-beat, and bi-directional seismic simulation tests were conducted to characterize the dynamic properties of the switch. Spectrum-compatible random motions rather than earthquake histories were used for the earthquake-simulation tests. The switch had a fundamental frequency of between 5 and 6 Hz and a damping ratio of between 2 and 4 % of critical.

***Seismic Testing of 230-kV Switches at PEER.*** A comprehensive experimental study of 230-kV disconnect switches was conducted at the Pacific Earthquake Engineering Research Center (Gilani, et al 2000). The study focused on seismic qualification testing of the 230-kV switches subjected to the IEEE-compatible strong motion time histories. The poles were tested in two configurations: mounted directly to the earthquake simulator, and on a low-profile braced stiff frame. Sine-sweep and white noise tests were used to calculate the modal frequencies and damping ratios for the poles in both configurations.

The earthquake histories used for the qualification and fragility testing of the 230-kV bushings were developed using the three-component set of near-field earthquake motions recorded during the 1978 Tabas earthquake. Two independent sets of three-component earthquake histories (Tabas-1 and Tabas-2) were generated to envelop the entire IEEE spectrum over two frequency bands. Since it is impractical to qualify the switches on all possible mounting frames, a low-profile braced frame was used for testing. The process of qualification therefore involved the use of two sets of earthquake histories and two blade positions (open and closed).

Five disconnect switches were evaluated by analysis and experimentation in this study. One type was ABB Type DR9 porcelain horizontal-break 230-kV switch. The insulator posts were bolted to ductile iron rotor bearing housings that were bolted to a double-channel beam. Second type was ABB Type TTR-8 vertical-break 230-kV switch with some variations in design details and insulator material: porcelain insulators mounted on aluminum spacers, the cast aluminum spacers replaced by welded steel spacers, and composite polymer insulators with single hollow core with both aluminum and steel spacers.

The vertical-break switches that were mounted on welded steel spacers survived tests with earthquake histories whose spectral ordinates equaled or exceeded the IEEE 693-1997

spectrum for High Seismic Performance Level qualification (peak acceleration equal to 1.0g). Because the test frame was of similar stiffness to the low-profile braced frame that was proposed for new construction at PG&E, it was concluded that the switches should be considered to be qualified to the High Level for use on the PG&E braced frame.

### **1.3 OBJECTIVES OF STUDY**

The lack of information on tri-axial seismic qualification and fragility testing of 500-kV disconnect switches motivated the study described in this report. The objectives are to:

1) Conduct resonant-search and tri-axial time history tests of a single pole of porcelain disconnect switch mounted on elevated supports to determine its dynamic properties, to qualify the switch to the High Performance Level (PL) if possible, or to determine the failure modes.

2) Study the feasibility of seismic qualification testing of tall electrical equipment with supports removed by use of an amplification factor, and experimentally and theoretically investigate a technique to estimate the amplification factor.

3) Conduct resonant-search and triaxial time history tests of a single pole of porcelain disconnect switch mounted directly on the simulator platform to determine the dynamic properties of the pole and to evaluate its seismic response. Conduct a seismic qualification test for the switch in open blade position on the earthquake simulator platform by use the amplification factor.

4) Conduct comprehensive testing and calibration of switch components, including supporting legs and insulator posts.

5) Conduct detailed study of seismic qualification testing for the switch with main contact open and feasibility of replacing the blade with an equivalent shorter blade or concentrated mass.

6) In case the switch passes the High PL test, conduct cantilever test on insulator posts to determine failure modes and failure equivalent cantilever loads for the ceramic insulators.

### **1.4 REPORT ORGANIZATION**

This report is organized as follows. Chapter 2 provides information on the seismic qualification testing procedure used during the study, including test setup and instrumentation, switch configurations tested, experimentation program, input strong motion time histories that accommodate the capacity of the earthquake simulator (shaking table) at the University of

California, Berkeley. This report focuses on the response and performance of the switch to strong earthquake motions. Qualification activities referred to in this report may include activities required by IEEE 693-1997, which is the version of the standard currently in force, as well as practices recommended for use in Takhirov, et al, 2004, which deals with the development of input motions for testing. It should be noted that the practices recommended in the latter reference do not, at present, constitute a part of the IEEE 693 standard. Qualification of the switch is discussed in greater detail in a separate report to be developed by the switch manufacturer.

Chapter 3 discusses the results of experimental study conducted on components of the switch prior to and after the seismic qualification tests. The typical 14 ft tall supports are tested with and without leveling rods. Based on experimental data an elastic stiffness of the support from a static pull-back test, a natural frequency and a damping from a free-vibration test are estimated. Similar procedure is followed for the insulator posts. A stiffness before and after the qualifications tests and a natural frequency and a damping after the tests are computed based on porcelain post and section testing. The component-testing program is concluded by static cantilever tests of all insulator posts used in the switch assembly during the qualification tests.

Chapter 4 discusses the test results for a switch with unreinforced base called Original Switch; the tests are conducted only at low level up to 0.25g pga. Since the equivalent cantilever loads in the insulator posts at 0.25g pga are appeared to be greater than the allowable loads, the base of the switch is reinforced in order to proceed to more severe dynamic testing and seismically qualify the switch at higher level. The major part of the experimental study is conducted for the switch with the reinforced base that is called Modified Switch and the test results are discussed in the next chapters.

Chapter 5 follows the requirements of IEEE 693 (IEEE, 1998) on a qualification testing of electrical equipment by means of earthquake simulator, and it presents results of seismic qualification of Modified Switch mounted on supports. Seismic qualification testing of the disconnect switch mounted on the supporting structure is conducted with the main blade in closed position due to clearance limitations above the earthquake simulator platform.

Chapter 6 presents results and discussions related to estimation of amplification factor due supporting structure and seismic qualification testing of the disconnect switch in open position. To qualify the disconnect switch in open blade position, the switch is tested without the supports by introduction of amplification factor to represent an elevated mounting. The

qualification testing of the switch with open blade position, the switch mounted on short spacers is subjected to a time history scaled by the amplification factor.

Chapter 7 presents results and discussions related to a feasibility study of replacing the blade with an equivalent mass or a shortened blade. The switch with an equivalent mass is tested in the support-mounted configuration and spacer-mounted configuration is used for a switch with a shortened blade. The tests are conducted on Modified Switch with the grounding blade in closed and open position.

Chapter 8 includes a summary of the key findings and conclusions drawn from the research project.

The IEEE 693-1997 recommended practice for earthquake testing of disconnect switches and new recommendations developed in a companion study (Takhirov, et al, 2004) are summarized in Appendix A. Appendix B presents complete list of all test step undertaken. Resonance search results for two configurations of the switch used for qualification study are presented in Appendix C. Raw data and video images from all earthquake tests are supplied to Pacific Gas & Electric, Southern California Edison, San Diego Gas & Electric, and Southern States Inc. (manufacturer of the switch), under separate cover.

## 2 Testing Procedure for Seismic Qualification

The chapter presents information on the seismic qualification testing procedure used during the study including test setup and instrumentation, switch configurations tested, experimental program, and input strong motion time histories.

### 2.1 SWITCH CONFIGURATIONS AND EXPERIMENTATION SETUP

The 550-kV disconnect switch was tested in three configurations: mounted on typical 14 ft tall supports, mounted on a short 4-in spacers to simulate flexibility of the top plates of the supports, and rigidly attached to the earthquake simulation platform. The switch was tested dynamically on the earthquake simulation platform (shaking table) by means of random, sweep, and IEEE-compatible time histories. Some component testing was conducted before and after the major dynamic testing.

#### 2.1.1 Major Components of Single Pole Switch and Experimentation Setup

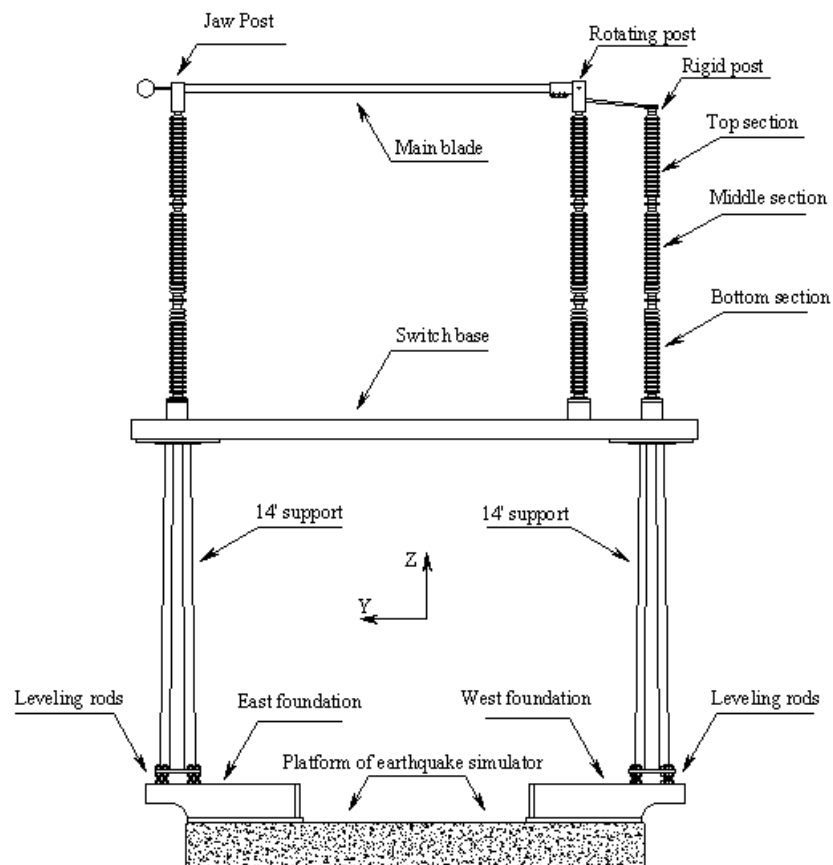
The experimental study uses a single pole type “EV-1” switch with electrical ratings: 550-kV and 4000 A. The switch was manufactured, supplied, and assembled on the earthquake simulation platform by Southern States, Inc. (SS).

The pole was assembled from several major components as shown in Fig. 2.1 that presents a typical field installation: the switch typically installed on tall supports represents an assembly consisting of a base, insulator posts, and a main blade. The insulator posts were assembled on the base of the switch and named Rigid, Rotating, and Jaw. The porcelain insulators used in the study were manufactured and supplied by NGK-Locke, Inc., Catalog #8A-69446A rated at 2900 lbs cantilever strength. Each insulator post consists of three sections: bottom, middle, and top with decreasing cross section from bottom to top. The switch is installed in elevated position on a support structure that consists of two steel tapered legs. The support



columns have tubular sections and they were manufactured and supplied by Valmont Industries, Inc. The leveling of the whole structure in a field installation is typically achieved by the use of leveling nuts on threaded rods embedded in the foundation under the pole. The configuration of the anchor bolts at the column bases is intended to represent the case in which base plates are left ungrouted, which is a frequent utility practice.

In addition to the main blade, the switch tested has a grounding blade located at Jaw post. The grounding switch and the main blade are operated by the motor mechanism mounted on the support under Rigid post as shown in Fig.2.2.



**Fig. 2.1. Major components of single pole switch assembled on earthquake simulation platform.**

### 2.1.2 Switch Configurations Tested in the Study

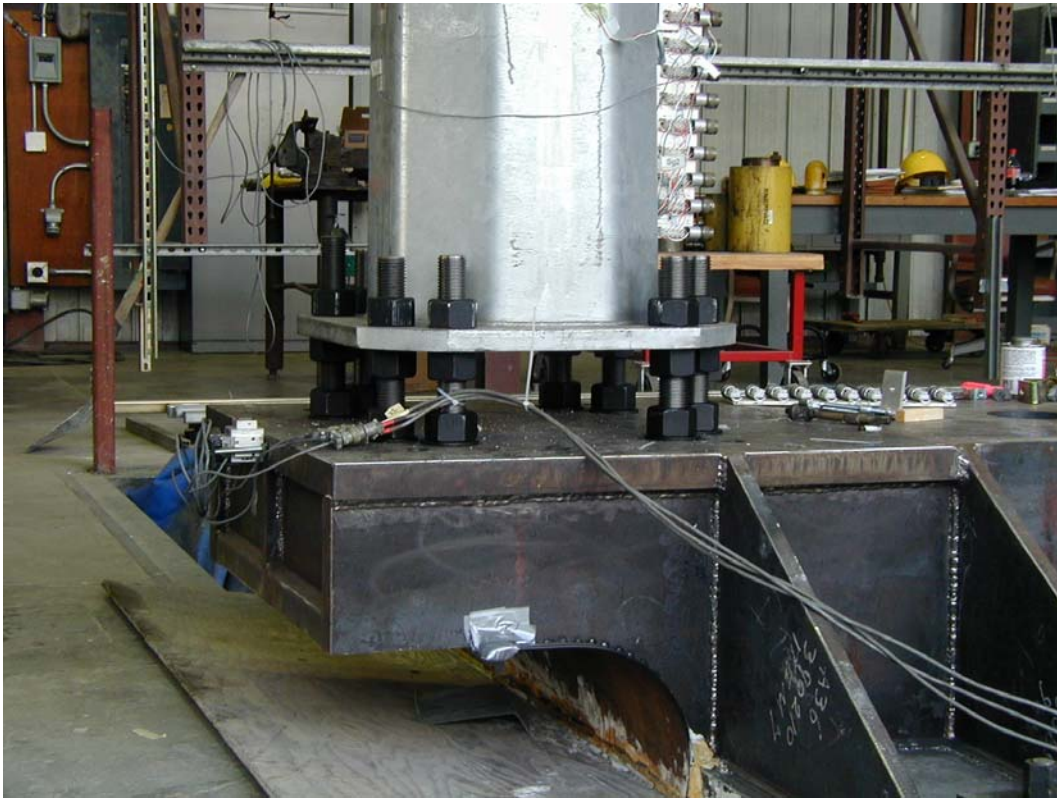
The switch was tested in three configurations, Configuration 1, Configuration 2, and Configuration 3. The footprints of the switch base and support legs exceeded the size of the



**Fig. 2.2. Configuration 1: support-mounted configuration of switch (main blade closed).**

earthquake simulation platform, therefore two relatively rigid foundations were designed and built in order to extend the size of the shaking table and attach the switch to it. Configuration 1

represents a typical field mounting as shown in Fig. 2.2: the switch is mounted on 14 ft tall supports that are attached to the foundations by means of the leveling threaded rods, and the details of the attachment to the foundation are shown in Fig. 2.3. In case of Configuration 2 switch is mounted on short 4-in spacers that are designed to simulate a flexibility of top plates in the 14 ft tall supports. The switch is tested with the main blade open and closed in Configuration 2 as presented in Figs. 2.4 and 2.5. The details of the attachment to the foundations are presented in Fig. 2.6. The switch attached directly to the foundations represents Configuration 3.



**Fig. 2.3. Details of attachment to the rigid foundation for Configuration 1.**

### **2.1.3 Instrumentation**

The 550-kV disconnect switch was extensively instrumented by strain gages, accelerometers, and displacement transducers installed at the most critical locations. The list of the instrumentation used is presented in Table 2.1.

**Table 2.1. Instrumentation list**

| No.  | Quantity     | Device No. | Location/ID                               | Blade Closed | Blade Open |
|--|--------------|------------|---|--------------|------------|
| <b><i>Displacements of table</i></b>                                   |              |            |   |              |            |
| 1  | Displacement |            | Horizontal in N-S direction (SE Actuator) | X            | X          |
| 2  | Displacement |            | Horizontal in E-W direction (NE Actuator) | Y            | Y          |
| 3  | Displacement |            | Horizontal in N-S direction (NW Actuator) | X            | X          |
| 4  | Displacement |            | Horizontal in E-W direction (SW Actuator) | Y            | Y          |
| 5  | Displacement |            | Vertical Displacement (SE Actuator)       | Z            | Z          |
| 6  | Displacement |            | Vertical Displacement (NE Actuator)       | Z            | Z          |
| 7  | Displacement |            | Vertical Displacement (NW Actuator)       | Z            | Z          |
| 8  | Displacement |            | Vertical Displacement (SW Actuator)       | Z            | Z          |
| <b><i>Accelerations of table</i></b>                                   |              |            |   |              |            |
| 9  | Acceleration |            | Horizontal in N-S direction (SE Actuator) | X            | X          |
| 10   | Acceleration |            | Horizontal in E-W direction (NE Actuator) | Y            | Y          |
| 11   | Acceleration |            | Horizontal in N-S direction (NW Actuator) | X            | X          |
| 12   | Acceleration |            | Horizontal in E-W direction (SW Actuator) | Y            | Y          |
| 13   | Acceleration |            | Vertical Acceleration (SE Actuator)       | Z            | Z          |
| 14   | Acceleration |            | Vertical Acceleration (NE Actuator)       | Z            | Z          |
| 15   | Acceleration |            | Vertical Acceleration (NW Actuator)       | Z            | Z          |
| 16   | Acceleration |            | Vertical Acceleration (SW Actuator)       | Z            | Z          |
| <b><i>Accelerations at top of rigid foundation</i></b>                 |              |            |   |              |            |
| 17   | Acceleration | Acc1       | West foundation                           | X            | X          |
| 18   | Acceleration | Acc2       | West foundation                           | -Y           | -Y         |
| 19   | Acceleration | Acc3       | West foundation                           | Z            | Z          |
| 20   | Acceleration | Acc4       | East foundation                           | X            | X          |
| 21   | Acceleration | Acc5       | East foundation                           | -Y           | -Y         |
| 22   | Acceleration | Acc6       | East foundation                           | Z            | Z          |
| <b><i>Displacements at top of 14 ft tall support</i></b>               |              |            |   |              |            |
| 23   | Displacement | Wp1        | West support                              | X            | X          |
| 24   | Displacement | Wp2        | West support                              | Y            | Y          |
| 25   | Displacement | Wp3        | East support                              | X            | X          |
| 26   | Displacement | DCDT1      | East to West support                      | Y            | Y          |
| <b><i>Flexural displacement of rigid foundation</i></b>                |              |            |   |              |            |
| 27   | Displacement | DCDT2      | West foundation                           | Z @ X-       | Z @ X-     |
| 28   | Displacement | DCDT3      | West foundation                           | Z @ X+       | Z @ X+     |
| <b><i>Switch base accelerations (at top of 14 ft tall support)</i></b> |              |            |   |              |            |
| 29   | Acceleration | Acc7       | West support                              | X            | X          |
| 30   | Acceleration | Acc8       | West support                              | -Y           | -Y         |
| 31   | Acceleration | Acc9       | West support                              | Z            | Z          |
| 32   | Acceleration | Acc10      | East support                              | X            | X          |
| 33   | Acceleration | Acc11      | East support                              | -Y           | -Y         |
| 34   | Acceleration | Acc12      | East support                              | Z            | Z          |
| 35   | Acceleration | Acc13      | Pipe under rotating post                  | X            | X          |
| 36   | Acceleration | Acc14      | Pipe under rotating post                  | -Y           | -Y         |
| 37   | Acceleration | Acc15      | Pipe under rotating post                  | Z            | Z          |

**Table 2.1. Instrumentation list (continued)**

| No.  | Quantity     | Device No. | Location/ID                    | Blade Closed | Blade Open |
|--|--------------|------------|--------------------------------|--------------|------------|
| <b><i>Displacements at top of rigid foundation</i></b>       |              |            |                                |              |            |
| 38   | Displacement | Wp4        | East foundation                | X            | X          |
| 39   | Displacement | Wp5        | West foundation                | X            | X          |
| 40   | Displacement | Wp6        | West foundation                | Y            | Y          |
| <b><i>Displacements at base of rotating post</i></b>         |              |            |                                |              |            |
| 41   | Displacement | Wp7        | Pipe under rotating post       | X            | X          |
| 42   | Displacement | Wp8        | Pipe under rotating post       | X            | X          |
| 43   | Displacement | DCDT4      | Pipe under rotating post       | Z @ X+       | Z @ X+     |
| 44   | Displacement | DCDT5      | Pipe under rotating post       | Z @ X-       | Z @ X-     |
| <b><i>Accelerations at top of insulator posts</i></b>        |              |            |                                |              |            |
| 45   | Acceleration | Acc16      | Rigid post                     | X            | X          |
| 46   | Acceleration | Acc17      | Rigid post                     | -Y           | -Y         |
| 47   | Acceleration | Acc18      | Rigid post                     | Z            | Z          |
| 48   | Acceleration | Acc19      | Rotating post                  | X            | X          |
| 49   | Acceleration | Acc20      | Rotating post                  | -Y           | -Y         |
| 50   | Acceleration | Acc21      | Rotating post                  | Z            | Z          |
| 51   | Acceleration | Acc22      | Jaw post                       | X            | X          |
| 52   | Acceleration | Acc23      | Jaw post                       | -Y           | -Y         |
| 53   | Acceleration | Acc24      | Jaw post                       | Z            | Z          |
| <b><i>Displacements at top of insulator posts</i></b>        |              |            |                                |              |            |
| 54   | Displacement | Wp9        | Rigid post                     | X            | X          |
| 55   | Displacement | Wp10       | Rigid post                     | Y            | Y          |
| 56   | Displacement | Wp11       | Rotating post                  | X            | X          |
| 57   |              |            | empty channel                  |              |            |
| 58   | Displacement | Wp12       | Jaw post                       | X            | X          |
| 59   | Displacement | Wp13       | From jaw post to rotating post | Y            | Y          |
| <b><i>Tip of blade accelerations</i></b>                     |              |            |                                |              |            |
| 60   | Acceleration | Acc25      | Tip of blade                   | X            | -Y         |
| 61   | Acceleration | Acc26      | Tip of blade                   | -Y           | Z          |
| 62   | Acceleration | Acc27      | Tip of blade                   | Z            | X          |
| <b><i>Tip of blade accelerations</i></b>                     |              |            |                                |              |            |
| 63-64  |              |            | empty channels                 |              |            |
| <b><i>Strains in support legs (@20" from base plate)</i></b> |              |            |                                |              |            |
| 65   | Strain       | R11        | East support                   | X @Y-        |            |
| 66   | Strain       | R12        | East support                   | @45toZ@Y-    |            |
| 67   | Strain       | R13        | East support                   | Z @Y-        |            |
| 68   | Strain       | R21        | East support                   | Y @X-        |            |
| 69   | Strain       | R22        | East support                   | @45toZ @X-   |            |
| 70   | Strain       | R23        | East support                   | Z @X-        |            |
| 71   | Strain       | Sg3        | East support                   | Z @Y+        |            |
| 72   | Strain       | Sg4        | East support                   | Z @X+        |            |
| 73   | Strain       | Sg5        | West Support                   | Z @Y+        |            |
| 74   | Strain       | R61        | West Support                   | Y @X+        |            |
| 75   | Strain       | R62        | West Support                   | @45toZ@X+    |            |

**Table 2.1. Instrumentation list (continued)**

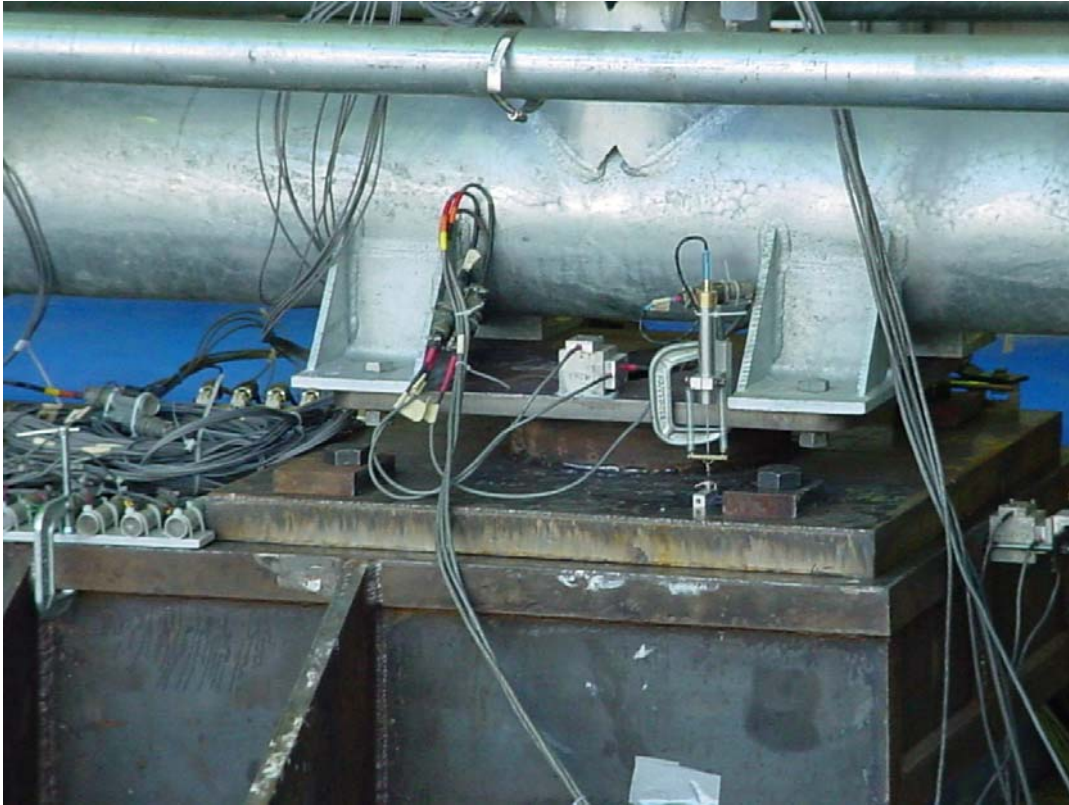
| No.   | Quantity | Device No. | Location\ID              | Blade Closed | Blade Open |
|---|----------|------------|--------------------------|--------------|------------|
| 76  | Strain   | R63        | West Support             | Z @X+        |            |
| 77  | Strain   | R71        | West Support             | X @Y-        |            |
| 78  | Strain   | R72        | West Support             | @45toZ @Y-   |            |
| 79  | Strain   | R73        | West Support             | Z @Y-        |            |
| 80  | Strain   | Sg8        | West Support             | Z @X-        |            |
| <b>Porcelain strains (base of bottom porcelain section)</b> |          |            |                          |              |            |
| 81  | Strain   | Sg9        | Rigid post               | Z @X-        | Z @X-      |
| 82  | Strain   | Sg10       | Rigid post               | Z @Y-        | Z @Y-      |
| 83  | Strain   | Sg11       | Rigid post               | Z @X+        | Z @X+      |
| 84  | Strain   | Sg12       | Rigid post               | Z @Y+        | Z @Y+      |
| 85  | Strain   | Sg13       | Rotating post            | Z @X-        |            |
| 86  | Strain   | Sg14       | Rotating post            | Z @Y-        |            |
| 87  | Strain   | Sg15       | Rotating post            | Z @ X+       |            |
| 88  | Strain   | Sg16       | Rotating post            | Z @Y+        |            |
| 89  | Strain   | Sg17       | Jaw post                 | Z @X-        | Z @X-      |
| 90  | Strain   | Sg18       | Jaw post                 | Z @Y-        | Z @Y-      |
| 91  | Strain   | Sg19       | Jaw post                 | Z @X+        | Z @X+      |
| 92  | Strain   | Sg20       | Jaw post                 | Z @Y+        | Z @Y+      |
| <b>Porcelain strains (base of middle porcelain section)</b> |          |            |                          |              |            |
| 93  | Strain   | Sg21       | Jaw post                 | Z @X-        | Z @X-      |
| 94  | Strain   | Sg22       | Jaw post                 | Z @Y-        | Z @Y-      |
| 95  | Strain   | Sg23       | Jaw post                 | Z @X+        | Z @X+      |
| 96  | Strain   | Sg24       | Jaw post                 | Z @Y+        | Z @Y+      |
| 97  | Strain   | Sg25       | Rigid post               | Z @X-        | Z @X-      |
| 98  | Strain   | Sg26       | Rigid post               | Z @Y+        | Z @Y+      |
| 99  | Strain   | Sg27       | Rigid post               | Z @X+        | Z @X+      |
| 100   | Strain   | Sg28       | Rigid post               | Z @Y-        | Z @Y-      |
| <b>Porcelain strains (base of top porcelain section)</b>    |          |            |                          |              |            |
| 101   | Strain   | Sg29       | Rigid post               | Z @X-        | Z @X-      |
| 102   | Strain   | Sg30       | Rigid post               | Z @Y+        | Z @Y+      |
| 103   | Strain   | Sg31       | Rigid post               | Z @X+        | Z @X+      |
| 104   | Strain   | Sg32       | Rigid post               | Z @Y-        | Z @Y-      |
| <b>Porcelain strains (top of top porcelain unit)</b>        |          |            |                          |              |            |
| 105   | Strain   | Sg33       | Rigid post               | Z @X+        | Z @X+      |
| 106   | Strain   | Sg34       | Rigid post               | Z @Y-        | Z @Y-      |
| <b>Strain at bottom of blade (4.5" from root)</b>           |          |            |                          |              |            |
| 107   | Strain   | Sg35       | Top of blade pipe        | Y @Z+        | Z @X-      |
| 108   | Strain   | Sg36       | North side of blade pipe | Y @X-        | Z @X+      |
| 109   | Strain   | Sg37       | Bottom of blade pipe     | Y @Z-        | Z @Y+      |
| 110   | Strain   | Sg38       | South side of blade pipe | Y @X+        | Z @Y+      |
| <b>Electrical connectivity test (closed switch)</b>         |          |            |                          |              |            |
| 111   | Current  | Voltmeter  |                          |              |            |
| <b>Load cell for static pull-back tests</b>                 |          |            |                          |              |            |
| 112   | Load     | Load cell  |                          |              |            |



**Fig. 2.4. Configuration 2: spacer-mounted configuration of switch (main blade closed).**



**Fig. 2.5. Configuration 2: spacer-mounted configuration of switch (main blade open).**



**Fig. 2.6.** Details of attachment to the foundation for Configuration 2.

**Strain gages.** Strain gages were installed on the most critical parts of the switch. The insulator posts were instrumented by the unidirectional strain gages to measure a bending strain at several levels along height of insulator posts. For redundancy, the strain gages were installed 90 degrees apart along the section's circumference at each level. The details of the strain gages location on the porcelain insulator posts are presented in Fig. 2.7.

The second major component instrumented by the strain gages was a support structure. The gages were installed and placed in 90 degrees increments around the circumference of the support's section. The strain gages consisted of unidirectional strain gages and rosettes to be used for computing the equivalent cantilever loads, bending moments and principal strains in the legs. The blade of the switch was instrumented by the unidirectional strain gages only. Four strain gages were installed near the root of the blade with 90 degrees increment around the blade's circumference. They were used to estimate the cantilever loads and bending moments during the tests. The locations of the strain gages with the dimensions are presented in Fig. 2.8, and a typical strain gage installation on the porcelain insulator is shown in Fig. 2.9. The strain gage installation at the location close to the root of the blade is presented in Fig. 2.10.



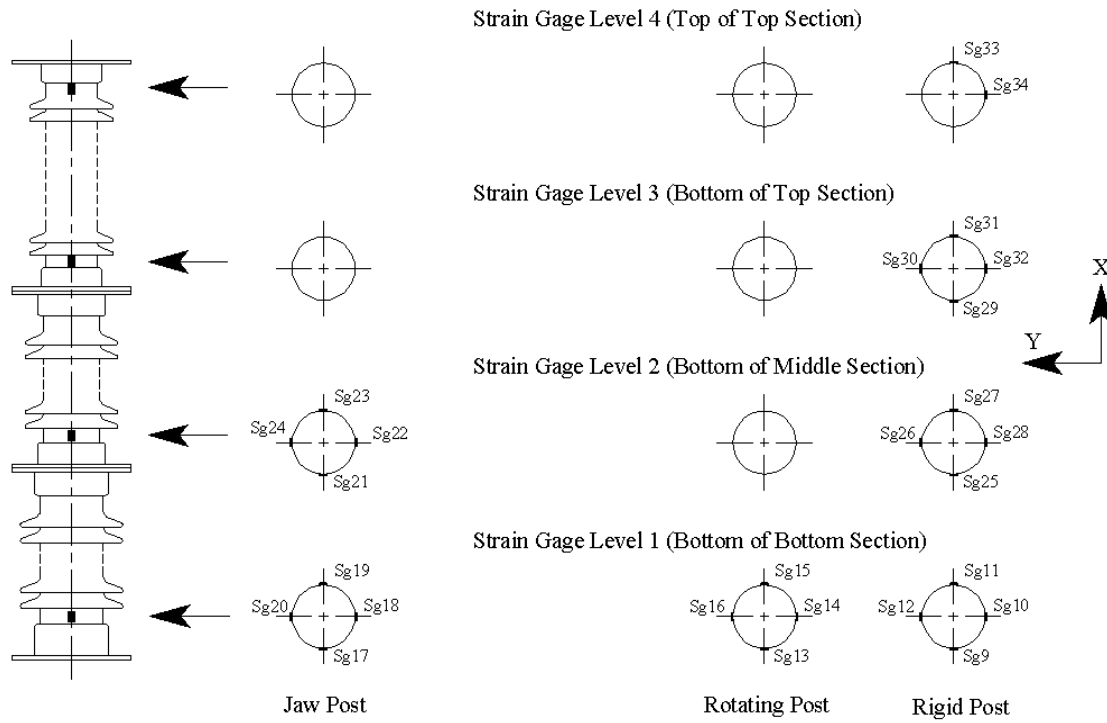


Fig. 2.7. Strain gage locations on insulator posts.

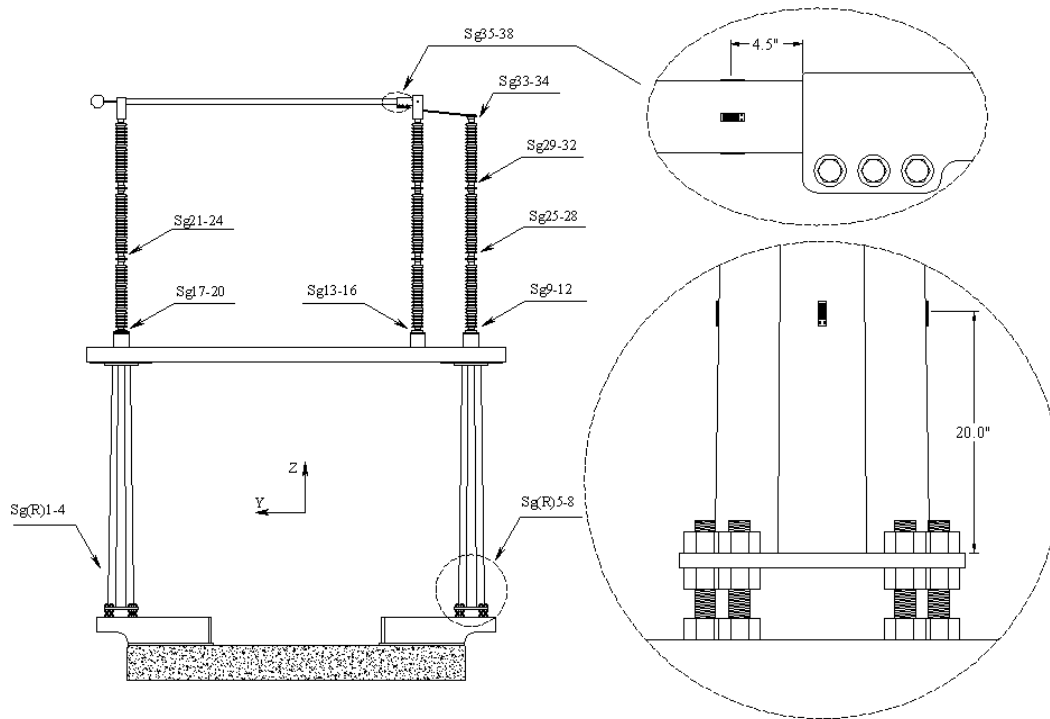


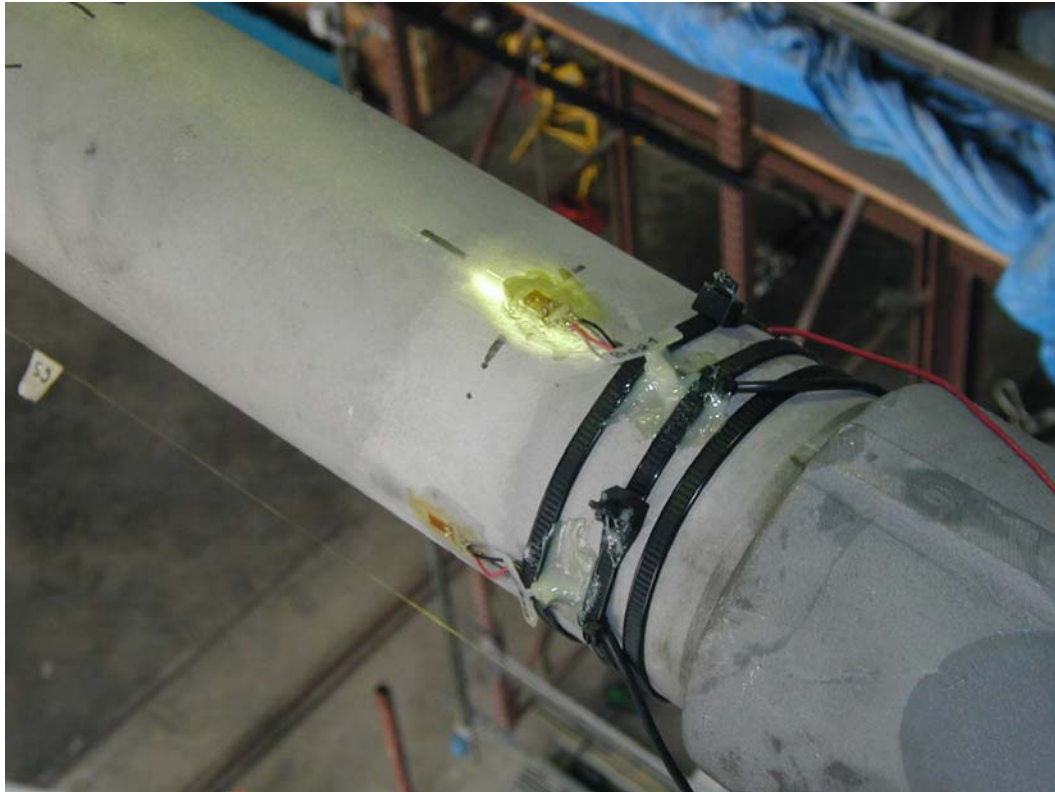
Fig. 2.8. Strain gage locations on steel supports and switch blade.

***Accelerometers.*** The switch was instrumented by accelerometers to record three-component acceleration data at the top of the foundation, top of the support legs, top of the insulator posts, and at the tip of the blade. The accelerometer locations for the switch in two configurations (with and without supports) are shown in Fig. 2.11. A photo of a typical installation of accelerometers is presented in Fig. 2.12 and shows the accelerometers on the top of Rigid post.

***Displacement Transducers.*** Displacement transducers were used to measure horizontal displacements at the major locations. The majority of the transducers measure a horizontal displacement of the switch parts relative to two stiff instrumentation frames located in vicinity of the earthquake simulation platform. In addition, two sets of the displacement transducers were used to measure a vertical displacement of the switch components. One set was installed to measure rotation of the pipe at the base of the switch and the pipe's vertical displacement relative to the platform. A second set confirmed that vertical displacements of the cantilevered part of the stiff foundation were negligible. The drawing for the displacement transducer locations is presented in Fig. 2.13, which shows the support-mounted configuration of the switch. The horizontal displacements were measured at three levels as shown in the figure. For the configuration with no supports, the displacements were recorded at two levels as presented in Fig. 2.14. The displacement at the tip of the blade was estimated from the acceleration data.



**Fig. 2.9.** Sample of typical strain gage installation on insulator post.



**Fig. 2.10.** Strain gage location on switch's blade.

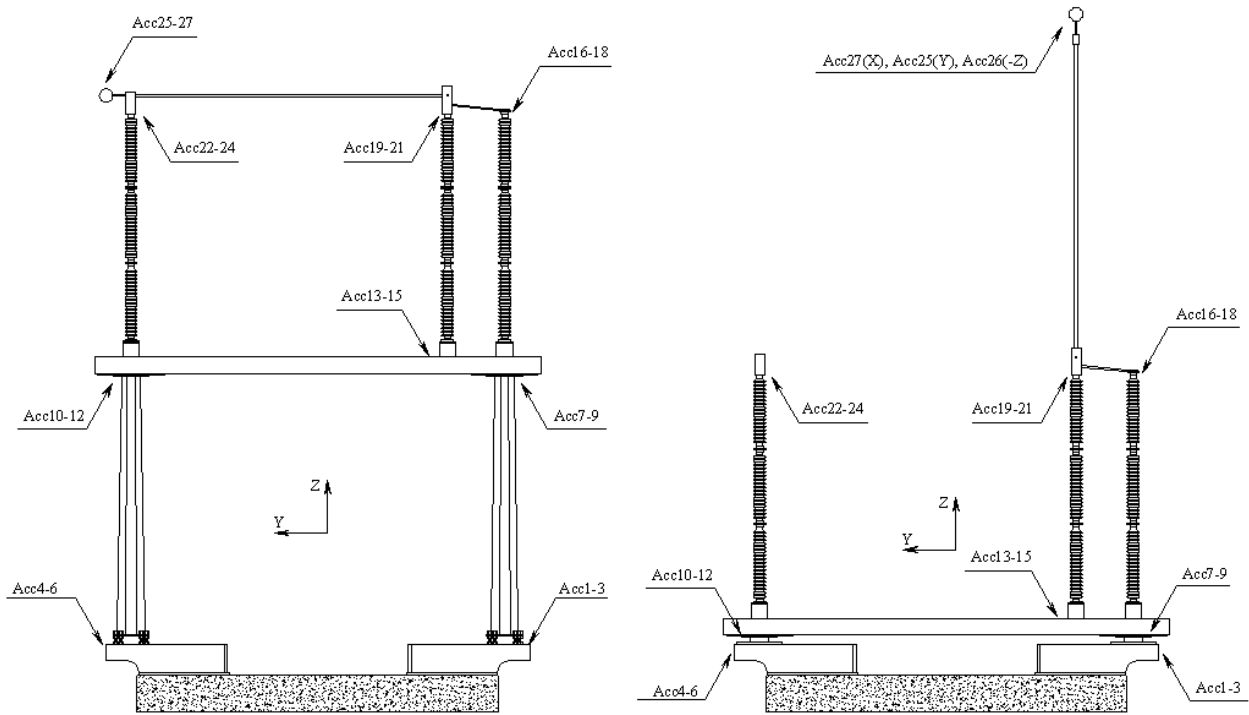


Fig. 2.11. Accelerometer locations for switch in two configurations

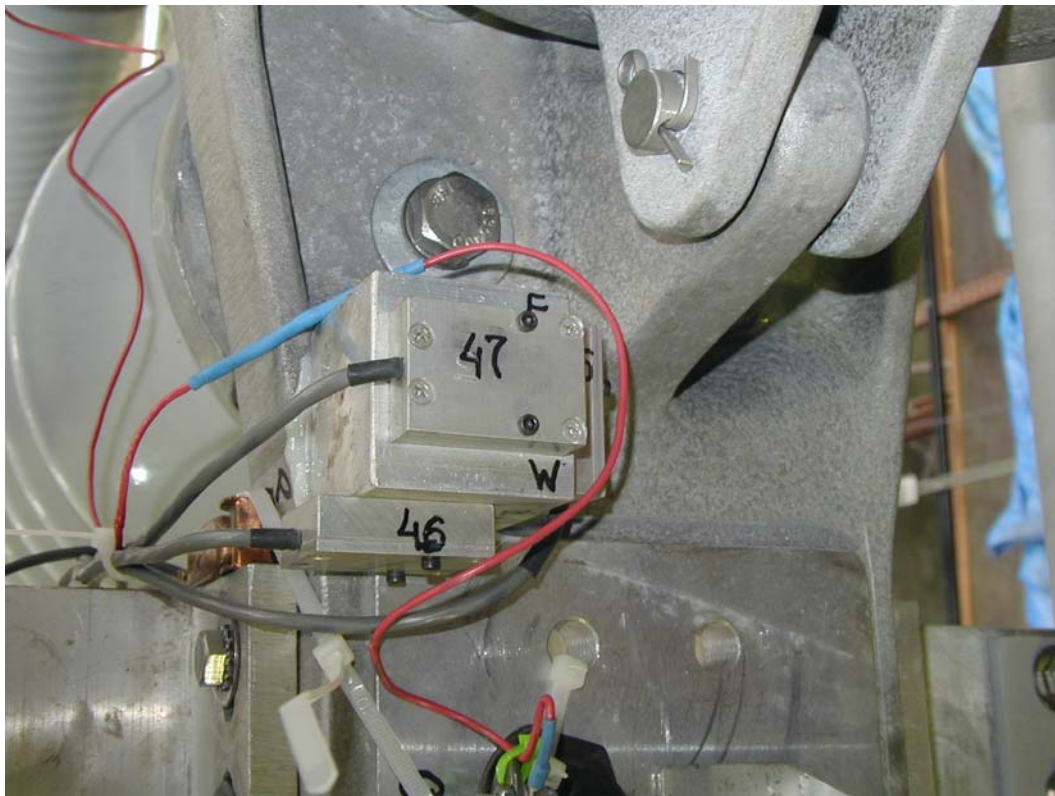


Fig. 2.12. Sample of typical accelerometer installation (top of Rigid Post).

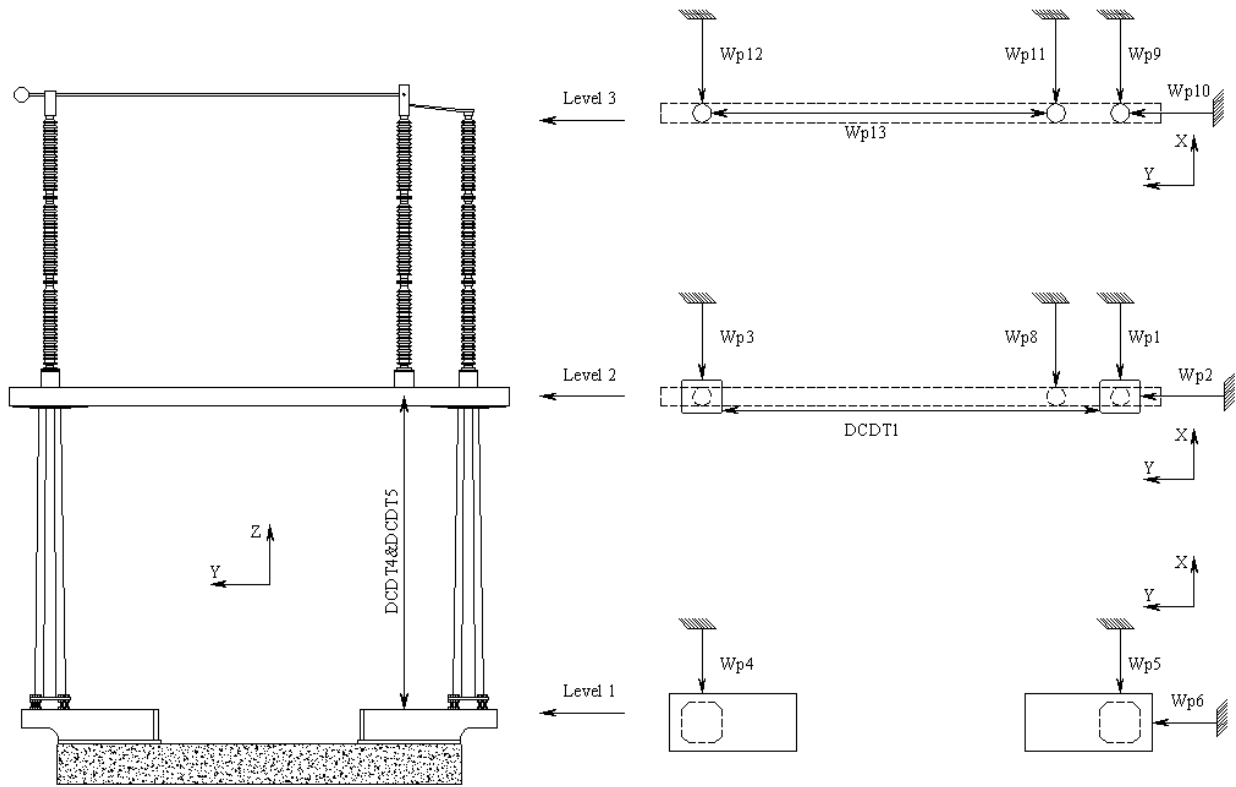


Fig. 2.13. Displacement transducer locations for support mounted configuration.

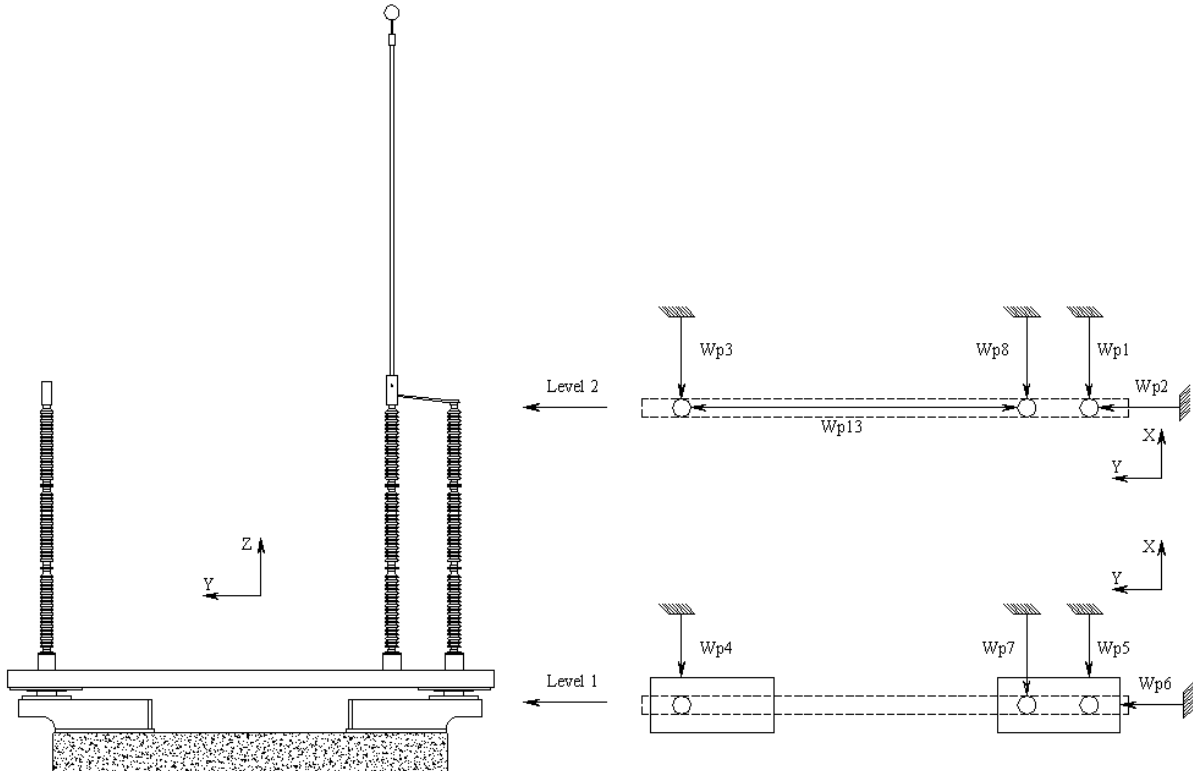


Fig. 2.14. Displacement transducer locations for configuration without support structure.

## 2.2 EXPERIMENTAL PROGRAM

The experimental program included seismic qualification testing of the switch under the IEEE 693 requirements. A second part assessed the feasibility of testing tall electric equipment with components and supports removed or replaced by equivalent ones. The list of tests steps conducted during the experimental study is presented in Appendix B.

### 2.2.1 Qualification Testing

The primary objective of the study is to conduct a seismic qualification test of a 550-kV switch in a typical field installation in accordance with the IEEE 693-1997 (IEEE, 1998) requirements. Due to size limitations of the earthquake simulation platform only a single pole switch could be subjected to the required stages of testing. The IEEE 693 document provides two options for seismic qualification testing at the High Level: the test specimen should be subjected to a strong motion time history with the test response spectrum (TRS) that envelopes the IEEE required response spectra (RRS) at 0.5g pga or the TRS should envelope the IEEE Performance Level (PL) spectrum (twice the RRS) anchored at 1.0g pga. Input motions used in this project are intended to conform to the new recommended requirements for development of input motions summarized in Appendix A. New recommended requirements include various computational checks intended to assure robustness of the input motion, and new matching/ enveloping requirements to supplement the requirements of IEEE 693-1997. It should be noted that the new recommended requirements summarized in Appendix A at present, do not constitute a part of IEEE 693.

In the first option the stresses at the most critical components of the electrical equipment should be less than the allowable stresses and the equipment must remain functional and sustain no structural damage. In the second option, qualified equipment is expected to perform acceptably up to the PL loading, although some minor structural damage may occur.

**Dynamic Testing.** The dynamic testing by means of the earthquake simulation platform involves random noise testing, sine-sweep testing, and testing with the IEEE-compatible strong motion time history. Because of the limited clearance above the earthquake simulation platform, three configurations of the switch were tested for qualification purposes. Configuration 1 was tested up to high seismic Performance Level (PL), whereas the other two were tested to high RRS qualification level. For Configuration 2 and Configuration 3 an amplification factor due the

support structure was introduced, as estimated from the experimental study of Configuration 1. The input strong motion for the earthquake simulation platform was amplified by this factor to represent the effect of the omitted support structure.

The IEEE 693 standard requires conducting a low-level resonance search (e.g., sine sweep or white noise vibration test), prior to the earthquake time history test, for estimating the natural frequencies and the damping values of the equipment. To calibrate the strain gages installed on the switch, the instrumented switch components were statically tested at low levels of loading. The stiffness of the switch configuration was estimated during static pull-back tests, and the natural frequency and damping value for each configuration were also estimated from a free-vibration test. All of these test steps are included in the experimental program presented in Table 2.2 (part 2).

***Experimental Program for Major Components of Switch.*** An experimental study of major components of the switch included tests before and after the seismic qualification tests. The component testing consisted of calibration tests of insulator sections, calibration tests for support legs with and without leveling bolts, and low-level calibration and cantilever strength tests for assembled insulator posts. A free-vibration testing is conducted for the support legs and the insulator posts to estimate their natural frequencies and damping values. The list of experimental steps related to the component testing is also presented in Table 2.2 (part 1).

### **2.2.2 Experimental Study on Feasibility of Testing without Support Structure**

An experimental study on the feasibility of the switch testing without a support structure was one of the most important objectives of the study. A number of tests were conducted to assess the feasibility of the approach. The list of tests under strong motion time history excitation is presented in Table 2.3. Two tests related to this part of the study are included in the list for seismic qualification testing, namely Test 60 and 84 in Table 2.2.

**Table 2.2. Experimental program for seismic qualification testing of 550-kV switch.****Part 1: Static Component Testing**

| No. | Test No. | File Name    | Signal name/Test                         | Component                                   | Date           |
|-----|----------|--------------|--|---|----------------|
| 1   | 1-4      | *            | Static pullback tests in X and Y         | Both 14 ft tall supports                    | 3/25/03        |
| 2   | 5-14     | *            | Static pullback tests in X and Y         | Insulator posts and sections                | 3/31&4/01/2003 |
| 3   | 171-172  | 030523105635 | Free-vibration and static pull-back test | West 14 ft tall Support (no leveling bolts) | 5/23/03        |
| 4   | 173-181  | 030523111547 | Free-vibration and static fragility test | Insulator posts                             | 5/27&5/28/2003 |

**Part 2: Dynamic and Static Tests of Modified Switch**

| No. | Test No.         | File Name    | Signal name/Test                    | Mounting    | Main Blade | Ground Switch | Date           |
|-----|------------------|--------------|-------------------------------------|-------------|------------|---------------|----------------|
| 5   | 51-58            | *            | Free-vibration and resonance search | 4" spacer   | Closed     | Open          | 4/24/03        |
| 6   | 61-66            | *            | Free-vibration and resonance search | 4" spacer   | Open       | Open          | 4/24/03        |
| 7   | 73-74            | *            | Static pullback tests in X and Y    | 14' Support | Closed     | Open          | 5/6/03         |
| 8   | 75-82            | *            | Free-vibration and resonance search | 14' Support | Closed     | Open          | 5/06&5/07/2003 |
| 9   | 60               | 030424161120 | Landers5L@0.25g                     | 4" spacer   | Closed     | Open          | 4/24/03        |
| 10  | 84               | 030507144116 | Landers5L@0.25g                     | 14' Support | Closed     | Open          | 5/7/03         |
| 11  | 119              | 030515102324 | Landers5L@0.125g                    | 14' Support | Closed     | Open          | 5/15/03        |
| 12  | 120              | 030515103702 | Landers5L@0.25g                     | 14' Support | Closed     | Open          | 5/15/03        |
| 13  | 121              | 030515120814 | Landers5L@0.5g                      | 14' Support | Closed     | Open          | 5/15/03        |
| 14  | 122              | 030515124835 | Landers5H@0.75g                     | 14' Support | Closed     | Open          | 5/15/03        |
| 15  | 123              | 030515150039 | Landers5H@1.0g (PL)                 | 14' Support | Closed     | Open          | 5/15/03        |
| 16  | 124-129, 132-133 | *            | Free-vibration and resonance search | 4" spacer   | Closed     | Open          | 5/19/03        |
| 17  | 134-135, 148-153 | *            | Free-vibration and resonance search | 4" spacer   | Open       | Open          | 5/19/03        |
| 18  | 136-147, 158-160 | *            | Free-vibration and resonance search | 4" spacer   | Open       | Closed        | 5/19&5/20/2003 |
| 19  | 161              | 030520123032 | Landers5H@0.5g                      | 4" spacer   | Open       | Closed        | 5/20/03        |
| 20  | 162              | 030520125337 | Landers5H@0.85g                     | 4" spacer   | Open       | Closed        | 5/20/03        |
| 21  | 163              | 030520132259 | Landers5H@1.0g                      | 4" spacer   | Open       | Closed        | 5/20/03        |
| 22  | 164              | 030520141531 | Landers5H@1.17g                     | 4" spacer   | Open       | Closed        | 5/20/03        |
| 23  | 165-170          | *            | Free-vibration and resonance search | 4" spacer   | Open       | Closed        | 5/20/03        |

Notes: (1) Tests 60 and 84 used for amplification factor calculation; (2) tests 171-181 were conducted after the major dynamic tests.



**Table 2.3. List of tests used in amplification factor assessment study.****Part 1: Tests for Modified Switch Rigidly Mounted to Table; main blade closed: 04/15-04/16&04/18/2003**

| Test  | File Name    | Signal name/Test                      | Mounting | Main Blade | Ground Switch |
|-------|--------------|---------------------------------------|----------|------------|---------------|
| 28-29 | *            | Man excitation in X and Y directions  | Rigid    | Closed     | Open          |
| 34-36 | *            | Random in X, Y, Z directions          | Rigid    | Closed     | Open          |
| 37-39 | *            | Sweep24 in X, Y, Z directions         | Rigid    | Closed     | Open          |
| 40    | 030416135700 | Amplified Landers5L@0.25g; scale 1/4  | Rigid    | Closed     | Open          |
| 41    | 030416144312 | Amplified Landers5L@0.25g; full scale | Rigid    | Closed     | Open          |
| 42    | 030416151618 | Amplified Landers5L@0.25g; scale 2    | Rigid    | Closed     | Open          |
| 50    | 030419150732 | Landers5L@0.25g                       | Rigid    | Closed     | Open          |

**Part 2: Tests for Modified Switch Mounted on 4-in Spacer; main blade closed: 04/24 and 05/19/2003**

| Test  | File Name    | Signal name/Test                      | Mounting  | Main Blade | Ground Switch |
|-------|--------------|---------------------------------------|-----------|------------|---------------|
| 53-55 | *            | Random in X, Y, Z directions          | 4" spacer | Closed     | Open          |
| 56-58 | *            | Sweep24 in X, Y, Z directions         | 4" spacer | Closed     | Open          |
| 59    | 030424160518 | Amplified Landers5L@0.25g; full scale | 4" spacer | Closed     | Open          |
| 60    | 030424161120 | Landers5L@0.25g                       | 4" spacer | Closed     | Open          |
| 130   | 030519111046 | Landers5L@0.25g                       | 4" spacer | Closed     | Open          |
| 131   | 030519104714 | Landers5L@0.5g                        | 4" spacer | Closed     | Open          |
| 156   | 030519163549 | Landers5H@0.5g                        | 4" spacer | Closed     | Open          |

**Part 3: Tests for Modified Switch Mounted on 14 ft tall Supports; main blade closed: 05/06-05/08 and 05/15/2003**

| Test  | File Name    | Signal name/Test                       | Mounting    | Main Blade | Ground Switch |
|-------|--------------|--|-------------|------------|---------------|
| 73-74 | *            | Pullback test in X&Y directions@500lbs | 14' Support | Closed     | Open          |
| 75-76 | *            | Man excitation in X&Y directions       | 14' Support | Closed     | Open          |
| 77-79 | *            | Random in X, Y, Z directions           | 14' Support | Closed     | Open          |
| 80-82 | *            | Sweep24 in X, Y, Z directions          | 14' Support | Closed     | Open          |
| 83    | 030507142414 | Landers5L@0.125g                       | 14' Support | Closed     | Open          |
| 84    | 030507144116 | Landers5L@0.25g                        | 14' Support | Closed     | Open          |
| 85    | 030508122001 | Landers5L@0.125g                       | 14' Support | Closed     | Open          |
| 86    | 030508124144 | Landers5L@0.5g                         | 14' Support | Closed     | Open          |
| 119   | 030515102324 | Landers5L@0.125g                       | 14' Support | Closed     | Open          |
| 120   | 030515103702 | Landers5L@0.25g                        | 14' Support | Closed     | Open          |
| 121   | 030515120814 | Landers5L@0.5g                         | 14' Support | Closed     | Open          |

### 2.2.3 Experimental Study on Feasibility of Testing with Blade Removed or Shortened

Table 2.4 presents a list of experimental steps used in the study to assess the feasibility to test the switch with the main blade removed or replaced by an equivalent mass or equivalent shortened blade. The purpose of the program is to develop recommendations for qualification testing procedure of a support-mounted switch with the main blade in open position that cannot be tested on some major US earthquake simulators because of the clearance limitations above the simulator.

**Table 2.4. Tests of modified support-mounted switch; main blade replaced by dummy mass or removed (05/09&05/12/2003).**

| Test No. | File Name    | Signal name\Test                 | Mounting    | Main Blade | Ground Switch |
|----------|--------------|----------------------------------|-------------|------------|---------------|
| 88-91    | *            | Stiffness in X&Y directions      | 14' Support | Dummy mass | Open          |
| 92-97    | *            | Man excitation in X&Y directions | 14' Support | Removed    | Open          |
| 98-100   | *            | Random in X&Y directions         | 14' Support | Removed    | Open          |
| 101-103  | *            | Sweep24 in X&Y directions        | 14' Support | Removed    | Open          |
| 104-106  | *            | Random in X&Y directions         | 14' Support | Removed    | Closed        |
| 107-109  | *            | Sweep24 in X&Y directions        | 14' Support | Removed    | Closed        |
| 110      | 030512124245 | Landers5L@0.125g                 | 14' Support | Removed    | Open          |
| 111      | 030512142536 | Landers5L@0.25g                  | 14' Support | Removed    | Open          |
| 112      | 030512143921 | Landers5L@0.5g                   | 14' Support | Removed    | Open          |
| 113      | 030512151835 | Landers5L@0.125g                 | 14' Support | Removed    | Closed        |
| 114      | 030512152035 | Landers5L@0.25g                  | 14' Support | Removed    | Closed        |
| 115      | 030512152232 | Landers5L@0.5g                   | 14' Support | Removed    | Closed        |

## 2.3 INPUT TIME HISTORIES FOR EARTHQUAKE SIMULATOR

Two types of earthquake-simulator testing are identified in the IEEE 693 (IEEE, 1998) document and required for the seismic qualification of disconnect switches: (1) earthquake ground motions, and (2) resonant frequency search. The earthquake ground motion tests (termed time-history shake table tests in IEEE 693) and resonant frequency search tests are mandatory. Prior to the time-history shake table tests the resonance search was conducted by means of two different input motions imposed in three principal directions, a broad-band white noise time history and a sine-sweep time history.

The three-component IEEE-compatible Landers strong motion time history (Takhirov, et al, 2004) was used as an input signal for the earthquake simulation platform for the qualification testing. The signal was developed in a companion project (PEER/PG&E Lifelines Program, Task 408). The signal is filtered to accommodate the displacement and velocity limits of the shaking table at PEER and consisted of two versions named Landers5L and Landers5H. The first version is for high RRS spectra testing up to 0.5g pga, whereas the second one is for testing at high seismic Performance Level (PL) with the target spectrum anchored at 1.0g pga. A limited number of tests were conducted with a synthetic IEEE-compatible strong motion obtained from the U.S. Army Construction Engineering Research Laboratory (CERL) and a few tests with Landers3 that is delivered from the IEEE-compatible Landers by using slightly different filtering parameters.

### 2.3.1 Resonance Search Tests

Resonance search tests were conducted with the pga at 0.05g in all three principal directions as required by IEEE 693 in section A.1.3 (IEEE, 1998). Sine-sweep and broad-band white noise tests were used to determine the natural frequencies and damping ratios of the switch. Free vibrations tests are used also and are limited to man-excitation and release tests only.

**Broad-band White Noise.** The history for the broad-banded white-noise tests was prepared using a random signal generator that has been commonly used in qualification testing of electrical equipment (Gilani, et al, 1998; Gilani, et al, 1999; Gilani, et al, 2000).

**Sine-sweep.** For the sine-sweep test IEEE 693 specifies that the resonant search should be conducted at a rate not exceeding one octave per minute in the range for which the equipment has resonant frequencies but at least at 1 Hz; frequency searching above 33 Hz is not required. Modal damping was calculated using the half-power bandwidth method. The history for the sine-sweep test was developed using a rate of two octaves per minute (the excitation frequency doubles every 30 seconds). A continuous frequency function of the form

$$f(t) = 2^{t/30} \quad (2.1)$$

where  $t$  is time in seconds, was used to develop the sine-sweep function

$$x(t) = x_0 \sin(2\pi (30/\log 2) 2^{t/30}) \quad (2.2)$$

where  $x$  is the displacement, and  $x_0$  is the maximum displacement.

**Free Vibration Tests.** In addition to the two tests techniques used to assess natural frequency and critical damping of the switch in various configurations and its components, free vibrations tests were also added into the test program. The simplicity of the tests and the reliable data reduction procedure associated with it are two main reasons for inclusion the tests in the test program. Due to adequate flexibility of the switch a man excitation was enough to bring the switch into a decaying cyclic motion. The natural frequency of the switch or its components was estimated by the power spectral density analysis, whereas a critical damping was determined by decay method for free vibration tests (see for instance, Chopra, 1995).

### 2.3.2 Time History Shake Table Tests

Two filtered versions of the IEEE-compatible Landers records developed in the companion project (Takhirov, et al, 2004) were used for the time history tests. The strong motion input signals for the earthquake simulator are represented by three-component time histories with vertical direction at 80% of that for two horizontal directions.

**High IEEE RRS Level (Landers5L).** The earthquake simulator at PEER, University of California, Berkeley is limited to  $-5$  in. to  $+5$  in. horizontally and from  $-2$  in. to  $+2$  in. vertically with velocity up to 30 in/sec. The IEEE-compatible Landers was filtered to accommodate these limitations up to 0.5g pga. The elastic response spectra for this input signal in  $1/12^{\text{th}}$  octave frequency resolution are presented in Fig. 2.15. For a table pga less than 0.5g the three-component strong motion was scaled down by a factor in all three principal directions.

The number of high cycles in SDOF system response with 2% damping is presented in Fig. 2.16. The number of high cycles does not fall below 1 cycle at any frequency of the SDOF system and the plot has less than 5 isolated valleys to 1 cycle count as recommended in the companion study (Takhirov, et al., 2004) and rephrased in Appendix A.

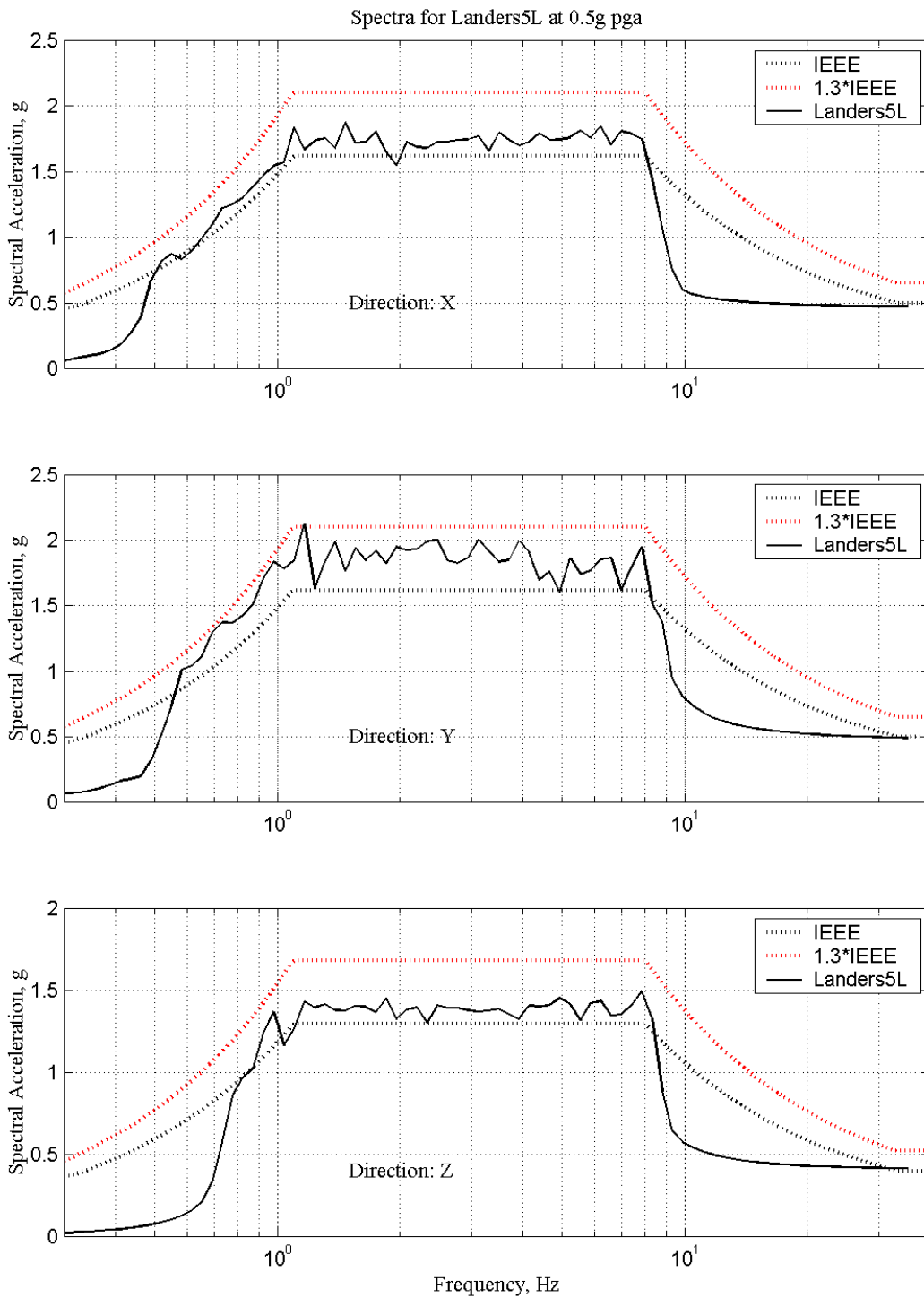
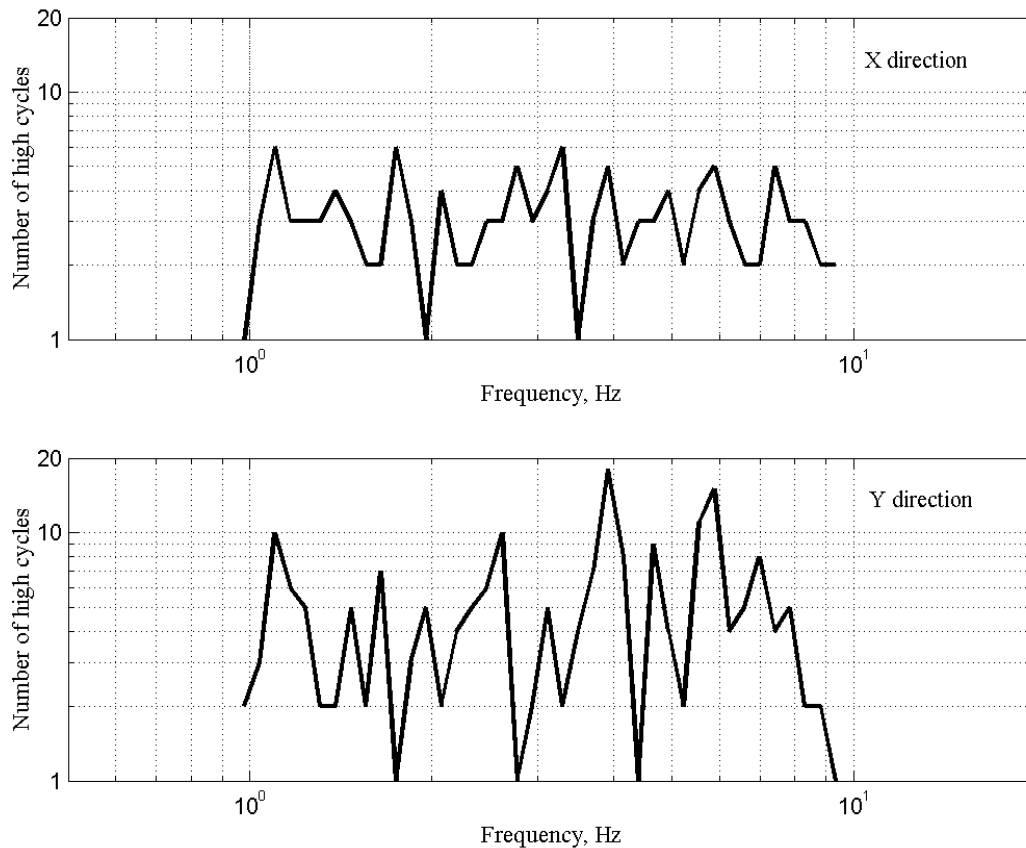


Fig. 2.15. Spectra for Landers5L designed for high RRS test at 0.5g pga.



**Fig. 2.16. High cycle count in SDOF system response for Landers5L anchored at 0.5g pga.**

**High IEEE Performance Level (Landers5H).** Landers5H is intended for a seismic qualification testing at the high Performance Level, therefore it is designed to accommodate the simulator's capacity at 1.0g pga. The elastic response spectra for this input signal in 1/12<sup>th</sup> octave frequency resolution are presented in Fig. 2.17. The number of high cycles in SDOF system response with 2% damping is presented in Fig. 2.18. Similar to the Landers5L, the number of high cycles does not fall below 1 cycle at any frequency of the SDOF system and the plot has less than 5 isolated valleys to 1 cycle count as recommended.

Both the Landers5L and Landers5H substantially satisfy the requirements for input motion developed in the companion theoretical study (Takhirov, et al, 2004) and rephrased in Appendix A.

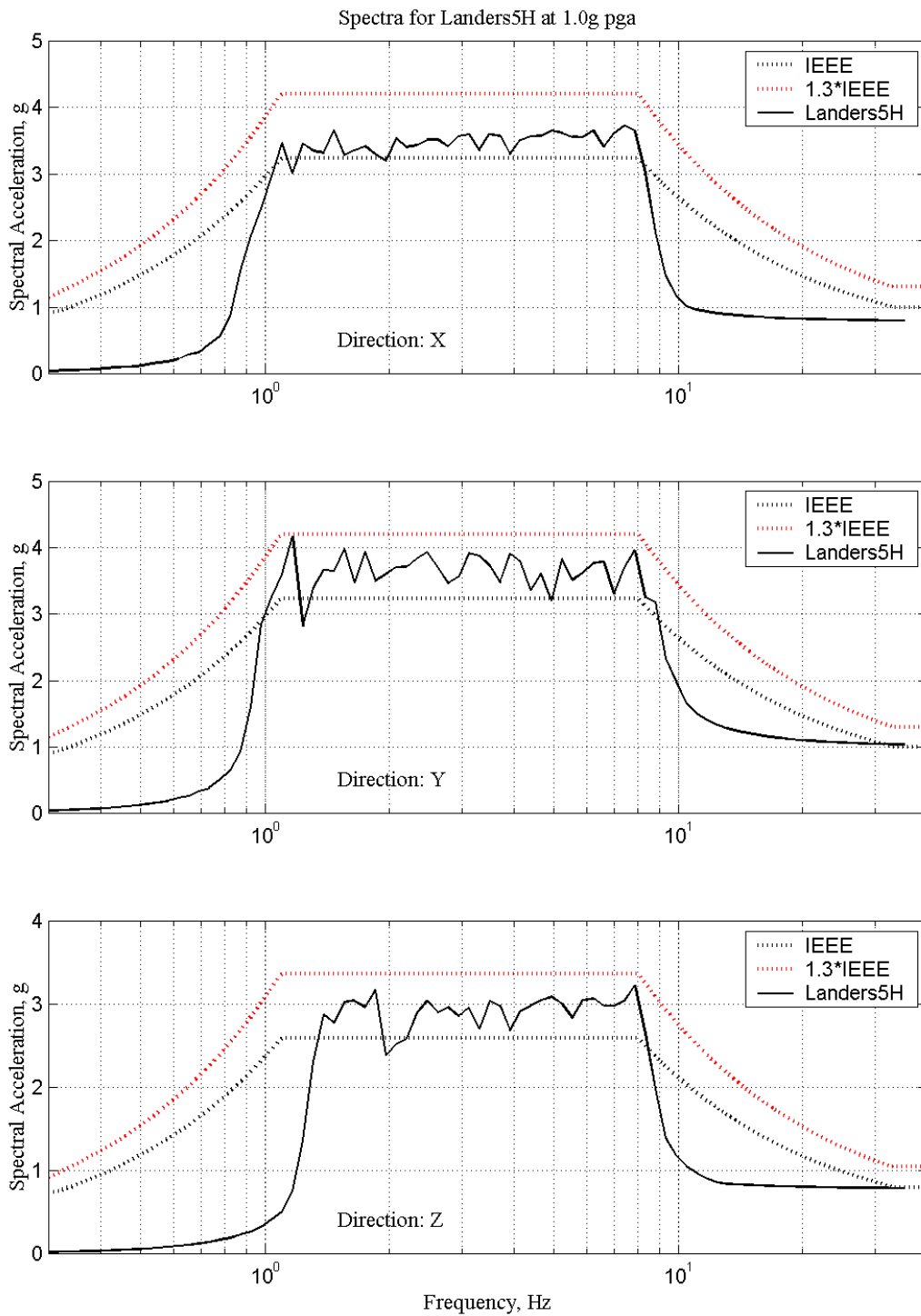
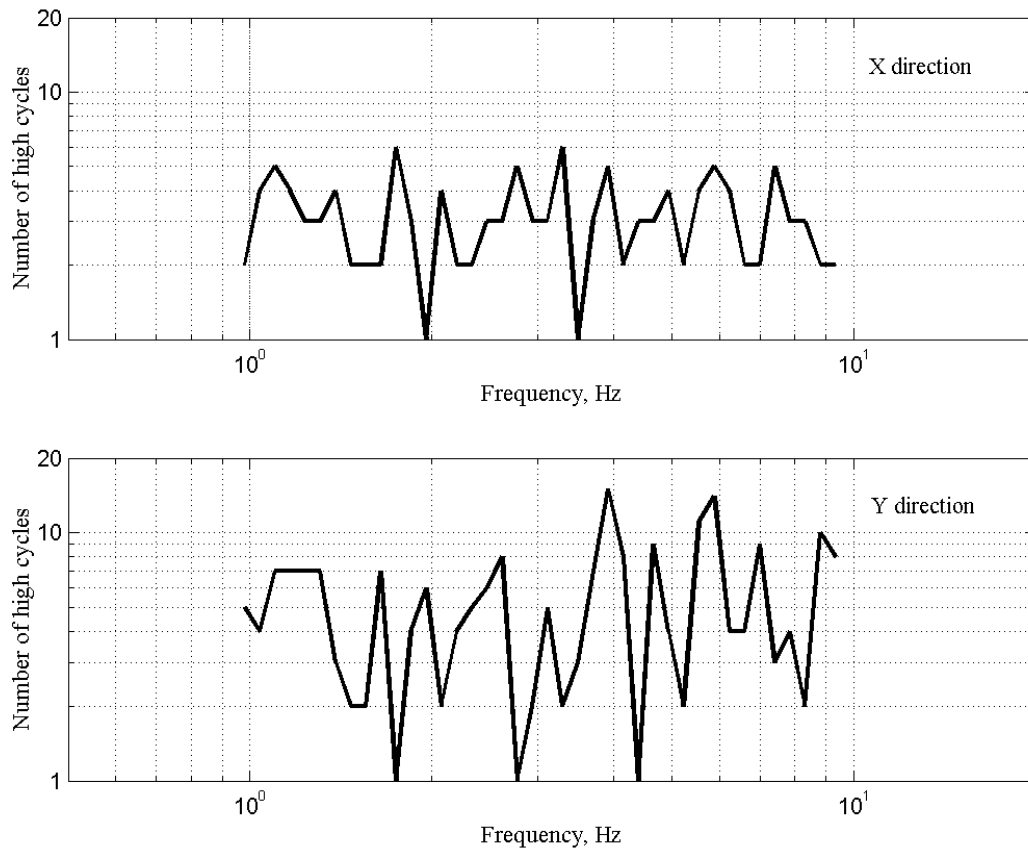


Fig. 2.17. Spectra for Landers5H developed for high PL test at 1.0g pga.



**Fig. 2.18. High cycle count in SDOF system response for Landers5H anchored at 1.0g pga.**



## 3 Disconnect Switch Component Testing

Experimental tests were conducted on components of the switch prior to and after the seismic qualification tests. The typical 14 ft tall supports were tested with and without leveling rods, and the elastic stiffness of the support from a static pull-back test and a natural frequency and a damping from a free-vibration test were estimated. A similar procedure was followed for the insulator posts. The component-testing program concluded with static cantilever strength tests of all insulator posts used in the switch assembly during the qualification tests. The typical test setup for tests of the support and the insulator post is shown in Figs. 3.1 and 3.2.

### 3.1 STATIC AND FREE VIBRATION TESTS FOR 14 FT TALL SUPPORTS

#### 3.1.1 Stiffness Test for Support with Leveling Rods

The main objective of the support testing is to calibrate the strain gages, to calculate stiffness of the support, and to estimate dynamic characteristics of the supports with and without leveling rods.

*Test Setup.* The 14 ft tall supports were attached to two very stiff platforms extending the size of the shaking table. The attachment simulates a common field installation that simplifies leveling procedure with 1 ¾ x 13 in A193 B7 threaded rods (8 per each support) and washers and nuts holding the support in elevated position as shown in Fig. 2.3. This arrangement simulates the common utility practice of leaving column base plates ungrouted, which introduce additional flexibility at the column base. A load was applied horizontally to reproduce a cantilever loading. The monitoring instrumentation is limited to a load cell that records a horizontal load, a displacement transducer that measures a tip displacement of the support, and strain gages that

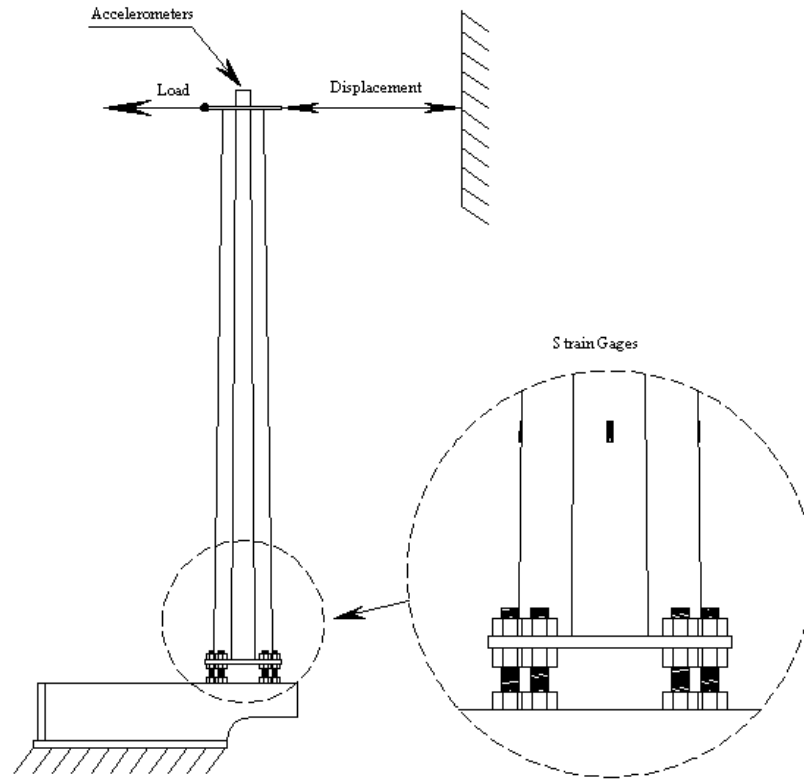


Fig. 3.1. Experimental setup for 14 ft tall support testing.

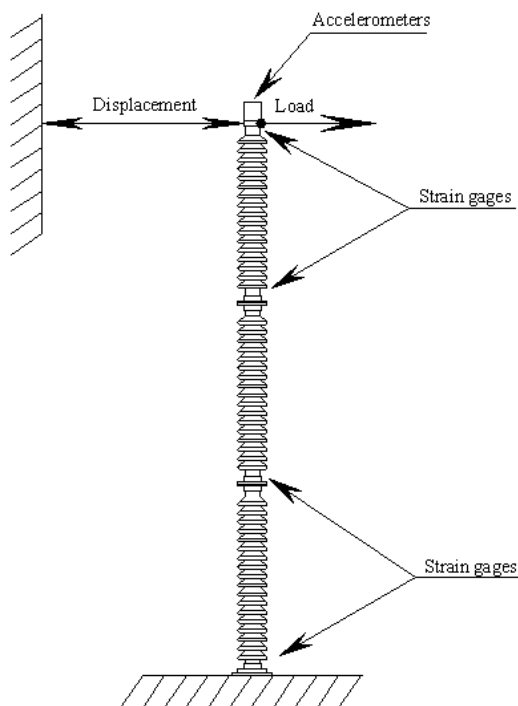


Fig. 3.2. Test setup for insulator post testing: drawing (left) and test in progress (right).

record deformations of the support. The test setup for the experimental study of the support is shown in Fig. 3.1. The horizontal load is limited to 300 lbs to remain within elastic range of deformation in the supports.

**Test Results.** Test results for 14 ft tall supports attached to the foundation by leveling rods are presented in Table 3.1. The average stiffness for both supports and two horizontal directions is estimated as 4.55 kips/in.

**Table 3.1. Stiffness test for supports mounted on leveling rods.**

| No. | File Name    | Support | Signal name                 | Direction | Stiffness, kips/in |
|-----|--------------|---------|-----------------------------|-----------|--------------------|
| 1   | 030325092908 | West    | Pullback test up to 300 lbs | Y         | 4.44               |
| 2   | 030325111853 | West    | Pullback test up to 300 lbs | X         | 4.70               |
| 3   | 030325140725 | East    | Pullback test up to 300 lbs | Y         | 4.61               |
| 4   | 030325142832 | East    | Pullback test up to 300 lbs | X         | 4.44               |

### 3.1.2 Stiffness Test and Free-Vibration for Support without Leveling Rods

The elastic stiffness of the support with no leveling rods (i.e., column base plate bolted directly to foundation blocks) was estimated after accomplishing the seismic qualification testing of the switch assembly. The strains in the steel supports monitored during the highest level dynamic tests of the switch reveal the fact that the plastic deformation had not occurred in the supports. Therefore, the comparison of tests between two mounting configurations of the support (with and without leveling rods) is valid. The test setup is similar to that conducted prior to the dynamic testing except the leveling rods were removed and the support was attached directly to the support platform.

Testing was conducted only for one support (installed on the west side in the switch assembly under the Rigid Post) and only in the X direction. The 14 ft tall support is attached to the essentially rigid foundation extending the size of the shaking table. The test results for both static and free vibration tests are presented in Table 3.2. The average cantilever stiffness of the support with no leveling rods is greater than that with leveling rods at 5.55 kips/in. The frequency and critical damping are consistent for two free vibration tests and are estimated as 15.4 Hz and 0.5%, respectively.

The stiffness of the support with leveling rods is less than that without the rods, as expected, by about 20% and the resonant frequency is about 90% of that of the installation without leveling rods.

**Table 3.2. Stiffness test for supports mounted with no leveling rods.**

| No. | File Name    | Support | Testing                 | Stiffness, kips/in | Frequency, Hz | Damping, % |
|-----|--------------|---------|-------------------------|--------------------|---------------|------------|
| 1   | 030523105635 | West    | Pullback test @ 300 lbs | 5.50               |               |            |
| 2   | 030523105951 | West    | Pullback test @ 300 lbs | 5.60               |               |            |
| 3   | 030523111547 | West    | Free vibration          |                    | 15.4          | 0.5        |
| 4   | 030325141605 | West    | Free vibration          |                    | 15.4          | 0.5        |

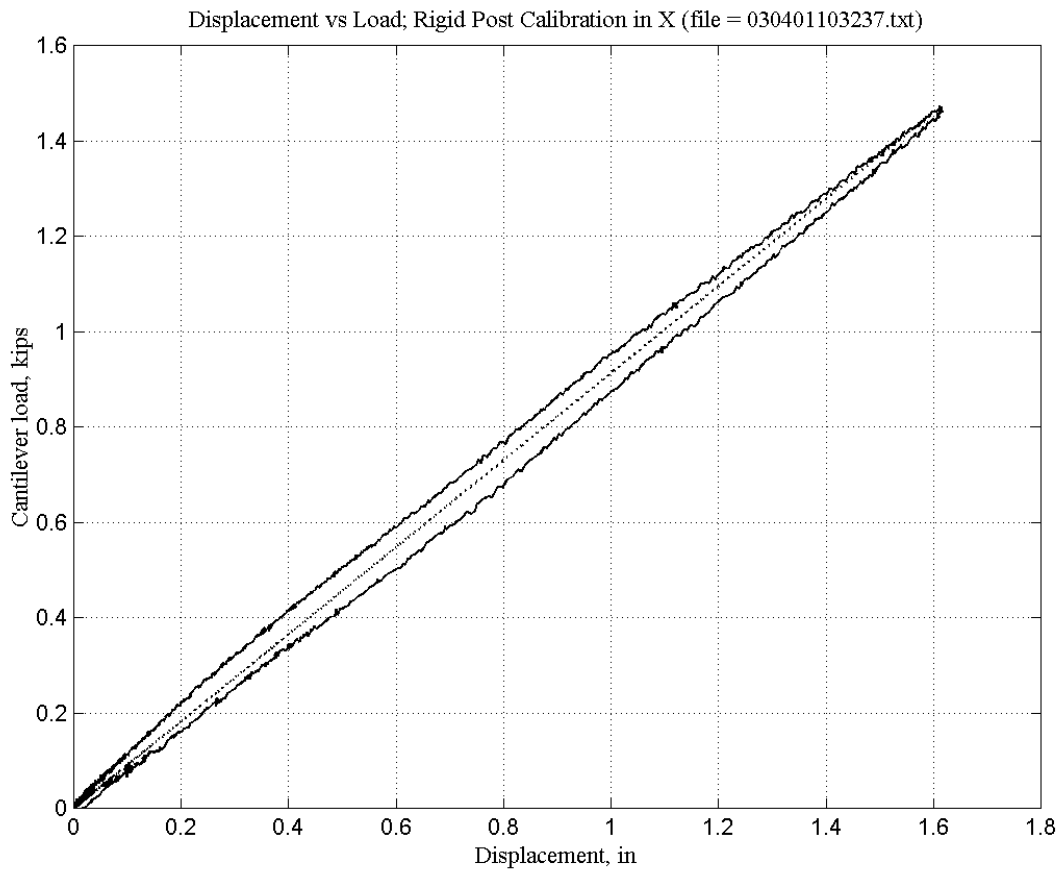
### 3.2 STATIC AND FREE VIBRATION TESTS FOR INSULATORS

#### 3.2.1 Calibration and Stiffness Tests for Porcelain Sections and Assembled Posts

Low-level calibration and stiffness tests for porcelain sections and completely assembled posts were conducted prior to the dynamic testing of the switch. The cantilever tests for insulator posts are very important because they are used for rating an insulator's structural strength. The insulator posts were manufactured and supplied by NGK-Locke, Inc., and consisted of three ceramic sections per each post. The fully assembled posts are rated at 2900 lbs of cantilever load. The cantilever strength rating is a very conservative representation of the breaking strength of the insulator.

**Test Setup.** A separate experimental setup was designed to conduct low-level tests on insulator sections and assembled posts. The test setup is intended to measure a cantilever stiffness of the sections and the posts and calibrate all strain gages installed at multiple locations throughout the insulator sections. The test setup is presented in Fig. 3.2.

**Experimental Results for Sections and Assembled Posts.** The horizontal load versus horizontal deflection diagram for all insulator post is quite close to linear as shown in Fig. 3.3. The stiffness of the various posts for all directions of testing is consistent with some minor variation from the mean of 9.26 kips/in as presented in Table 3.3. Free vibration test reveals the estimation for a natural frequency of posts that is around 8.3 Hz. The low-level static tests conducted for all instrumented sections show consistent gage calibration.



**Fig. 3.3. Typical load-deflection diagram for low-level calibration test (Rigid Post in X direction).**

An interesting phenomenon is observed for the strains in the insulator sections and posts. Since the gages are installed at 90 degrees apart, some gages are in tension and others (180 degrees apart) are in compression during cantilever testing. The horizontal load versus strain relationship is very close to linear, but the slope of the plots is different for positive (compression) and negative (tension) strain. This observation is consistent for all tests on insulator sections and assembled posts. Typical plots for horizontal load versus strain diagrams at three levels of Rigid Post are presented in Fig. 3.4. A similar difference in slopes of load vs. strain for tension and compression was noticed during dynamic tests also as shown in Fig. 3.5. The relation between the compression and tension strains does not follow a dashed line that represents a case when tension strain would be equal to compression strain with opposite sign.

**Table 3.3. Summary for low-level calibration and stiffness tests for insulator posts.**

| No. | File/Direction | Post     | Section | SlopeT, lbs/MS | SlopeC, lbs/MS | Load, kips | Stiffness, kips/in |
|-----|----------------|----------|---------|----------------|----------------|------------|--------------------|
| 1   | 030401103237/X | Rigid    | Bottom  | 4.12           | 3.54           | 1.47       | 0.91               |
|     |                |          | Middle  | 4.21           | 3.67           |            |                    |
|     |                |          | Top     | 3.92           | 3.39           |            |                    |
| 2   | 030401112117/Y | Rigid    | Bottom  | 3.88           | 3.36           | 1.45       | 0.94               |
|     |                |          | Middle  | 4.41           | NA             |            |                    |
|     |                |          | Top     | 3.90           | 3.46           |            |                    |
| 3   | 030331121137/X | Rotating | Bottom  | 3.92           | 3.52           | 1.49       | 0.89               |
| 4   | 030331114650/Y | Rotating | Bottom  | 3.99           | 3.38           | 1.45       | 0.97               |
| 5   | 030401140151/X | Jaw      | Bottom  | 4.15           | 3.47           | 1.45       | 0.98               |
|     |                |          | Middle  | 4.12           | 3.87           |            |                    |
| 6   | 030331114650/Y | Jaw      | Bottom  | 4.18           | 3.54           | 1.44       | 0.93               |
|     |                |          | Middle  | 4.56           | 3.84           |            |                    |

The summary of the calibration tests is presented in Table 3.3, which shows the difference in the slope of negative (Slope T) and positive strains (Slope C). The difference in the slope value varies from about 7% to 20% depending on a particular level of the post. Average slope in tension is estimated as 4.37 lbs/MS (MS stands for micro strain) whereas the mean of slope in compression is estimated as 3.69 lbs/MS; therefore, the difference between two slope means is about 20%. This difference in strain reading may be due to difference in displacement of the bolted joints in tension compared to compression. The tension side of a bolted joint is expected to displace more than the compression side, which results in reduction of the tensile strain, hence a higher calculated slope. Difference in behavior of the grouted joint, or effects related to nonuniformity of the cross-section (e.g., end effects) may also be involved.

It worthy to note that values of load-strain slopes for strain gages installed at the bottom sections are extensively used during the qualification testing in estimation of equivalent cantilever load; therefore, it is important to conduct the strain gage calibration test prior to qualification test.

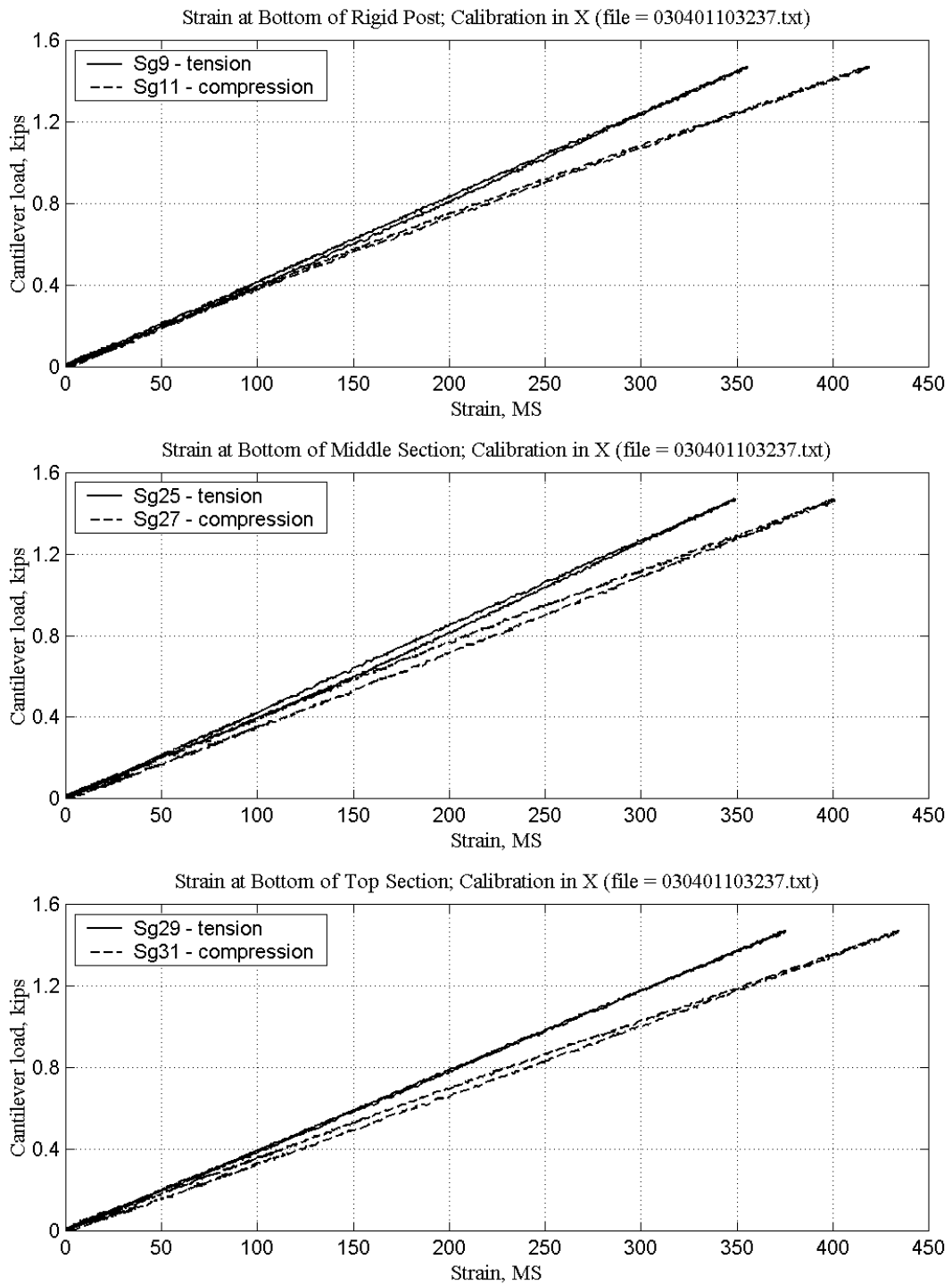
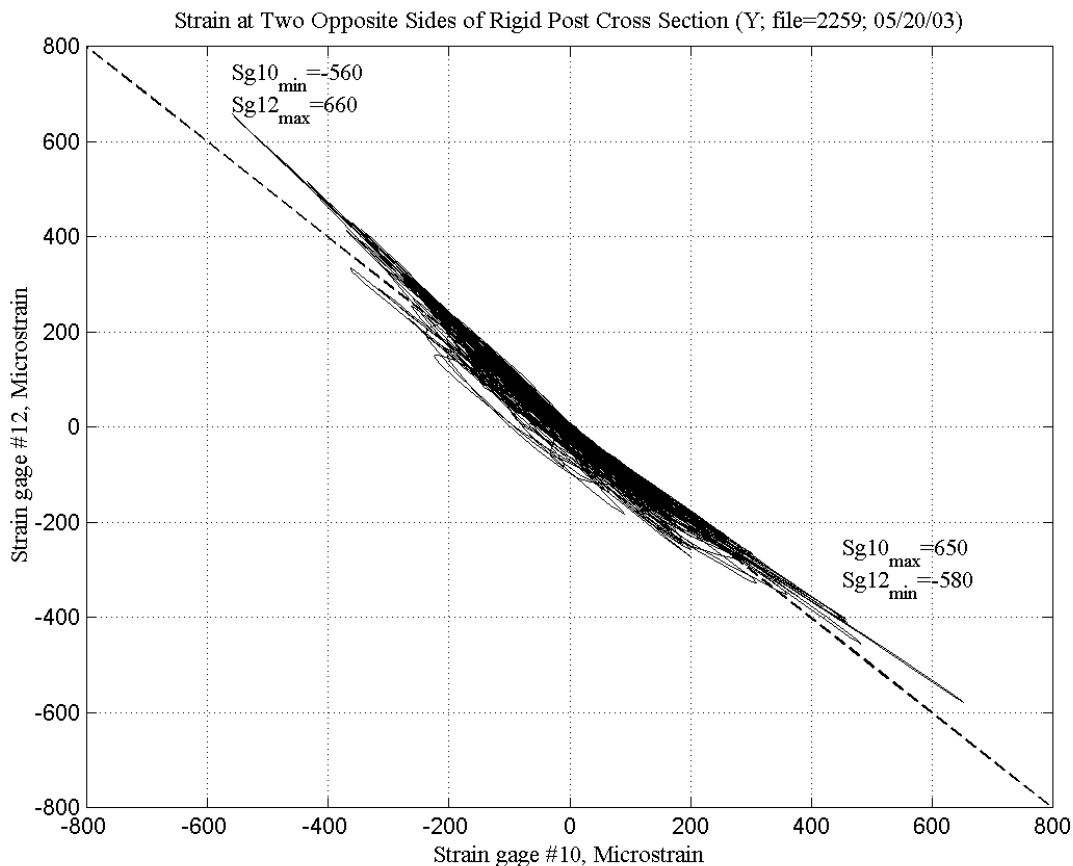


Fig. 3.4. Typical load-strain diagrams for low-level calibration test (Rigid Post in X axis).

### 3.2.2 Static Cantilever Strength Tests for Insulator Posts

The static cantilever strength tests for the insulator posts were conducted after the completion of all dynamic testing of the switch. The test setup is similar to that used for calibration testing and testing procedure follows the requirements of IEC 60168 standard (IEC, 2001). The horizontal load was slowly applied at the tip of the vertically mounted post until failure. All three posts were tested up to the failure. Prior to cantilever strength tests, the posts are tested in free vibration tests in order to estimate a natural frequency and a critical damping. The summary for static cantilever strength tests is presented in Table 3.4.



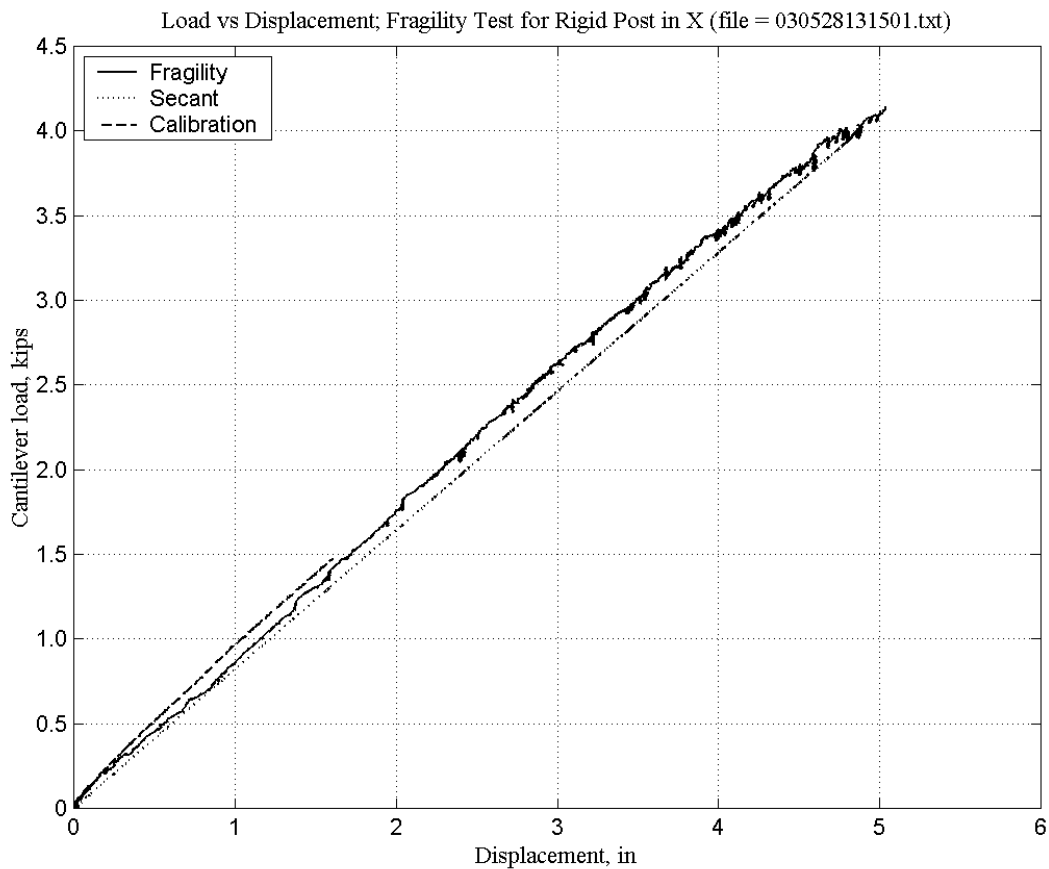
**Fig. 3.5** Strain at two opposite sides of Rigid Post's cross section in Y direction during dynamic testing (dashed line shows a case when tension strain would be equal to compression strain with opposite sign).

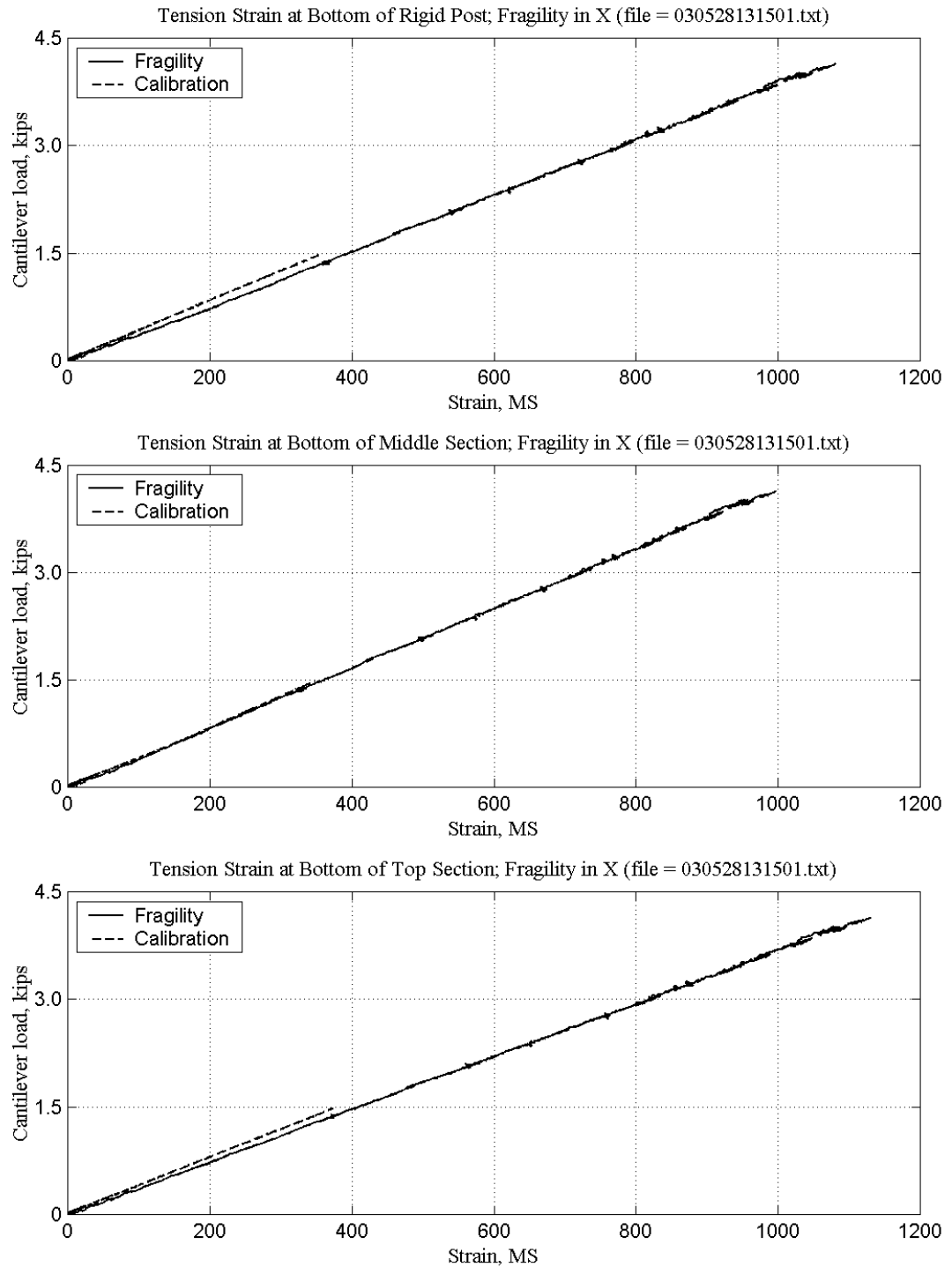


**Table 3.4. Summary of static cantilever strength tests for insulator posts.**

| No. | File/Direction | Post     | Section | SlopeT, lbs/MS | SlopeC, lbs/MS | Load, kips | Stiffness, kips/in |
|-----|----------------|----------|---------|----------------|----------------|------------|--------------------|
| 1   | 030528131501/X | Rigid    | Bottom  | 3.84           | 3.21           | 4.14       | 0.82               |
|     |                |          | Middle  | 4.16           | 3.41           |            |                    |
|     |                |          | Top     | 3.67           | 3.28           |            |                    |
| 3   | 030527152716/X | Rotating | Bottom  | 3.74           | 3.09           | 3.96       | 0.83               |
| 5   | 030528152311/X | Jaw      | Bottom  | 3.93           | 3.37           | 4.31       | 0.85               |
|     |                |          | Middle  | 4.19           | 3.57           |            |                    |

**Rigid Post.** The horizontal load versus deflection diagram for the Rigid Post is presented in Fig. 3.6. The calibration and cantilever strength diagrams are quite close to each other although the peak-to-peak stiffness in strength tests is about 10% less than that during the calibration test. The load-strain plots are also close to each other at low levels of loading as

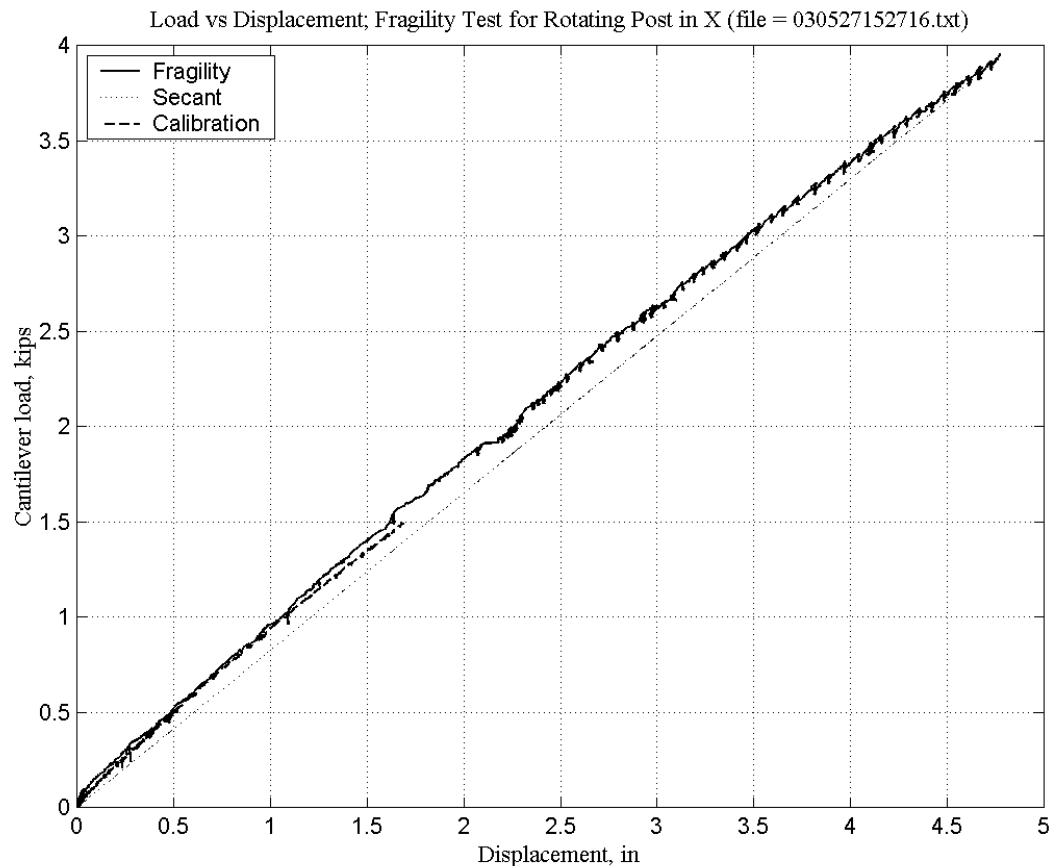
**Fig. 3.6. Load-deflection diagram for static cantilever strength test (Rigid Post in X).**



**Fig. 3.7. Load-tension strain diagram for static cantilever strength test (Rigid Post in X direction).**

shown in Fig. 3.7. Insignificant change (within 10%) in the slope for the load-strain diagram is observed. This small difference may be the result of slight damage, loosening of bolted or grouted joints, or measurement errors. The small changes in the stiffness and the load-strain slope lead to the following conclusions: (1) the material properties of insulator post are close to linear up to its failure and (2) the large amplitude dynamic tests did not affect significantly the material properties of the insulators. The Rigid Post failed at 4,140 lbs cantilever load.

**Rotating Post.** Figure 3.8 shows horizontal load versus tip deflection diagram for the Rotating Post. The test results are similar to that for Rigid Post with close correlation between the calibration and fragility diagrams as for load-deflection and for load-strain diagrams (Fig. 3.9). The Rotating Post failed at 3,960 lbs cantilever load.



**Fig. 3.8.** Load-deflection diagram for static cantilever strength test (Rotating Post in X).

**Jaw Post.** Similar results are obtained for Jaw Post as shown in Fig. 3.10 and Fig. 3.11. The stiffness is slightly less than in the cantilever strength testing by about 13%. Remarkably close correlation between load-strain diagram at low-level and cantilever strength tests is obtained for Jaw Post as shown in Fig. 3.11. Failure of the Jaw Post occurs at 4,310 lbs cantilever load. The process of porcelain failure in the Jaw Post is presented in Fig. 3.12 from several frames of a digital video recording. The failure starts at the base of the top section, propagates down and destroys the middle section completely. A similar process was observed for Rigid Post.

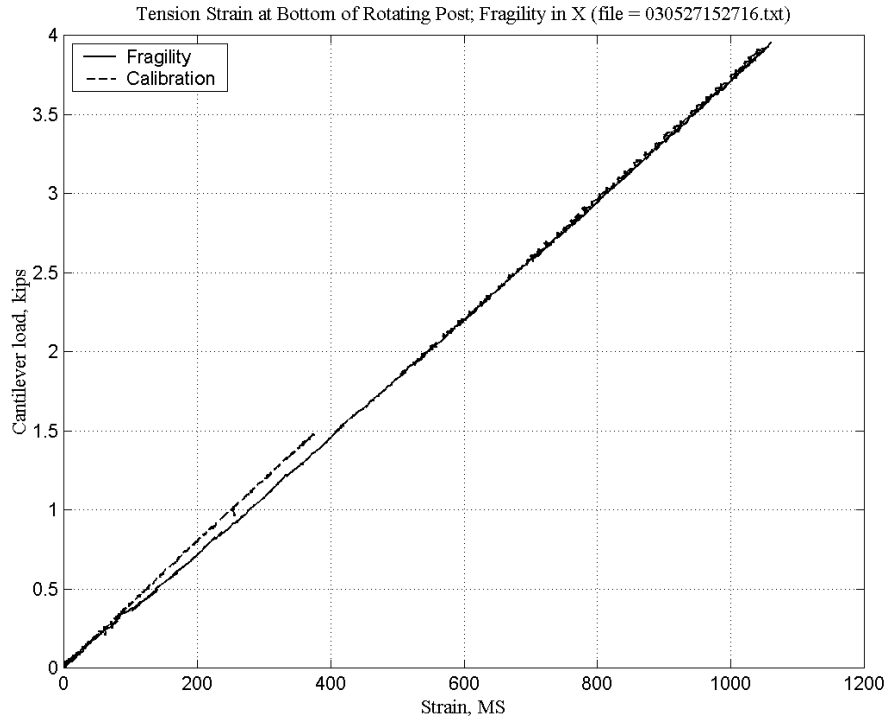
The mean ultimate cantilever load delivered from the cantilever strength tests for three insulator posts is about 4,140 lbs with a standard deviation of 176 lbs.

### **3.2.3 Data Provided by Insulator Manufacturer (Courtesy of NGK-Locke Insulators, Ltd.)**

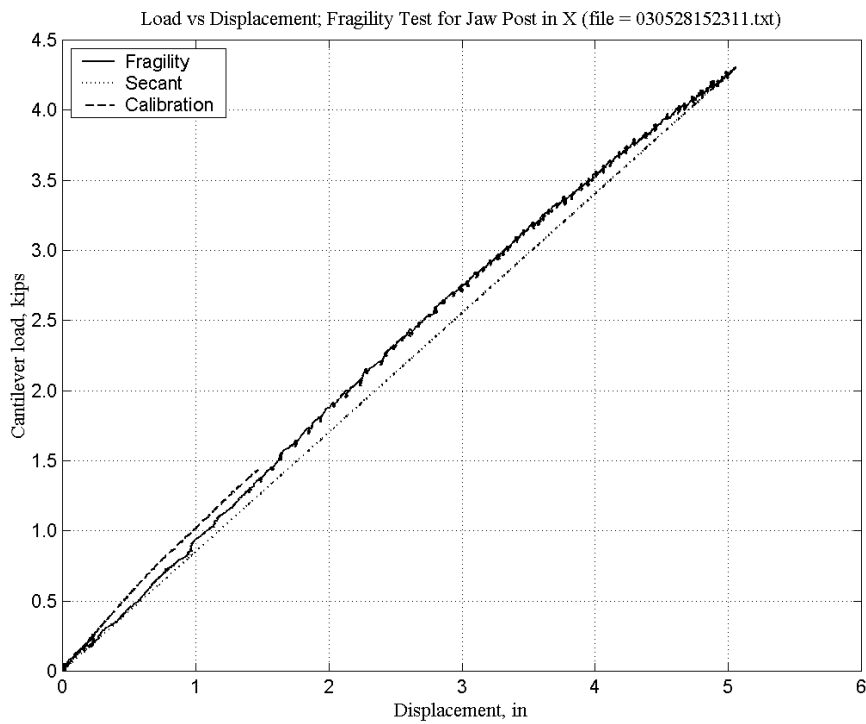
The cantilever strength data obtained from NGK-Locke Insulators, Ltd. (Japan) show that the mean breaking strength in bending for insulator posts (NGK-Locke Cat. No. 8A-69446A) used in the experimental program is 3800 lbs based on four tests, with a standard deviation of 178 lbs. When combined with the three breaking strength tests conducted in this experimental program, the mean breaking strength is 3944 lbs with a standard deviation of 242 lbs. Low-level cantilever tests conducted by NGK-Locke reveal a linear relationship between horizontal load and tip deflection, and a stiffness of about 1.08 kips/in up to about 1,200 lbs. This stiffness is close to the average stiffness found in this experimental program 0.93 kips/in. The cantilever rating of 8A-69446A is set by the manufacturer at 2900 lbs.

In addition to the data on 8A-69446A insulator posts, the manufacturer has also provided breaking strength data on a similar model (PX0603). PX0603 consists of three sections each having the same core diameters as the model used in the experimental program, but different end fittings. The mean breaking strength of 19 specimens of PX0603 is 3941 lbs with a standard deviation of 287 lbs. The cantilever rating for PX0603 is set by the manufacturer at 2500 lbs.

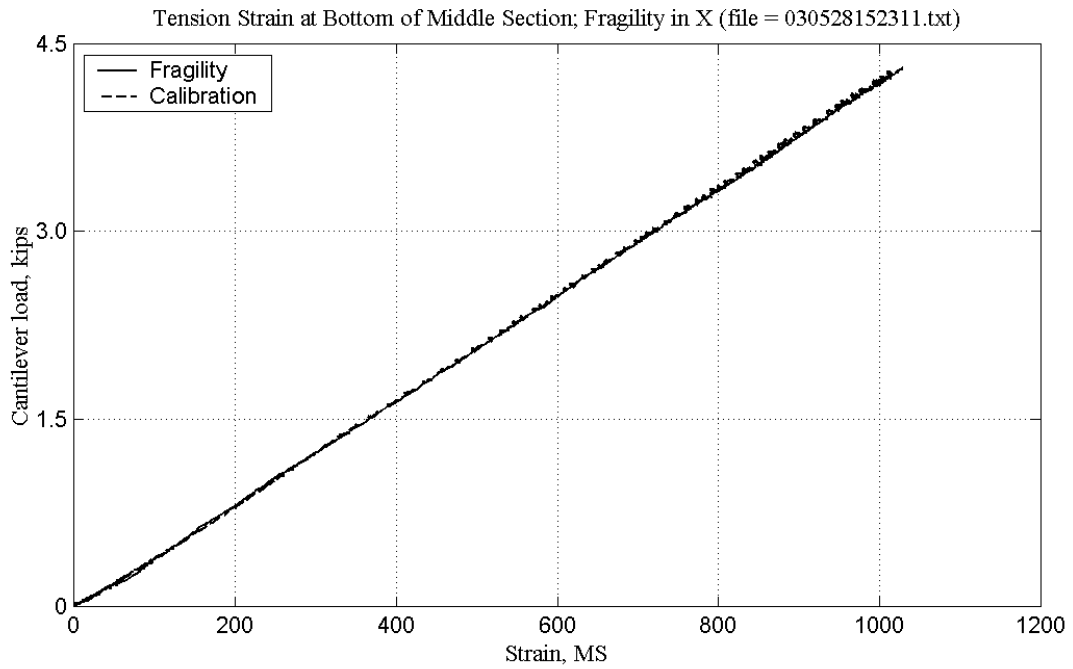
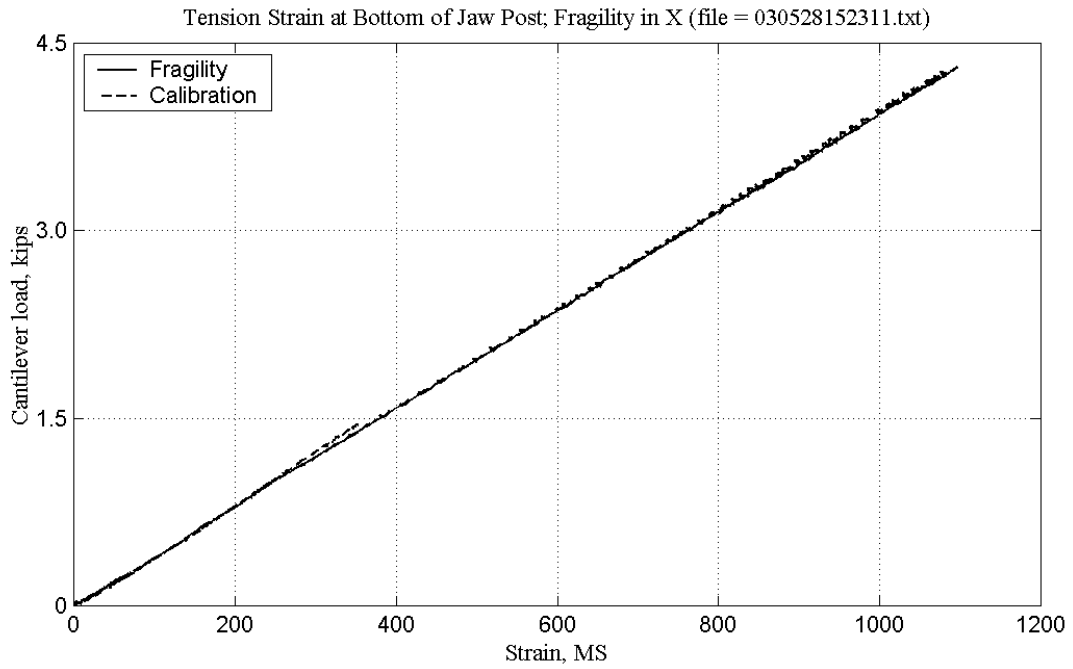
The breaking strength from these two models of insulators demonstrates a typical practice of insulator manufacturers, which is to set cantilever ratings substantially below the mean breaking strength. In essence, these rated strengths represent guaranteed minimum breaking strengths.



**Fig. 3.9. Load vs. tension strain for static cantilever strength test (Rotating Post in X axis).**



**Fig. 3.10. Load-deflection diagram for static cantilever strength test (Jaw Post in X axis).**



**Fig. 3.11. Load-tension strain diagram for static cantilever strength test (Jaw Post in X direction).**



Frame 1



Frame 2



Frame 3



Frame 4

Fig. 3.12. Step-by-step process of porcelain failure in Jaw Post.

### 3.2.4 Design properties of ceramics

Ceramics have excellent mechanical properties in compression, but when tensile loads are applied to them, they typically fail in a brittle manner at much lower load (Callister, 2003). The summary on strain gage data during cantilever strength tests confirms the difference of ceramics' behavior in compression and tension as presented in Table 3.5. For the same cantilever load the compression strain is greater for all sections of the posts than the tension strain recorded on opposite side of a cross section, as discussed in section 3.2.1.

Tensile fracture of a ceramic is caused by the presence of preexisting cracks and flaws in the material. When the material is placed in tension these cracks act as stress amplifiers, which in turn lead to a single dominant crack starting at the tip of a flaw. The dominant crack quickly propagates through the material. In compression, however, the cracks close, and do not behave like stress amplifiers. As a result the ceramic can handle compressive stresses very well. The presence of cracks and defects in the ceramic materials is called porosity. The porosity of a ceramic has a major effect on a ceramic's modulus of elasticity and modulus of rupture.

Therefore, a tension strain may serve as a better indicator to predict porcelain's failure. The ultimate tension strains recorded at the sections of the insulator posts during the cantilever strength tests are presented in Table 3.5, which also shows the section where the failure first started. The location of initial failure is consistent for all tests and is at the bottom of top section. Unfortunately, the strain gages on the top section are installed only in case of Rigid Post, so there is only one data point for tension strain at this location. The fact that the strain maxima are consistent for all cantilever strength tests suggests that even this one data point correctly represents the critical value for the tension strain. The critical tension strain is close to 1100 MS or 0.11% that is presented in bold in Table 3.5.

The strain at the top sections of the two other insulator posts in Table 3.5 is estimated from Table 3.6 that calculates bending stress at all levels of the post normalized to that at the bottom section. Assuming all porcelain is the same in the posts, the top section is the most critical and expected to fail first, as shown in the Table 3.6.

***Load Calculation Procedure used Throughout the Study.*** Based on the fact that the porcelain has lower strength in tension only negative strains representing tension in the material are used for equivalent load calculation. Negative strain is multiplied by the corresponding tension load factor and absolute value of equivalent load is calculated for gage readings in X and Y directions. The modulus of these two loads in two orthogonal directions is produced



computing the square root of sums of squared loads for a particular time step. The same procedure is repeated for another set of gages 90 degrees apart from this one. At the final stage the maximum value of these two moduli is obtained, that is called “modulus of the equivalent cantilever load” in the study.

**Table 3.5. Summary for strains in cantilever strength tests.**

| Post     | Section | Tension strain, MS | Compression strain, MS | Failure started at    | File         |
|----------|---------|--------------------|------------------------|-----------------------|--------------|
| Rigid    | Bottom  | 1080               | 1290                   |                       | 030528131501 |
|          | Middle  | 1000               | 1220                   |                       |              |
|          | Top     | <b>1130</b>        | 1270                   | Bottom of top section |              |
| Rotating | Bottom  | 1060               | 1290                   |                       | 030527152716 |
|          | Middle  |                    |                        |                       |              |
|          | Top     | 1103*              |                        | Bottom of top section |              |
| Jaw      | Bottom  | 1100               | 1280                   |                       | 030528152311 |
|          | Middle  | 1030               | 1210                   |                       |              |
|          | Top     | 1145*              |                        | Bottom of top section |              |

\*calculated for cantilever loading of the tapered multi-sectional insulator post (Table 3.6).

**Table 3.6 Stress estimation for cantilever loading of multi-sectional insulator post.**

| Section | $S_x, \text{in}^3$ | Moment's arm, in | Stress normalized to that at bottom section |
|---------|--------------------|------------------|---|
| Top     | 11.7               | 47.88            | 1.04  |
| Middle  | 26.71              | 97.88            | 0.93  |
| Bottom  | 37.93              | 148.88           | 1.00  |

**Strength vs Calibration Load Factors.** A set of tests to estimate the cantilever strength of the insulators was conducted after completion of the switch testing. The switch was disassembled and the three posts were tested in static pull-back test to failure as discussed above. The strength test setup is similar to that for calibration test. The load-vs-strain plots show that the load factor did not change significantly, therefore (1) the dynamic testing did not affect significantly the elastic properties of the insulator, and (2) the ceramic insulator performed elastically up to failure. Tables 3.3 and 3.4 present load factors before and after the switch’s dynamic testing, which confirms that the tension load factors change is 10% for all insulator posts, near the accuracy of test measurements.

### 3.2.5 Conclusions

The slope in a load-strain diagram for the porcelain sections and the posts depends on a sign of the strain. The tension strain develops a steeper slope than that in compression by up to 20%. The difference in the slope may be related to material properties of the ceramic and/or boundary condition effects. Since the strain gages were installed in immediate vicinity of joints between the sections, the bolted joints, a mortar between ceramic and a cap, a gap size between ceramic and the cap, and other factors may affect the strain reading. The small changes in overall stiffness and load-strain slope for the insulator posts indicates that the material properties of the insulator post are close to linear up to failure and the dynamic tests did not affect the insulators. The elastic stiffness of post estimated during calibration tests is close to that provided by the manufacturer (NGK Insulators, Ltd.). The failure load is close to that repeated by the manufacturer for similar insulator posts.

## **4 Support Mounted Switch with Original Design**

The chapter presents the test results for a switch with unreinforced base called the Original Switch. The tests were conducted only at low levels up to 0.25g pga. Since the equivalent cantilever loads in the insulator posts at 0.25g pga appeared to be greater than the allowable loads only a limited number of tests were conducted with the Original Switch. The base of the switch was reinforced for proceeding to more severe qualification testing. This chapter discusses the testing and performance of the Original Switch with unreinforced base.

### **4.1 SWITCH RESPONSE AT LOW-LEVEL DYNAMIC TESTING**

The switch manufacturer (Southern States, Inc., Georgia) provided two design modifications for type “EV-1” 550 kV 4000 A switch that are called Original Switch and Modified Switch in this report. The main difference between the two is in details of the fixture at the base of the switch where the insulators are attached to the base. The design modifications were developed prior to the qualification test program and are based on extensive testing (Wyle Laboratories, 1993) and numerical analysis (Gundy & Associates, Inc, 2002).

The approach of the experimental study was to start from the most vulnerable type of switch design and proceed with testing of the Modified Switch until the seismic qualification requirements were satisfied in accordance with the IEEE 693 document (IEEE, 1998). The decision to modify the switch design was based on the equivalent cantilever load for the insulators, which was estimated from strain gage data during low-level dynamic tests (up to 0.25g pga).

#### **4.1.1 Experimental Program**

The switch was assembled on the earthquake simulator platform to conduct a static pullback, a free-vibration, a resonance search, and a time history testing. The Original Switch was assembled

and tested only on 14 ft tall supports with the main blade in closed position and the grounding blade in open position. A total weight of the switch was estimated as 4,130 lbs and a total weight of supports was about 1,620 lbs.

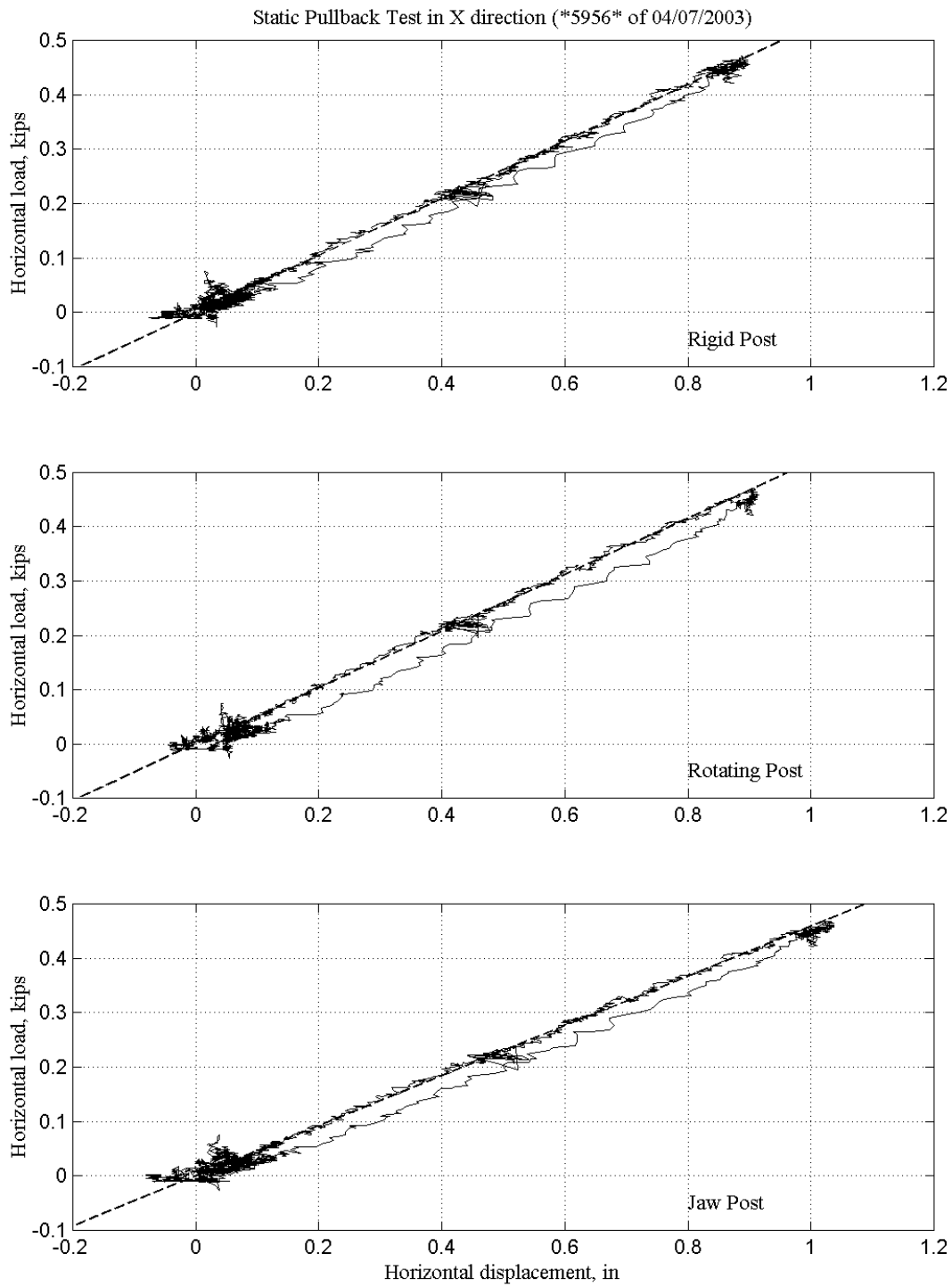
#### **4.1.2 Summary on Static Pullback, Free Vibration, and Resonance Search Tests**

The static pullback test was conducted by pulling the top part of the switch horizontally direction with a load up to 480 lbs and recording the deflection. The testing was conducted in two principal directions, and at least two tests in each direction were performed. The elastic stiffness of the switch in X direction (out of plane) is estimated as 0.50 kips/in, whereas in Y direction (in plane) it is estimated as 1.25 kips/in. Typical plots for horizontal load vs. deflection relationship for X and Y directions are presented in Figs. 4.1 and 4.2.

Free vibration tests are also performed in the two principal directions. The results for free vibration tests and resonance search tests were consistent showing a natural frequency in X direction at 1.6 Hz, and 2.5 Hz in the Y direction. Critical damping was estimated as 1% for both directions.

#### **4.1.3 Equivalent Cantilever Load in Insulator Posts During Time History Tests**

At the next stage of testing the switch was tested dynamically by means of the IEEE-compatible Landers strong motion (Landers5L) at two amplitudes: 0.125 g and 0.25 g pga. From the previous experience of the project team and Southern States test experience with 500 kV switches, the porcelain insulators were identified as a likely critical element. Based on the value of the strain recorded at the bottom of posts the equivalent cantilever loads at the posts were estimated. The calculations showed that the porcelain insulators are overstressed (especially Rigid Post) even for these low levels of testing. Table 4.1 presents the maximum equivalent cantilever load for two principal directions and the maximum of load modulus (all associated with negative or tension strain). The equivalent load calculation was based on use equivalent load factors or load-strain slopes delivered from the calibration test for insulator posts (Table 3.3). The modulus of the equivalent load associated with negative strain was computed for each time data point and only the negative part of the strain record for each direction was used in the computation. The variation in the maximum equivalent cantilever load and the modulus of



**Fig. 4.1. Load versus deflection plots for out of plane static pullback test (Original Switch).**

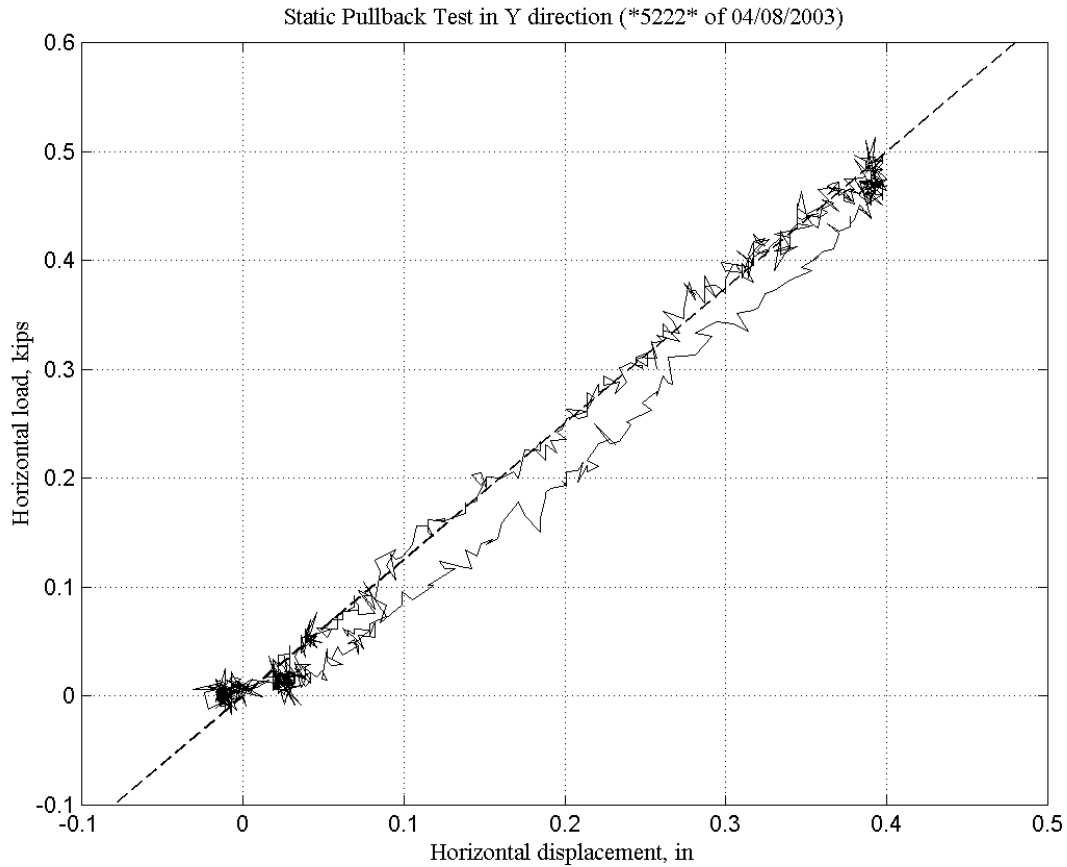


Fig. 4.2. Load versus deflection plots for in-plane static pullback test (Original Switch).

Table 4.1. Equivalent cantilever load estimations for insulator posts in Original Switch

| No. | Target pga, g | Direction | Post     | Equivalent cantilever load, lbs | Modulus of equivalent cantilever load, lbs |
|-----|---------------|-----------|----------|---------------------------------|--|
| 1   | 0.125         | X         | Rigid    | 727                             | 871  |
|     |               | Y         | Rigid    | 654                             |  |
|     |               | X         | Rotating | 181                             | 195  |
|     |               | Y         | Rotating | 161                             |  |
|     |               | X         | Jaw      | 452                             | 690  |
|     |               | Y         | Jaw      | 616                             |  |
| 2   | 0.25          | X         | Rigid    | 1536                            | 1552                                       |
|     |               | Y         | Rigid    | 1051                            |  |
|     |               | X         | Rotating | 332                             | 334  |
|     |               | Y         | Rotating | 264                             |  |
|     |               | X         | Jaw      | 923                             | 1440                                       |
|     |               | Y         | Jaw      | 1048                            |  |

equivalent cantilever load reveals close to a linear trend from 0.125 g to 0.25g levels.

Strains recorded at two sides (90 degrees apart) at the bottom cross section of each post at 0.25g level are presented in Figs. 4.3 and 4.4. In the X direction, the maximum strain in the Rigid Post is about 50% greater than that in the Jaw Post, whereas the strain in the Rotating Post is about four times lower than that for the Rigid Post. This conclusion is consistent with equivalent load estimations presented in Table 4.1. It is obvious that the fixture at the base of the Rotating Post is more flexible than that at the base of the Rigid Post, which causes the Rigid Post to carry a portion of inertial load of the Rotating Post as well, resulting in overstressing. Based on these load estimates, testing of the Original Switch was terminated and the Modified Switch was examined next.

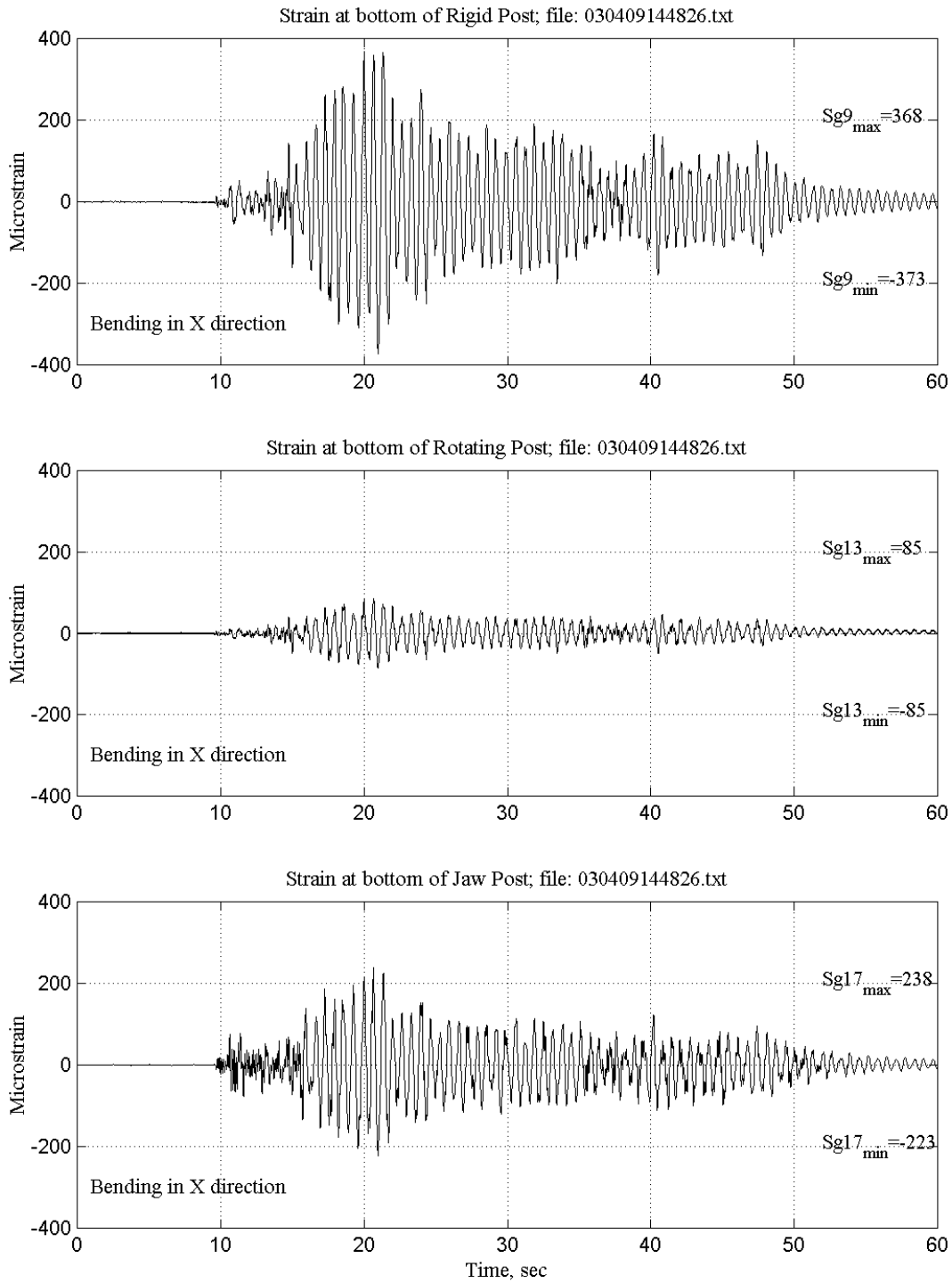


Fig. 4.3. Original Switch - strain at bottom of posts associated with bending in X direction.



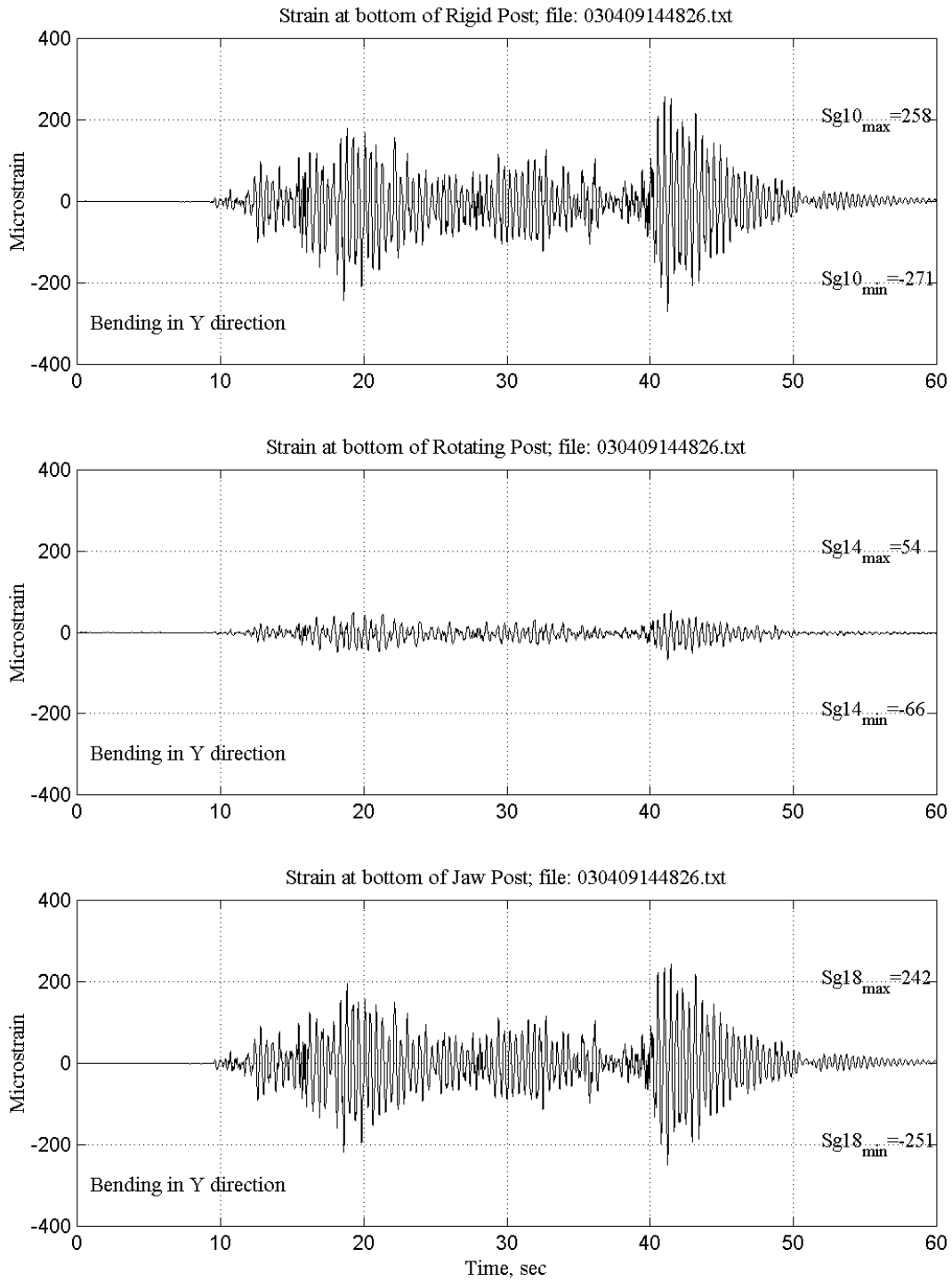


Fig. 4.4. Original Switch - strain at bottom of posts associated with bending in Y direction.

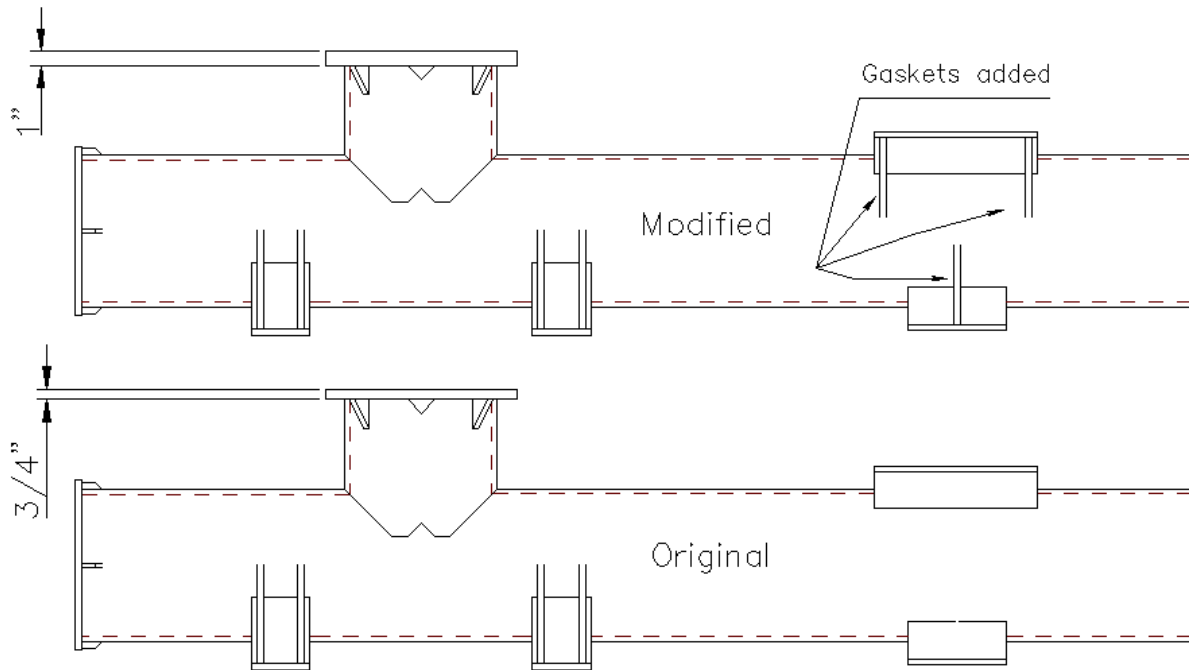
## 5 Qualification Tests for Modified Switch on Supports

The chapter presents the IEEE 693 (IEEE, 1998) qualification testing of the Modified Switch mounted on supports. In a companion PEER report (Takhirov et al, 2004), an IEEE-compatible time history called TestQke4IEEE is developed for the IEEE seismic qualification testing, as summarized in Appendix A. This experimental study extensively uses two earlier versions of TestQke4IEEE, filtered to accommodate the capacity limits of the earthquake simulator at PEER: Landers5L is for testing up to high RRS level and Landers5H for the high PL.

### 5.1 DETAILS OF DESIGN IMPROVEMENTS IN MODIFIED SWITCH

The main strategy in design improvement was to reinforce the fixture of all posts to the base, especially for the Rotating Post. In the Modified Switch the base plates were replaced by thicker plates and the leveling bolts are replaced by larger bolts at locations of Rigid and Jaw Posts. The Rotating Post fixture was reinforced by adding gussets to the base, replacing a shaft with ball bearings to a shaft with a conical bearing, and increasing prestress load in the fixture. Figure 4.5 presents the differences in fixture design for Rigid and Rotating Post locations. A photo of these two base designs both supplied by the manufacturer is presented in Fig. 4.6. On the left side of the photo base of Original Switch is presented, whereas base of Modified Switch is shown on the right side (both present views of the Rigid Post end).

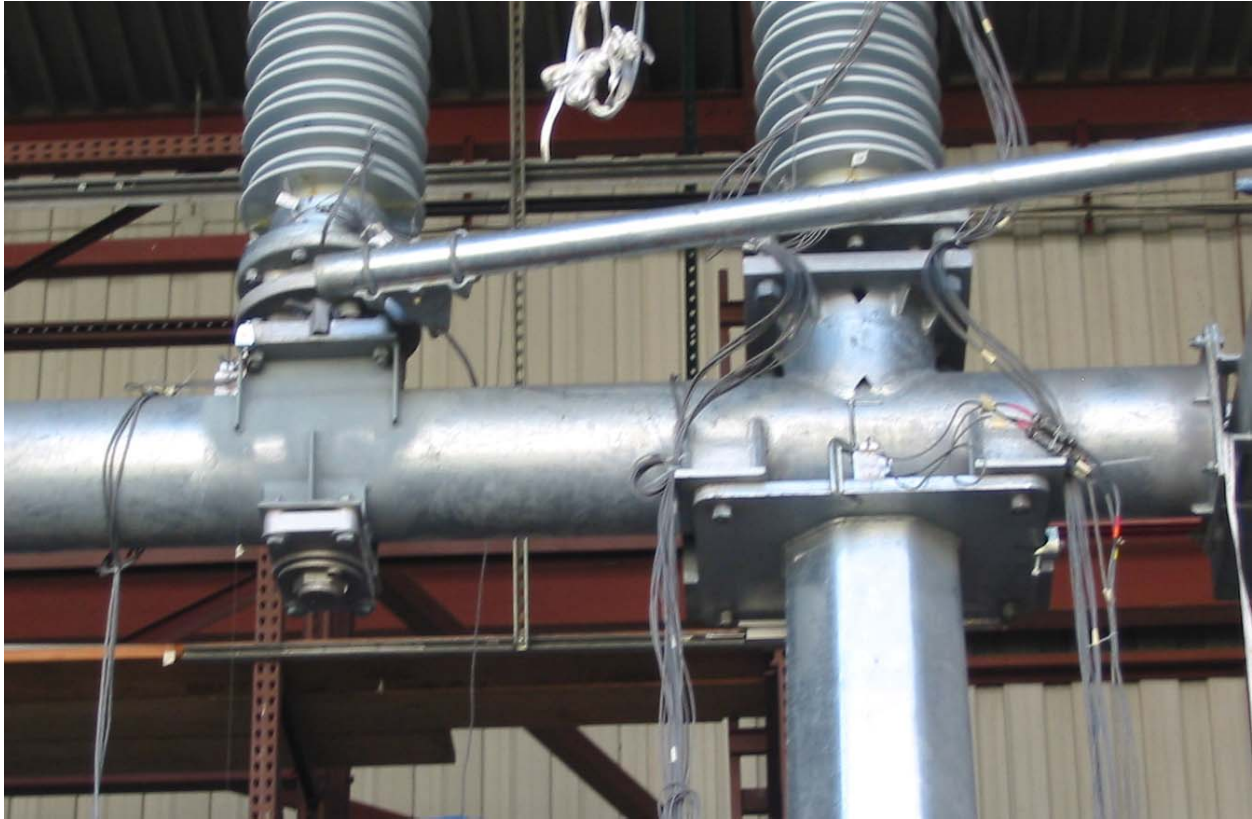
All following tests were conducted on the Modified Switch, and Fig. 4.7 shows the fully assembled switch at one of test stages.



**Fig. 4.5. Reinforcements details at base of switch.**



**Fig. 4.6. Difference in base design for Original (left) and Modified (right) Switches**



**Fig. 4.7. Modified Switch assembled on reinforced base.**

## **5.2 STIFFNESS, RESONANT FREQUENCY, AND DAMPING**

The elastic stiffness of the Modified Switch was estimated from a static pullback test conducted in two horizontal directions. The elastic stiffness of the switch in X direction (out of plane) is estimated as 0.60 kips/in, whereas in Y direction (in plane) it is estimated as 1.66 kips/in, which is greater than that for the Original Switch.

Free vibration tests were also performed in two horizontal directions showing a resonant frequency of the switch in the X direction as 1.7 Hz and 2.6 Hz in the Y direction. Critical damping is estimated as 1% for both horizontal directions. The resonant frequency and damping in two horizontal directions was confirmed by random time history and sweep signal testing at low levels of pga. The summary on the elastic stiffness, the resonant frequency, and the damping is presented in Table 5.1. The plots for resonance search tests are shown in Appendix C (Figs. C.2-C.4).

**Table 5.1. Elastic stiffness, resonant frequency, and damping of Modified Switch mounted on supports.**

| <b>Direction</b> | <b>Elastic stiffness, kips/in</b> | <b>Resonant frequency, Hz</b> | <b>Damping, %</b> |
|------------------|-----------------------------------|-------------------------------|-------------------|
| X                | 0.6                               | 1.7                           | 1.0               |
| Y                | 1.66                              | 2.6                           | 1.0               |

### **5.3 TIME HISTORY TESTING**

#### **5.3.1 Test Response Spectra at Various Severity Levels of Testing**

At the next stage of testing the switch was tested dynamically by means of the IEEE-compatible Landers time history at several severity levels in incremental order from 0.125g to 1.0g target pga. Test response spectra (TRS) were computed at 2% damping and are based on acceleration data recorded at the rigid foundations, and for each level the TRS is plotted at 1/12 octave frequency resolution and compared with the IEEE required response spectrum, as shown in Figs. 5.1-5.5. Spectral tolerance limits of  $-10\%/+40\%$  about the target spectra as discussed in Appendix A are shown in the plots. These tolerance limits are part of the new recommended requirements, and not part of IEEE 693-1997.

Because of limitations of the earthquake simulator performance, a number of the spectral ordinates of the TRS are below the required spectrum. The valleys below the IEEE spectrum are sometimes deeper than  $-10\%$  in the frequency range of the IEEE spectral plateau. The TRS valleys expressed in percents of the plateau spectral acceleration for the RRS testing at 0.75g and the high PL testing at 1.0g are presented in Figs. 5.6-5.7. The vertical dashed line marks the resonant frequency of the Modified Switch in the direction specified. These plots are similar to the plots in Figs. 5.4-5.5 presenting tolerance between the TRS and the required response spectra for the frequency range from 0.3 Hz to 33 Hz, but focused only on the spectral accelerations below and above the IEEE spectra that represent possible undertesting and overtesting of the switch in frequency range from 1 Hz to 20 Hz.

The spectral accelerations of the TRS at the resonant frequencies in both horizontal directions are presented in Fig. 5.8, demonstrating almost linear performance of the table. The earthquake simulator slightly under performs at the high levels of testing in the horizontal directions and it has significant underperformance in the vertical direction.

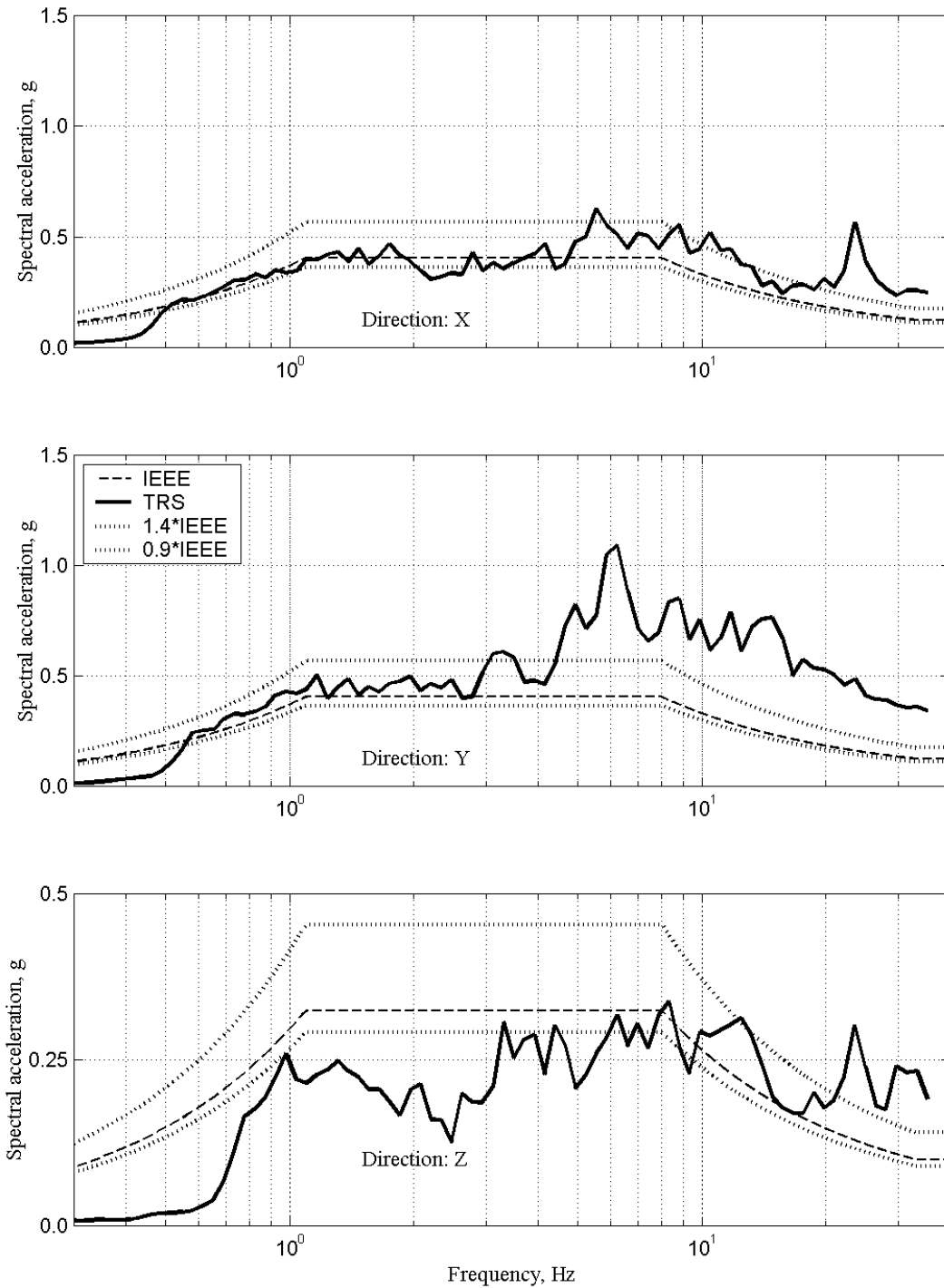


Fig. 5.1 Test response spectra of the Modified Switch testing at 0.125g for Landers5L.

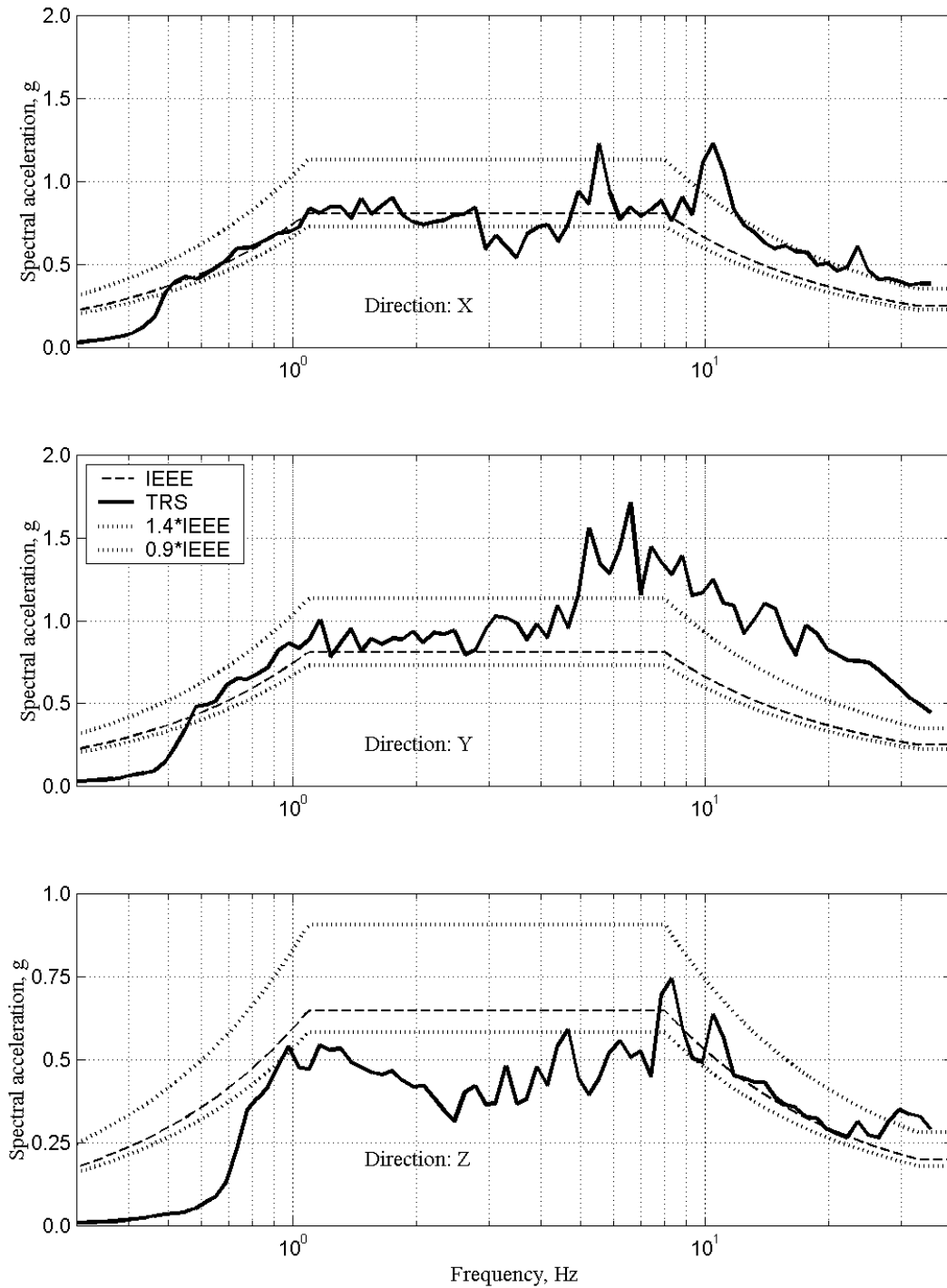


Fig. 5.2 Test response spectra of the Modified Switch testing at 0.25g for Landers5L.

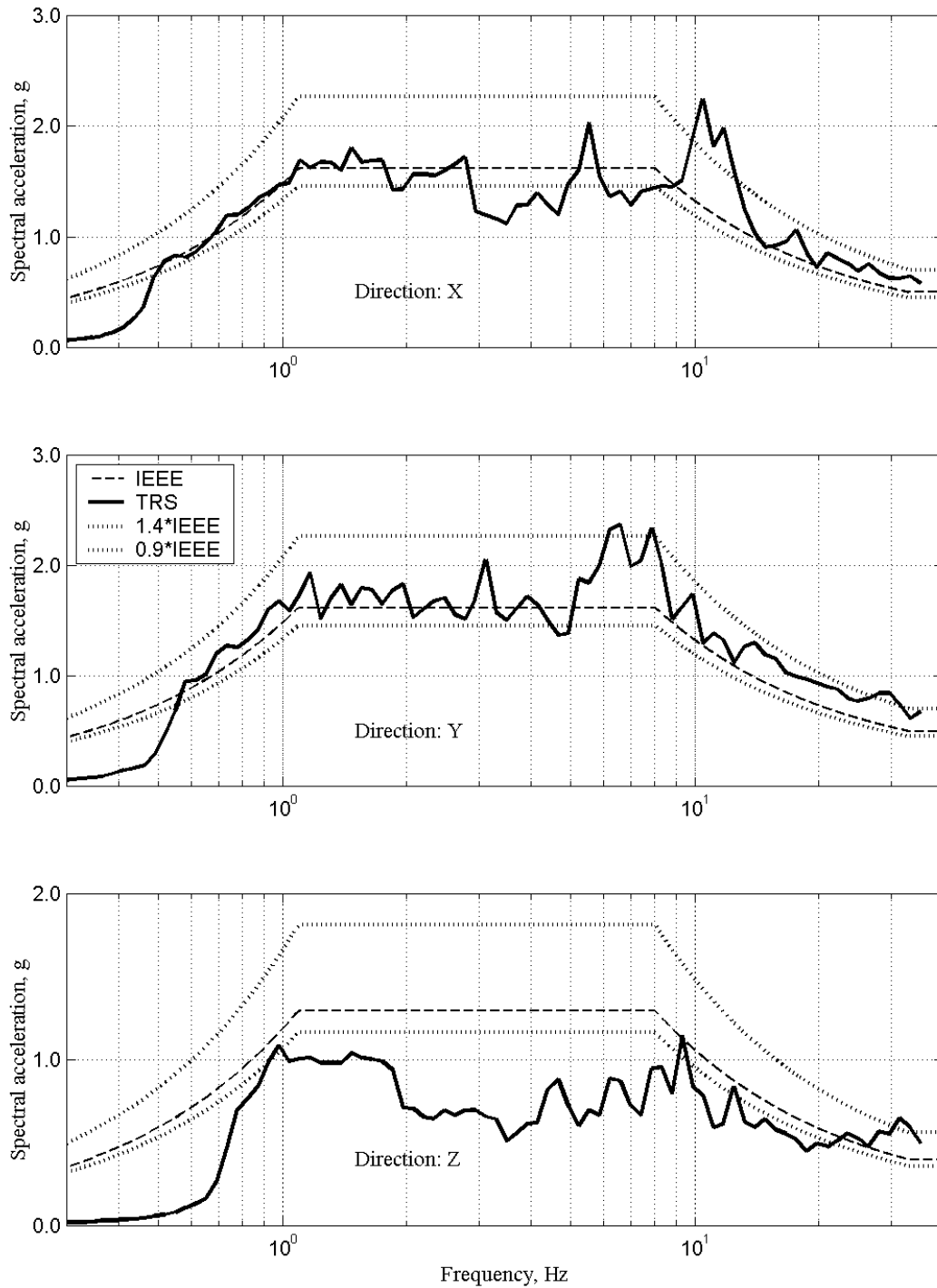


Fig. 5.3 Test response spectra of the Modified Switch testing at 0.5g for Landers5L.



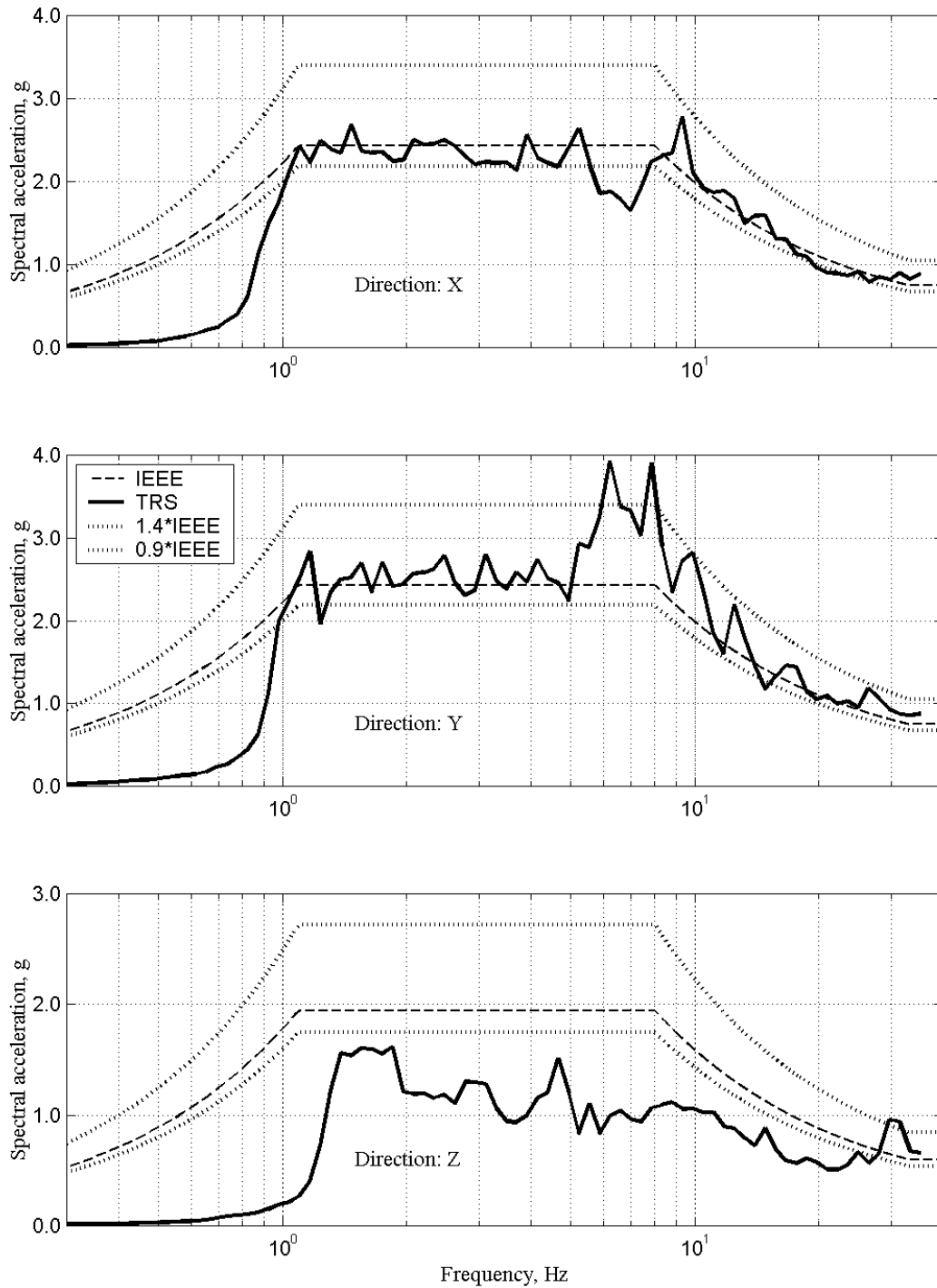


Fig. 5.4 Test response spectra of the Modified Switch testing at 0.75g for Landers5H.

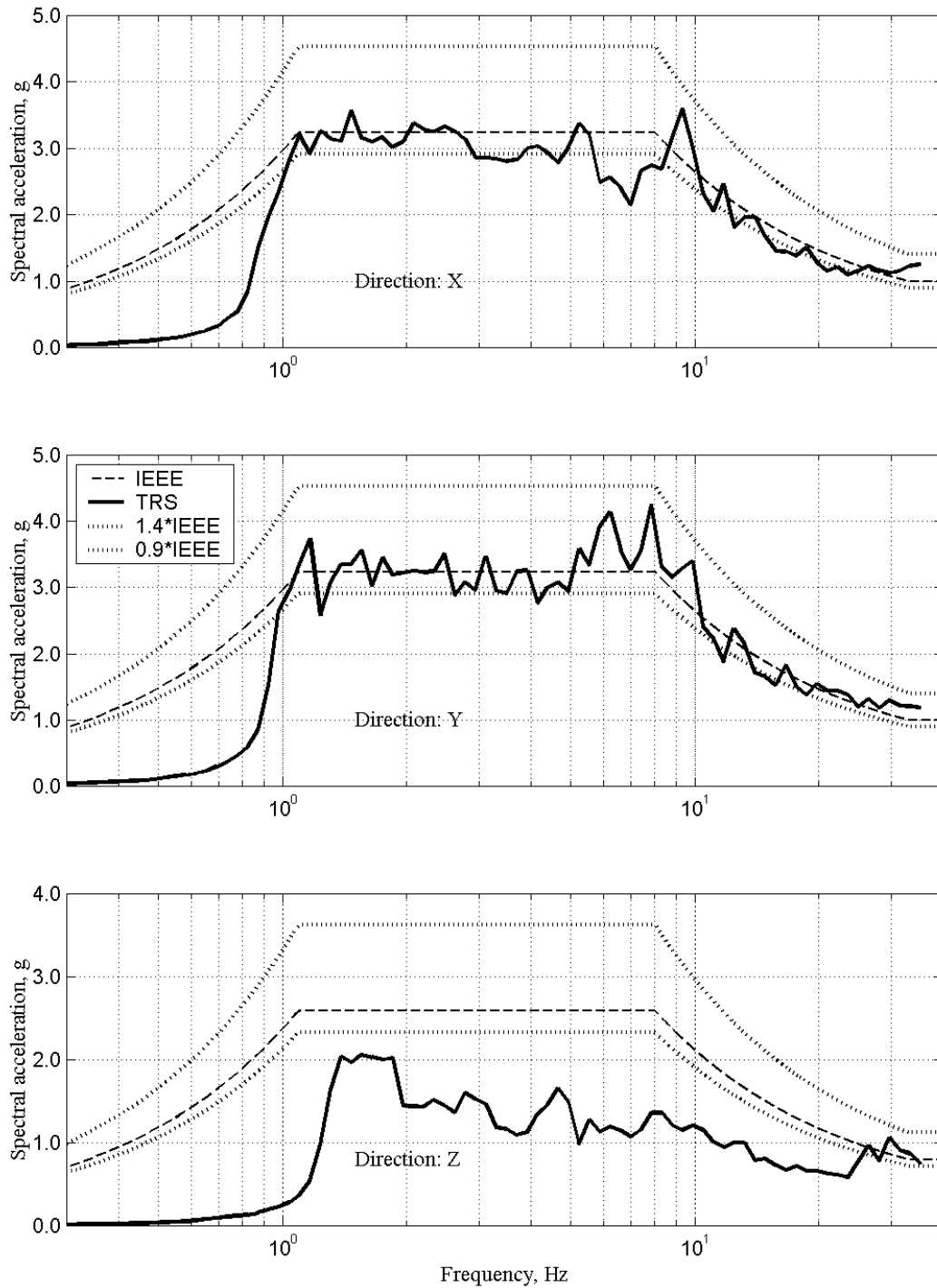
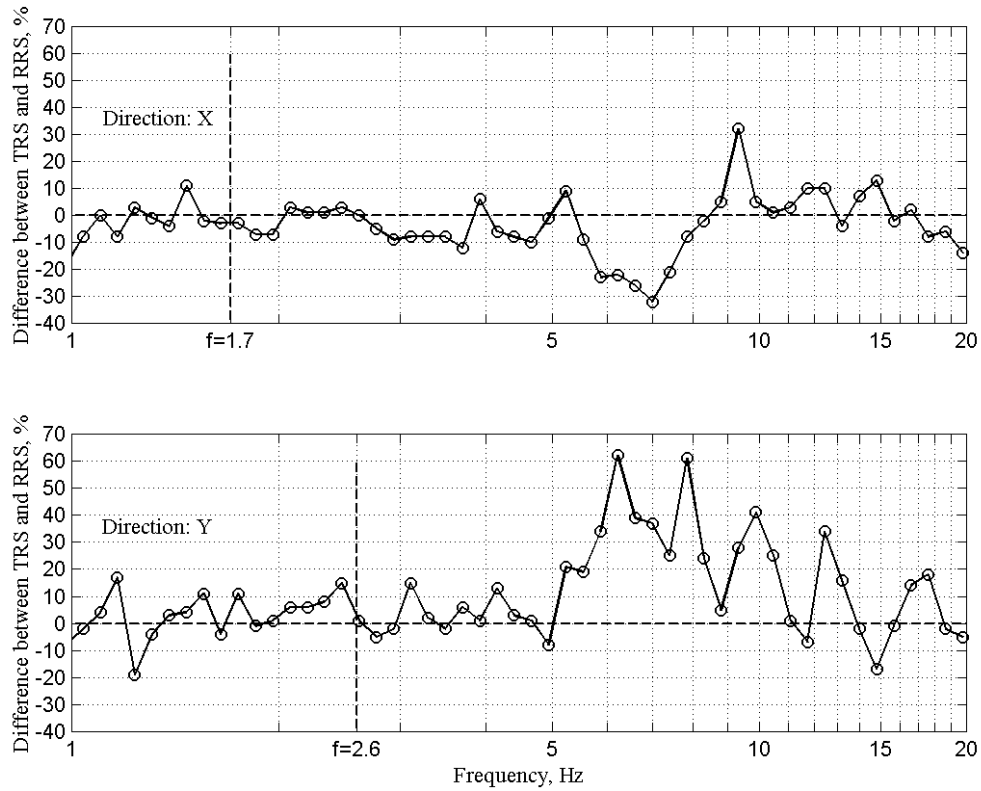
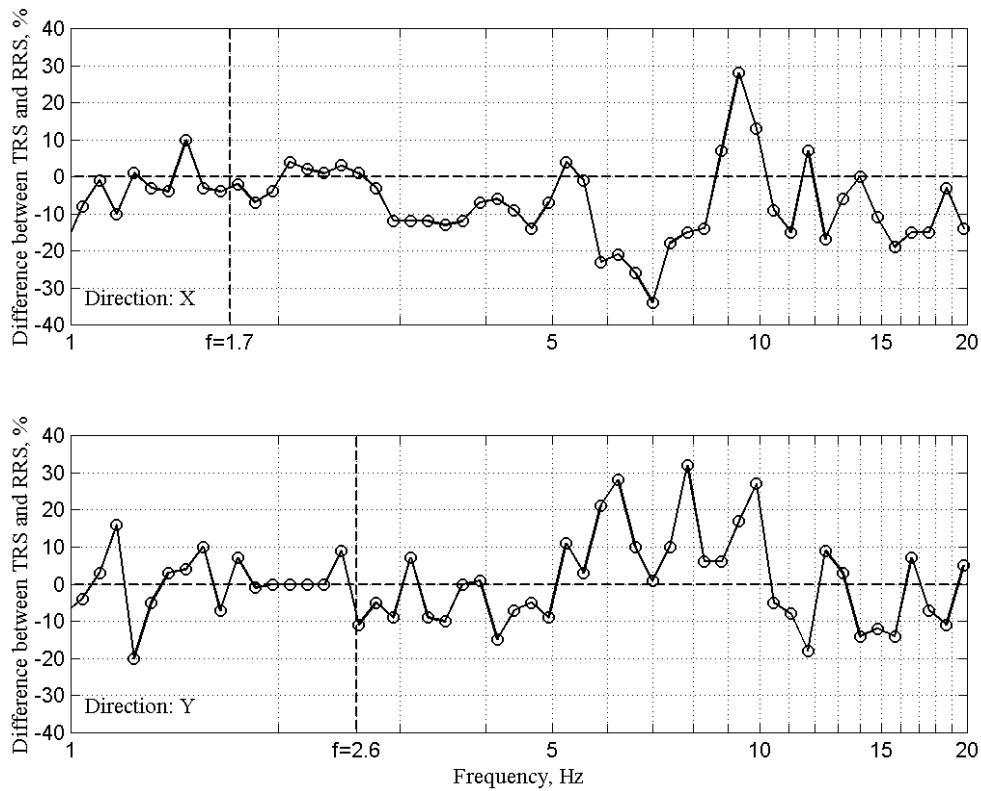


Fig. 5.5 Test response spectra of the Modified Switch testing at 1.0g for Landers5H.



**Fig. 5.6** Difference between TRS and high RRS for Modified Switch testing at 0.75g (Landers5H).



**Fig. 5.7** Difference between TRS and high PL for Modified Switch testing at 1.0g (Landers5H).

Since the switch has no resonant frequency below 12 Hz in vertical direction, the underperformance in vertical direction is considered acceptable.

### **5.3.2 Equivalent Cantilever Load in Insulator Posts**

Table 5.2 presents the maximum of the equivalent cantilever load for the two horizontal directions and the maximum modulus of the load, all associated with a negative (tension) strain. The variation in the maximum equivalent cantilever load is quite consistent and is close to linear up to 0.5g target pga. The modulus of equivalent cantilever load reveals a linear trend from 0.125g to 0.5g target pga for all three posts, although the trend became nonlinear after 0.5g target pga for the Rigid and Jaw Posts, as shown in Fig. 5.9.

IEEE 693 (IEEE, 1998) provides two options for seismic qualification testing, namely, testing at RRS level and testing at PL. For high seismic qualification, the RRS testing shall be conducted at 0.5g pga, whereas the PL testing shall be conducted at 1.0g pga. In the first case the acceptance criteria are that the stresses in the most vulnerable parts of a testing article shall be below the allowable stresses, no structural damage shall occur and the equipment shall be able to perform its electrical functions. This option requires monitoring strain during qualification testing. The PL testing option only requires structural integrity of equipment during and after the test, and the ability to perform its electrical functions. The porcelain posts are rated at 2900 lbs equivalent cantilever load. At the RRS level of 0.5g target pga the porcelain is stressed more than the allowable of 50% of the insulator rating at the Rigid and Jaw Posts. This fact means that the Modified Switch did not pass high seismic qualification testing based on the RRS option, because the Rigid Post was stressed to 92% and Jaw post to 58% of the insulator rating, as shown in Table 5.2.

### **5.3.3 Summary of Other Response**

Displacements, accelerations, and strains were monitored at numerous critical locations on the disconnect switch and supporting structure, as required by IEEE 693. The maximum displacements at the top of the insulators posts are summarized in Table 5.3, and the maximum accelerations are summarized in Table 5.4. A summary of the maximum strains, stresses, and equivalent cantilever loads on the posts is provided in Table 5.5. The stresses at strain gage locations on the supports are less than, but close to the nominal 50 ksi yield stress of the support material. Since the strain gages were installed at 20-in above the base plate of the support, the

stress in the support at the base plate is estimated as 50 ksi, approximately equal to the yield stress of the steel.

### 5.3.4 Electrical Continuity and Resistance Checks

Low voltage continuity of the main circuit was monitored during each time history testing and no continuity interruptions were observed. Resistance of the main circuit was checked before and after tests with 0.75 and 1.0g target pga, and it showed that it was within allowable of up to 20% as required by IEC 60694 (IEC, 1996). For the shaking table tests, low-current capacity fuses are inserted into motor operator circuit, and are designed to break the circuit in the event that the motor operator is activated during shaking. The fuses of the motor operator are also checked for continuity to make sure that they were not blown during dynamic testing, and the switch's functionality and assembly alignment were also checked after 0.75g and 1.0g tests (Table 5.6).

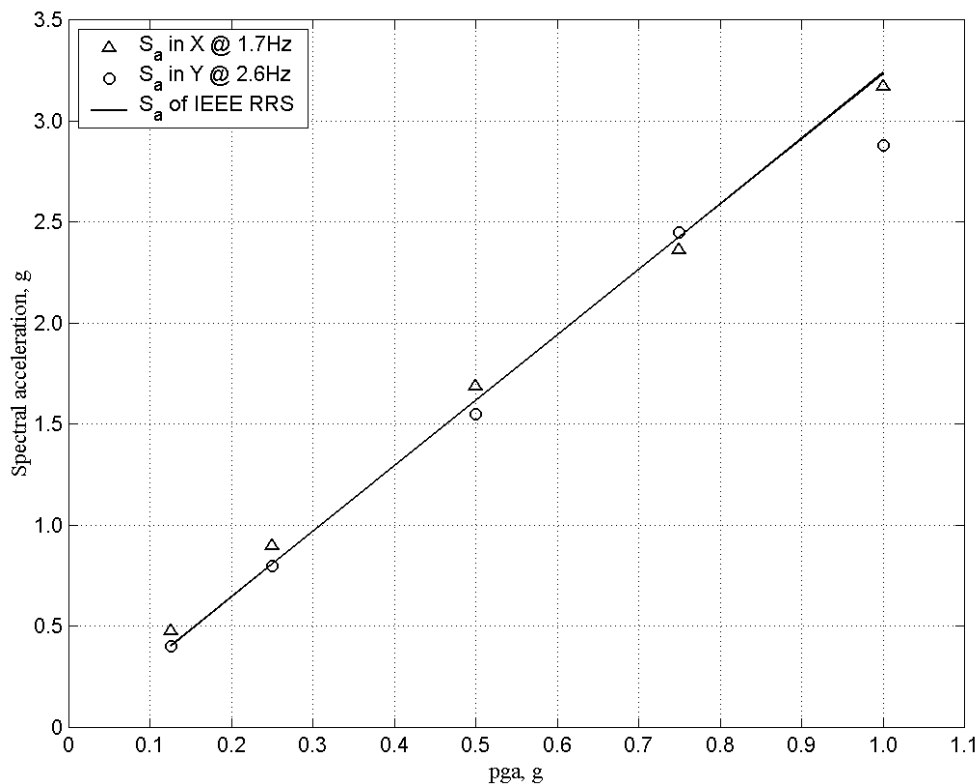


Fig. 5.8 Spectral accelerations of TRS at resonant frequencies for all levels of earthquake testing.

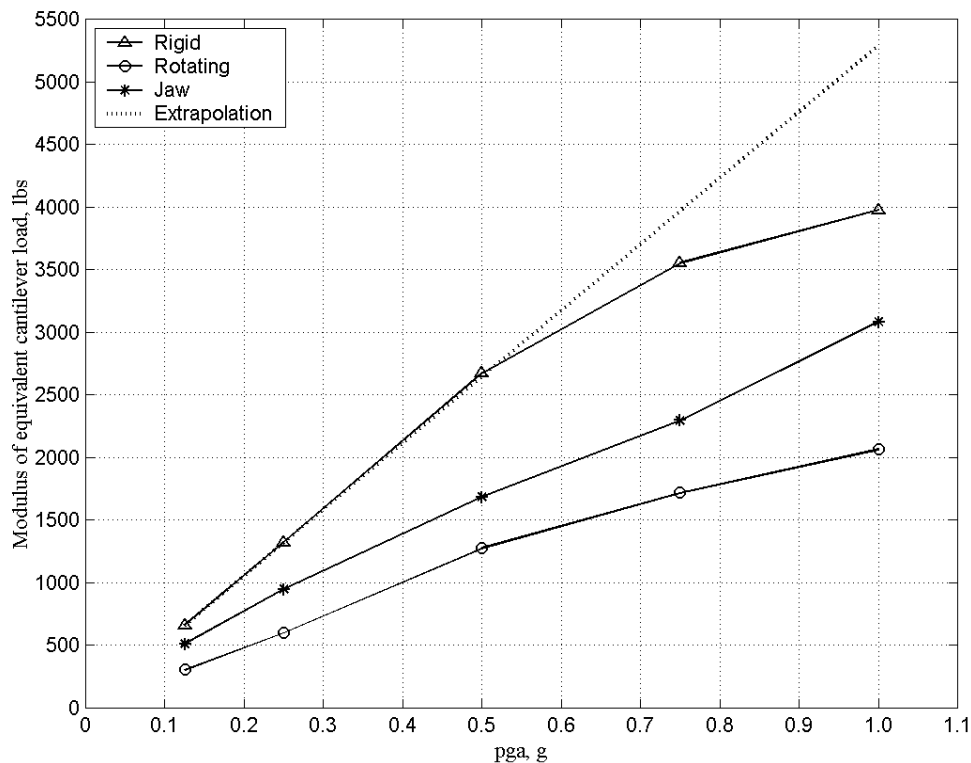


Fig. 5.8 Moduli of equivalent cantilever load for insulator posts for target pga.

Table 5.2. Equivalent cantilever loads at insulator posts for all severity levels.

| Target pga, g | Direction | Demand load (equivalent cantilever), lbs |          |      | Demand load/ Rated Cantilever load, % |          |            |
|---------------|-----------|--|----------|------|---------------------------------------|----------|------------|
|               |           | Rigid                                    | Rotating | Jaw  | Rigid                                 | Rotating | Jaw        |
| 0.125         | X         | 635                                      | 306      | 451  | 22                                    | 11       | 16         |
|               | Y         | 554                                      | 222      | 488  | 19                                    | 8        | 17         |
|               | Modulus   | 661                                      | 306      | 511  | 23                                    | 11       | 18         |
| 0.25          | X         | 1211                                     | 589      | 735  | 42                                    | 20       | 25         |
|               | Y         | 914                                      | 397      | 948  | 32                                    | 14       | 33         |
|               | Modulus   | 1322                                     | 601      | 948  | 46                                    | 21       | 33         |
| 0.50          | X         | 2459                                     | 1235     | 1302 | <b>85</b>                             | 43       | 45         |
|               | Y         | 1640                                     | 767      | 1672 | <b>57</b>                             | 26       | <b>58</b>  |
|               | Modulus   | 2673                                     | 1275     | 1686 | <b>92</b>                             | 44       | <b>58</b>  |
| 0.75          | X         | 3395                                     | 1704     | 1849 | <b>117</b>                            | 59       | 64         |
|               | Y         | 2558                                     | 1128     | 2241 | 88                                    | 39       | 77         |
|               | Modulus   | 3552                                     | 1717     | 2296 | <b>122</b>                            | 59       | 79         |
| 1.0           | X         | 3826                                     | 2061     | 2546 | <b>132</b>                            | 71       | 88         |
|               | Y         | 3103                                     | 1301     | 2703 | <b>107</b>                            | 45       | 93         |
|               | Modulus   | 3977                                     | 2066     | 3081 | <b>137</b>                            | 71       | <b>106</b> |

**Table 5.3. Maximum displacements (relative to table) at all elevations of Modified Switch**

| Target pga, g | Direction | East support, in | West support, in | Rigid post, in | Rotating post, in | Jaw post, in | From Rotating To Jaw posts, in |
|---------------|-----------|------------------|------------------|----------------|-------------------|--------------|--------------------------------|
| 0.125         | X         | 0.34             | 0.48             | 1.57           | 2.75              | 1.57         |                                |
|               | Y         | 0.25             | 0.25             | 1.05           | 1.05              | 0.98         | 0.08                           |
|               | Modulus   | 0.34             | 0.48             | 1.58           | 2.75              | 1.58         |                                |
| 0.25          | X         | 0.68             | 1.03             | 3.28           | 5.84              | 3.45         |                                |
|               | Y         | 0.45             | 0.44             | 1.92           | 1.92              | 1.84         | 0.30                           |
|               | Modulus   | 0.71             | 1.03             | 3.35           | 5.88              | 3.51         |                                |
| 0.50          | X         | 1.34             | 2.17             | 6.87           | 12.43             | 7.21         |                                |
|               | Y         | 0.74             | 0.71             | 3.67           | 3.67              | 3.42         | 1.17                           |
|               | Modulus   | 1.39             | 2.20             | 7.23           | 12.64             | 7.56         |                                |
| 0.75          | X         | 1.86             | 2.88             | 10.20          | 17.75             | 10.20        |                                |
|               | Y         | 1.23             | 1.20             | 6.33           | 6.33              | 5.34         | 3.01                           |
|               | Modulus   | 1.91             | 2.88             | 10.46          | 17.95             | 10.50        |                                |
| 1.0           | X         | 2.39             | 3.40             | NA             | NA                | NA           |                                |
|               | Y         | 1.48             | 1.41             | NA             | NA                | NA           | 4.13                           |
|               | Modulus   | 2.40             | 3.42             | NA             | NA                | NA           |                                |

Note: Displacement transducers were disconnected for 1.0g tests.

**Table 5.4. Maximum accelerations (relative to table) at all elevations of Modified Switch**

| Target pga, g | Direction | Table, g | West support, g | East support, g | Rigid post, g | Rotating post, g  | Jaw post, g | Blade, g          |
|---------------|-----------|----------|-----------------|-----------------|---------------|-------------------|-------------|-------------------|
| 0.125         | X         | 0.21     | 0.65            | 0.82            | 1.07          | 1.32              | 1.56        | 2.46              |
|               | Y         | 0.30     | 0.60            | 0.60            | 1.16          | 1.27              | 1.00        | 1.28              |
|               | Z         | 0.12     | 0.17            | 0.17            | 0.23          | 0.43              | 0.21        | 0.66              |
|               | Modulus   |          | 0.70            | 0.85            | 1.18          | 1.37              | 1.60        | 2.46              |
| 0.25          | X         | 0.39     | 0.92            | 0.82            | 1.94          | 2.02              | 1.48        | 2.29              |
|               | Y         | 0.46     | 1.06            | 1.06            | 1.86          | NA <sup>(1)</sup> | 1.97        | 2.28              |
|               | Z         | 0.21     | 0.23            | 0.19            | 0.24          | 0.52              | 0.24        | 0.77              |
|               | Modulus   |          | 1.10            | 1.22            | 2.13          | NA <sup>(1)</sup> | 2.03        | 2.46              |
| 0.50          | X         | 0.53     | 1.58            | 1.15            | 3.97          | 4.16              | 2.14        | 4.14              |
|               | Y         | 0.60     | 1.41            | 1.43            | 3.17          | NA <sup>(1)</sup> | 3.60        | 4.16              |
|               | Z         | 0.31     | 0.31            | 0.25            | 0.44          | 0.90              | 0.59        | 1.86              |
|               | Modulus   |          | 1.61            | 1.55            | 4.51          | NA <sup>(1)</sup> | 3.63        | 4.40              |
| 0.75          | X         | 0.68     | 2.05            | 1.97            | 5.30          | 5.10              | 3.11        | NA <sup>(2)</sup> |
|               | Y         | 0.82     | 2.46            | 2.52            | 5.03          | NA <sup>(1)</sup> | 3.88        | NA <sup>(2)</sup> |
|               | Z         | 0.36     | 0.35            | 0.47            | 0.73          | 2.00              | 0.67        | 5.91              |
|               | Modulus   |          | 2.53            | 2.52            | 5.60          | NA <sup>(1)</sup> | 4.40        | 7.24              |
| 1.0           | X         | 1.04     | 2.12            | 2.27            | 5.64          | 5.43              | 4.63        | NA <sup>(2)</sup> |
|               | Y         | 1.14     | 2.44            | 2.43            | 5.24          | 5.91              | 3.98        | NA <sup>(2)</sup> |
|               | Z         | 0.47     | 0.56            | 0.51            | 1.29          | 3.87              | 1.14        | NA <sup>(2)</sup> |
|               | Modulus   |          | 2.81            | 2.77            | 6.73          | 7.00              | 5.37        | NA <sup>(2)</sup> |

Notes for Table 5.4:

- 1) accelerometer in Y direction is malfunctioning,
- 2) accelerometer is out of range (accelerations are greater than 5.0g).
- 3) see Fig. 2.1 for coordinate system definition.

**Table 5.5. Strain, stress, and equivalent cantilever loads at east (E) and west (W) supports.**

| Target pga, g | Direction | StrainE, MS | StrainW, MS | StressE, ksi | StressW, ksi | LoadE, kips | LoadW, kips |
|---------------|-----------|-------------|-------------|--------------|--------------|-------------|-------------|
| 0.125         | X         | 160         | 247         | 4.65         | 7.16         | 1.37        | 2.11        |
|               | Y         | 133         | 132         | 3.84         | 3.83         | 1.13        | 1.13        |
|               | Modulus   | 167         | 254         | 4.83         | 7.36         | 1.42        | 2.17        |
| 0.25          | X         | 336         | 496         | 9.74         | 14.37        | 2.87        | 4.23        |
|               | Y         | 234         | 238         | 6.79         | 6.90         | 2.00        | 2.03        |
|               | Modulus   | 351         | 505         | 10.18        | 14.65        | 3.00        | 4.31        |
| 0.50          | X         | 647         | 999         | 18.75        | 28.98        | 5.52        | 8.53        |
|               | Y         | 372         | 366         | 10.78        | 10.61        | 3.18        | 3.12        |
|               | Modulus   | 665         | 1018        | 19.29        | 29.51        | 5.68        | 8.69        |
| 0.75          | X         | 893         | 1322        | 25.90        | 38.34        | 7.63        | 11.29       |
|               | Y         | 637         | 634         | 18.48        | 18.39        | 5.44        | 5.42        |
|               | Modulus   | 893         | 1324        | 25.90        | 38.38        | 7.63        | 11.30       |
| 1.0           | X         | 1134        | 1543        | 32.89        | 44.76        | 9.68        | 13.18       |
|               | Y         | 723         | 723         | 20.96        | 20.96        | 6.17        | 6.17        |
|               | Modulus   | 1136        | 1553        | 32.95        | 45.04        | 9.70        | 13.26       |

### 5.3.5 Minor Anomalies After PL Test at 1.0g Target pga

The switch sustained the PL level of testing at 1.0g target pga without major structural damage and the electrical continuity of the switch was not interrupted. The switch functioned as required, although anomalies are observed in the after-test inspection. The stationary arc horn was bent by an impact during the test (Fig. 5.9). In addition, the joint of the vertical pipe with the box of the motor mechanism was dislocated (Fig. 5.10). Both anomalies were repaired easily, and appear to be amenable to simple corrective actions by the manufacturer.



**Table 5.6. Results of functionality inspection.****1 General information:**

|    |                     |                 |                 |
|----|---------------------|-----------------|-----------------|
| a) | Specimen            | Modified Switch | Modified Switch |
| b) | Mounting            | Support         | Support         |
| c) | Main blade          | Closed          | Closed          |
| d) | Ground blade        | Open            | Open            |
| e) | Level of testing, g | 0.75            | 1.0             |
| f) | Time history        | Landers5H       | Landers5H       |
| g) | Date                | 5/15/2003       | 5/15/2003       |

**2 Visual inspection results:**

|    |                                     |    |    |
|----|-------------------------------------|----|----|
| a) | Overall assembly for alignment      | OK | OK |
| b) | Insulators at base for cracks       | OK | OK |
| c) | Jacking bolts for deformation       | OK | OK |
| d) | Live part casting: hinge and jaw    | OK | OK |
| e) | Blade ring for impact               | OK | OK |
| f) | Motor operator fuses for continuity | OK | OK |

**3 Millivolt drop test <sup>(1)</sup>**

|    |                      |    |    |
|----|----------------------|----|----|
| a) | Before testing, mΩ   | 71 | 71 |
| b) | Before testing, mΩ   | 71 | 74 |
| c) | Resistance change, % | 0  | 4  |
| d) | Allowed, %           | 20 | 20 |

**4 Mechanical operating test <sup>(2)</sup>**

|    |                            |    |    |
|----|----------------------------|----|----|
| a) | Alignment during operation | OK | OK |
| b) | Operating functionality    | OK | OK |

**5 Main circuit continuity <sup>(3)</sup>**

|    |                        |    |    |
|----|------------------------|----|----|
| a) | Any loss of continuity | No | No |
|----|------------------------|----|----|

**6 Anomalies**

|  |   |   |
|--|---|---|
|  | (a) four 5/8 SST bolts in rear hinge loose - retightened                            | (a) stationary arc horn bent - restored                   |
|  | (b) VM-1 (motor mechanism) key bounced out of place - installed a bolt in lock ring | (b) main switch vertical pipe popped out of place - fixed |
|  | (c) adjustable arm popped out of toggle -   |   |

Note:

(1) Estimate change in resistance of the main circuit

(2) Open the main blade of the closed switch to the extent possible and return to the closed position

(3) Checked only for switch in closed position



**Fig. 5.9 Anomaly 1: stationary arc horn bent away from blade (used to be in contact with blade).**



**Before PL test**



**After PL test**

**Fig. 5.10 Anomaly 2: vertical pipe of main switch out of joint**

## **5.4 SUMMARY AND CONCLUSIONS**

### **5.4.1 RRS Enveloping and Tolerance Zone Criteria**

A comparison on the TRS with the target IEEE PL spectra anchored to 1.0g pga are shown in Figure 5.11. These plots and the zoomed versions shown in Figure 5.12 show that the TRS fell below the target IEEE PL spectra in various frequency ranges in both horizontal and vertical directions.

In general, deficiencies in the TRS for the vertical direction are not of interest when considering the seismic performance of the switch. The deficiencies in the TRS for the X and Y horizontal directions vary up to about 30% within the plateau of the IEEE PL target spectra, but only about 3 to 10% in the region close to the important resonant frequencies of the switch. The new recommended specifications for development of input motions summarized in Appendix A permit a -10% deviation in the TRS compared to the required (RRS or PL) spectra.

It is of interest to note that the TRS falls only about 3% below the required PL spectrum for the X-direction. The X-direction (transverse to the switch base) loading dominates the total demand load on the rigid insulator post, which is the most highly stressed insulator (Table 5.2).

Strictly speaking, the TRS does not satisfy the requirements of the new recommended specification because of the deviations away from the resonant frequencies of the equipment. However, because the switch behavior is dominated by the modes of vibration at 1.7 and 2.6 Hz in the X and Y directions, respectively, these deficiencies would not be expected to have a significant effect on switch performance, had they been corrected.

### **5.4.2 Qualification Testing Acceptance Criteria Related to PL Testing**

The disconnect switch preserved its major functions after the PL testing without any major damage. Some anomalies occurred during the test were insignificant. The restoration work did not involve any installation of new parts. Parts impacted out from their original positions were simply repositioned back in place, and corrective actions required to prevent their recurrence appear to be relatively simple. Therefore, the disconnect switch complied with the functional requirements for PL testing.

Although the TRS came close to satisfying the new recommended input motion specifications for IEEE 693, the rigid insulator post in the PL test was loaded to a level 37% beyond the rated cantilever strength of 2900 lbs assigned to this model of insulator by the manufacturer. Fracture of the porcelain insulator post did not occur during the PL test because

the actual strength of the installed insulator exceeded the rated cantilever strength by over 40%. This outcome highlights the conservatism associated with insulator cantilever strength ratings, which are essentially guaranteed minimum breaking strengths, as discussed previously.

One possible means of mitigating the high stresses experienced by the porcelain insulators is through the use of higher strength, lighter insulators. The insulators used in this project were extra-high creep models, which are used by utilities in coastal or high air pollution areas. Insulators with extra-high creep ratings are characterized by additional or more complex-shaped sheds, which generally add more mass to the insulator. At the time of this writing, project utility participants were in the process of implementing new procurement specifications for improved insulators to be used with 500kV switches.

The acceptance criteria of IEEE 693-1997 for equipment qualified by PL testing permits the omission of strain gages during this very challenging test. The rationale for this provision is as follows: since the PL test subjects the equipment to a loading environment representative of the highest level of shaking that it could be expected to experience, maintaining its functions without severe structural damage such as fracture, is sufficient to demonstrate qualification. The results of the PL test conducted in this project demonstrate that such a practice can lead to unconservative results when substantial overstrength or uncertainty in material strengths/capacities are involved. This is particularly true for non-ductile components such as porcelain insulators. The shortcomings of the noted provisions of IEEE 693-1997 should be considered for revision.

Nevertheless, the overall performance of the switch mounted on a 14 ft-tall support structure tested in this project was very favorable. Tests were conducted to high levels of shaking, with no failures and no significant anomalies. It should be noted that for 500kV disconnect switches, the closed position is of most interest to utilities, since switches of this voltage class are almost always in this position.

A detailed discussion of the qualification of the switch to IEEE 693-1997 will be presented in a separate report prepared by the equipment manufacturer.

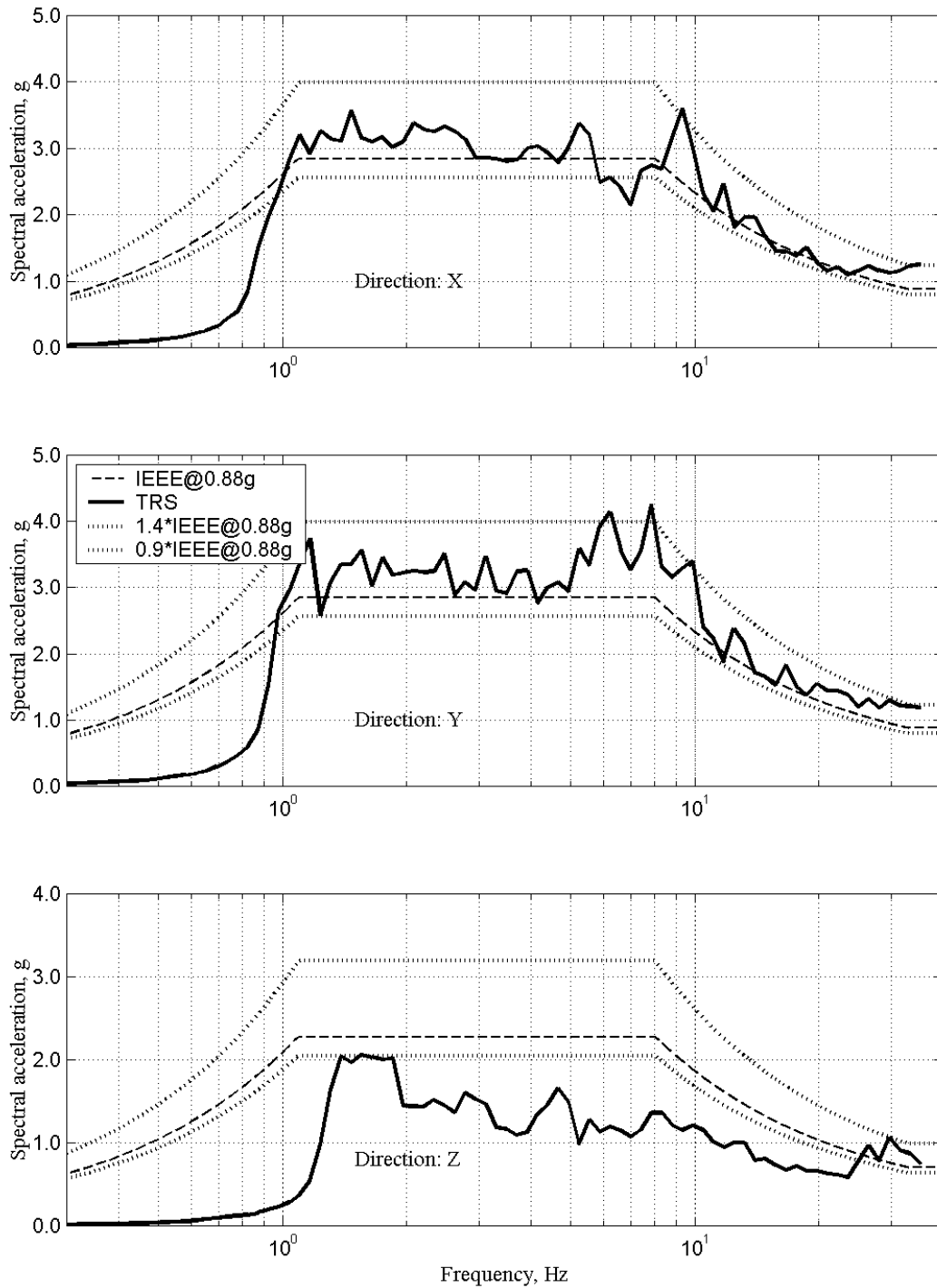


Fig. 5.11 Test response spectra plotted against high seismic PL response spectra at 0.88g.

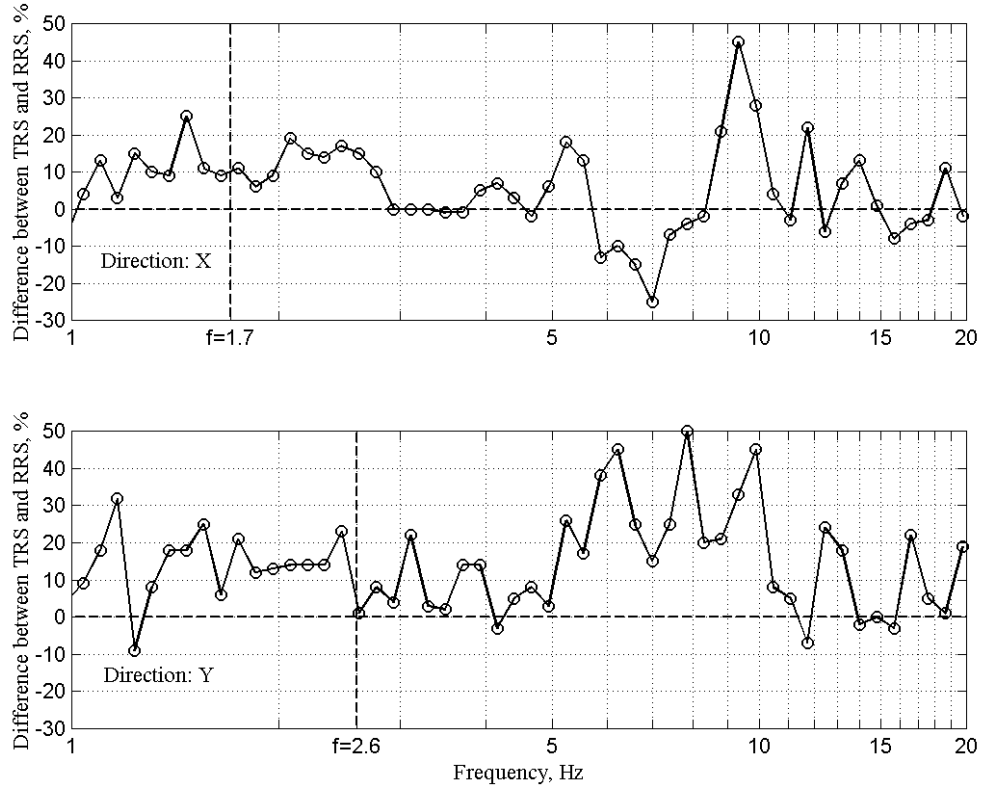


Fig. 5.12 Difference between TRS and high seismic PL spectra anchored at 0.88g.

## **6 Qualification Tests for Modified Switch in Open Position without Supports**

The chapter presents the experimental results and discussions related to the seismic qualification testing of the disconnect switch with the main contact open, that was conducted with and without tall supports. The qualification testing of the switch mounted on the supporting structure was conducted only with the main blade in the closed position because of the limited vertical clearance above the earthquake simulator platform. To qualify the disconnect switch with the main contact open, it was tested without the supports, but the input motion was scaled to represent the dynamic amplification of the supports. A switch mounted on supports, on short spacers, and rigidly attached to the table (without the supports) were tested at 0.25g target pga and were cross-compared. Based on a ratio of response parameters at the critical locations of the switch observed in these three configurations, the amplification factor was established. Finally, at the stage of qualification testing of the switch with open blade position, the switch mounted on short spacers (without 14 ft tall supports) was subjected to a time history scaled up by the amplification factor.

### **6.1 ESTIMATION OF AMPLIFICATION FACTOR**

#### **6.1.1 Configurations of Disconnect Switch with Main Blade Closed**

The experimental study on the amplification factor was conducted for three configurations of the modified switch: mounted on 14 ft tall supports, mounted on 4-in spacers, and without the supports, as defined in Chapter 2. The spacer was used to replicate the local flexibility of 1-in plate on the top of the 14 ft tall supports. To have comparable specimens, the switch in all three configurations was tested with the main blade in closed position, since the tallest configuration -- support mounted switch -- could not be tested with the main contact open.

### 6.1.2 Resonant Frequency and Damping

Table 6.1 summarizes the resonant frequency and damping of the switch in the three configurations, which were established from excitation-and-release (free-vibration) tests and random and sweep testing. As the stiffness of the system increases, the resonant frequencies in both horizontal directions steadily increase from the most flexible configuration (support mounted) to the least flexible one (switch rigidly mounted to the table). Since the resonant frequencies of all three configurations are within a frequency range covering the spectral plateau of the IEEE RRS, the data from time history testing in different configurations are assumed to be comparable.

**Table 6.1. Resonant frequency and damping of Modified Switch with closed blade.**

| Configuration                           | Direction | Resonant frequency, Hz | Damping, % |
|---|-----------|------------------------|------------|
| Support<br>(with 14 ft tall<br>columns) | X         | 1.7                    | 1.0        |
|   | Y         | 2.6                    | 1.0        |
| Spacer                                  | X         | 2.5                    | 2.0        |
|   | Y         | 3.4                    | 2.0        |
| Rigid                                   | X         | 3.0                    | 2.0        |
|   | Y         | 3.9                    | 1.0        |

### 6.1.3 Amplification Factor Based on Critical Loads Ratio

The estimate of the amplification factor due to the supports is based on negative (tension) strain data gathered during time history testing of the switch in three configurations conducted at the same target pga of 0.25g. The amplification factor was calculated from modulus ratios of the equivalent cantilever load for two pairs of configurations: support versus rigid and support versus spacer. All comparisons for amplification factor determination are made with the main contact closed. The configuration pairs used in cross-examination are shown in Fig. 6.1. The ratio is determined for each post, as summarized in Table 6.2. The ratios are quite consistent for these two comparisons: up to 1.7 for Jaw Post, 1.83 for Rotating Post, and up to 1.57 for Rigid Post. The Rigid Post, which is the most overstressed post, has the smallest amplification factor, and the least over-stressed Rotating Post has the largest amplification factor.

The differences in amplification factor computed for the three insulator posts and the distribution of forces between the three insulator posts suggests that there are differences in behavior of the switch when mounted on the 14 ft-tall supports as opposed to spacer or rigid-



support mounting. While the reasons for these differences cannot be known with certainty, they may be related to differences in dynamic response caused by the support structures, differences in behavior related to play in the rotating bearing (at the base of the rotating insulator post), or other causes.

An alternative to the amplification factors reported in Table 6.4 may be to use a more gross measure of response such as the sum of equivalent cantilever loads in the rotating and rigid insulator posts. The rationale for this approach is that it provides a measure of total inertial loading on the two hinge-end insulators, whereas the distribution of forces on individual insulators may vary with the intensity of shaking. This approach would result in amplification factors of about 1.5 and 1.66 for the spacer and rigid-mounted conditions, respectively.

For simplicity, the most conservative amplification factor of 1.83 is selected as an amplification factor for qualification testing of the switch in open position. The advantage of selecting the highest amplification factor for testing is that downward adjustments to the amplification factor can be made at a later date, after completion of testing.

**Table 6.2. Amplification factor calculation at 0.25g target pga testing based on use of negative strain.**

| Configuration | Post     | Modulus of equivalent cantilever load, lbs | Amplification factor |
|---------------|----------|--|----------------------|
| Support       | Jaw      | 1089                                       |                      |
|               | Rotating | 590  |                      |
|               | Rigid    | 1426                                       |                      |
| Spacer        | Jaw      | 672  | 1.62                 |
|               | Rotating | 322  | <b>1.83</b>          |
|               | Rigid    | 1076                                       | 1.33                 |
| Rigid         | Jaw      | 641  | 1.70                 |
|               | Rotating | 322  | <b>1.83</b>          |
|               | Rigid    | 906  | 1.57                 |



(a) Configuration without supports (rigid or spacer)

(b) Support mounted configuration

**Fig. 6.1 Two cross-examined pairs of configurations used in amplification factor estimation.**

## 6.2 SEISMIC QUALIFICATION TESTING OF DISCONNECT SWITCH IN OPEN POSITION (GROUND BLADE CLOSED)

### 6.2.1 Resonant Frequency and Damping of Spacer Mounted Switch in Open Position

The resonant frequencies and damping ratios of the spacer-mounted switch are presented in Table 6.3. The plots representing results of resonance search are shown in Appendix C (Figs.C.5-C.7)

**Table 6.3. Resonant frequency and damping of spacer-mounted Modified Switch: main blade open and ground blade closed.**

| Switch component    | Direction | Resonant frequency, Hz | Damping, % |
|---------------------|-----------|------------------------|------------|
| Jaw Post            | X         | 3.6                    | 2          |
|                     | Y         | 4.0                    | 2          |
| Blade               | X         | 1.3                    | 4          |
|                     | Y         | 1.0 <sup>(1)</sup>     | 18         |
| Rigid&Rotating Post | X         | 2.7                    | 3          |
|                     | Y         | 3.3                    | 3          |

Note:

(1) since the blade is attached to a damper (counter balance assembly) in Y direction, the resonant frequency of the blade in this direction is difficult to estimate precisely; the value presented in the table is a rough estimation.

### 6.2.2 Time History Testing of Spacer Mounted Switch in Open Position

**Severity Level Definitions for Qualification Purposes.** The time history testing was conducted at various levels that are classified by target pga of the strong motion. Because of some underperformance of the shaking table, the TRS at a particular target pga did not satisfy the IEEE 693 requirements and new recommendations (Takhirov et al, 2004) on enveloping of the IEEE spectrum anchored at the same pga. Therefore, a new term of IEEE equivalent pga (or equivalent qualification pga) is introduced in this report, for the support-mounted and spacer-mounted configurations of the disconnect switch. These equivalent pga differ by the amplification factor, taken to be 1.83. The equivalent pga (or equivalent qualification pga) of a particular time-history testing is the anchoring pga of the IEEE spectrum that is enveloped by the TRS in accordance with the IEEE 693 requirements and new recommendations (Takhirov et al, 2004). The following sections use three classifications of the intensity for qualification testing: target pga, equivalent qualification pga for spacer-mounted switch, and equivalent qualification pga for support-mounted switch. Table 6.4 shows a relationships between the target pga and the estimated equivalent qualification pga in the configurations with and without supports. These terms are further discussed in the next section.

**Table 6.4. Target and equivalent qualification pga for tests conducted on spacer-mounted switch, assuming amplification factor = 1.83.**

| No. | Target pga, g | Equivalent qualification pga, g |                               |
|-----|---------------|---------------------------------|-------------------------------|
|     |               | Spacer-mounted                  | Support-mounted <sup>1)</sup> |
| 1   | 0.5           | 0.41                            | 0.22                          |
| 2   | 0.85          | 0.69                            | 0.38                          |
| 3   | 1.0           | 0.85                            | 0.46                          |
| 4   | 1.17          | 0.92                            | 0.50                          |

Note:

1) equivalent qualification pga for support-mounted switch is a ratio of that for spacer-mounted switch to the amplification factor

**TRS at Various Target pga.** At the next stage of testing the switch was tested with the IEEE-compatible Landers time history, Landers5H, target pga from 0.5g to 1.17g pga. The test response spectra (TRS) were computed at 2% damping and based on the acceleration data record

at the rigid foundations for the switch. For each level of testing, the TRS is plotted at 1/12 octave frequency resolution and compared with the IEEE spectrum in Figs. 6.2-6.5.

Due to limitations of the earthquake simulator a number of spectral accelerations of the TRS are less than the required spectrum as much as 10%. Therefore, the last test at 1.17g target pga is compared with the IEEE spectrum anchored at 0.92g as shown in Fig. 6.6 to satisfy the enveloping criteria of IEEE 693. The TRS peaks and valleys obtained during 1.17g target pga testing are expressed as percentage of the plateau spectral acceleration for IEEE spectrum anchored at 1.17g and 0.92g and shown in Figs. 6.7-6.8. The vertical dashed lines represent the resonant frequencies of the modified switch. These plots are similar to the plots in Figs. 6.4-6.5 presenting tolerance between the TRS and the required response spectra for the frequency range from 0.3 Hz to 33 Hz, but focused only on the spectral accelerations below and above the IEEE spectra that represent possible undertesting and overtesting of the switch in frequency range from 1Hz to 20 Hz).

Since the TRS at 1.17g pga envelopes the IEEE spectrum anchored at 0.92g, the equivalent qualification pga for the spacer-mounted switch is 0.92g. Since the amplification factor is taken to be 1.83, the level is assumed to represent 0.5g equivalent qualification pga for the support-mounted switch.

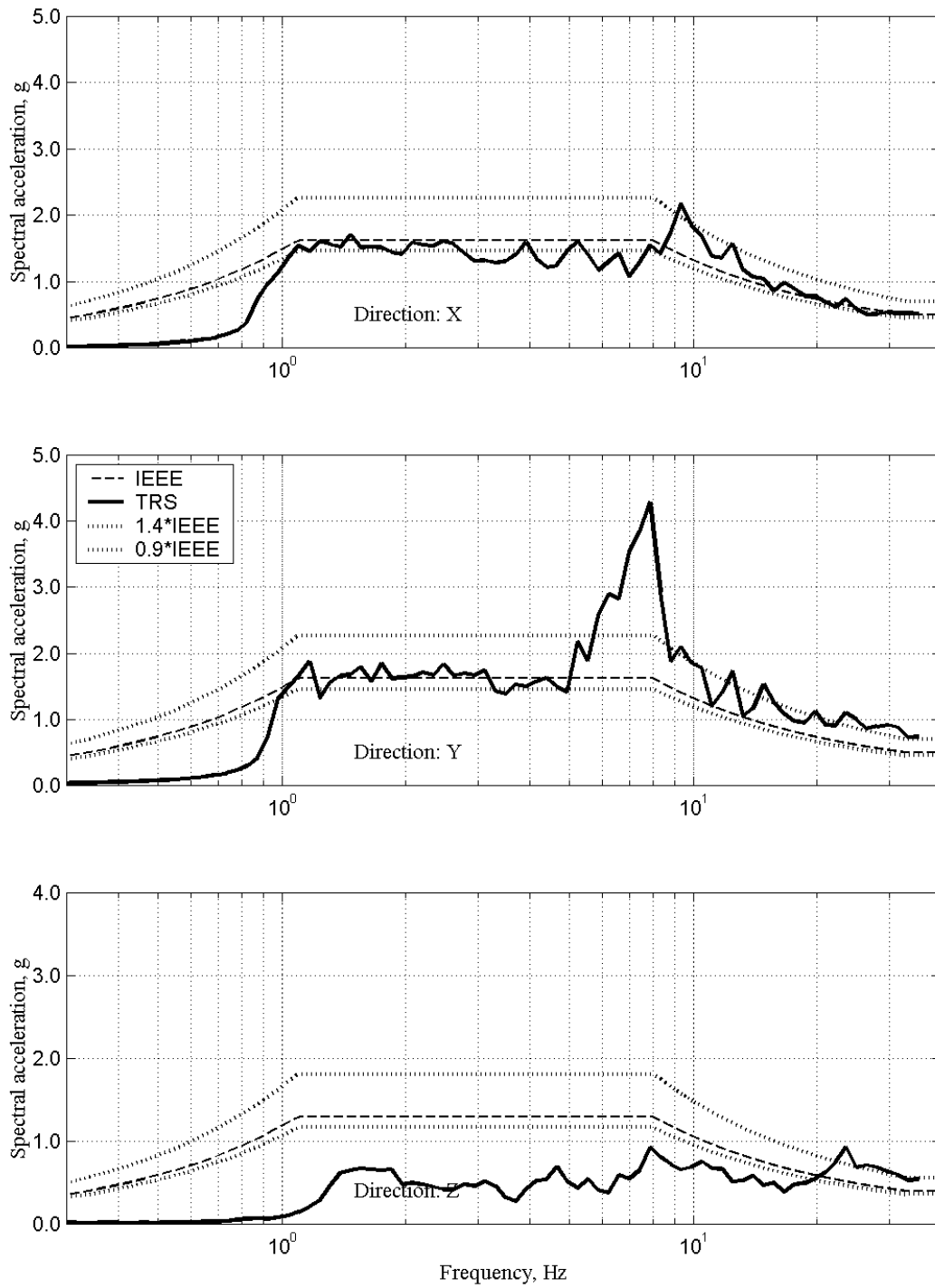


Fig. 6.2 Test response spectra of Modified Switch mounted on spacer (Landers5H at 0.5 g)

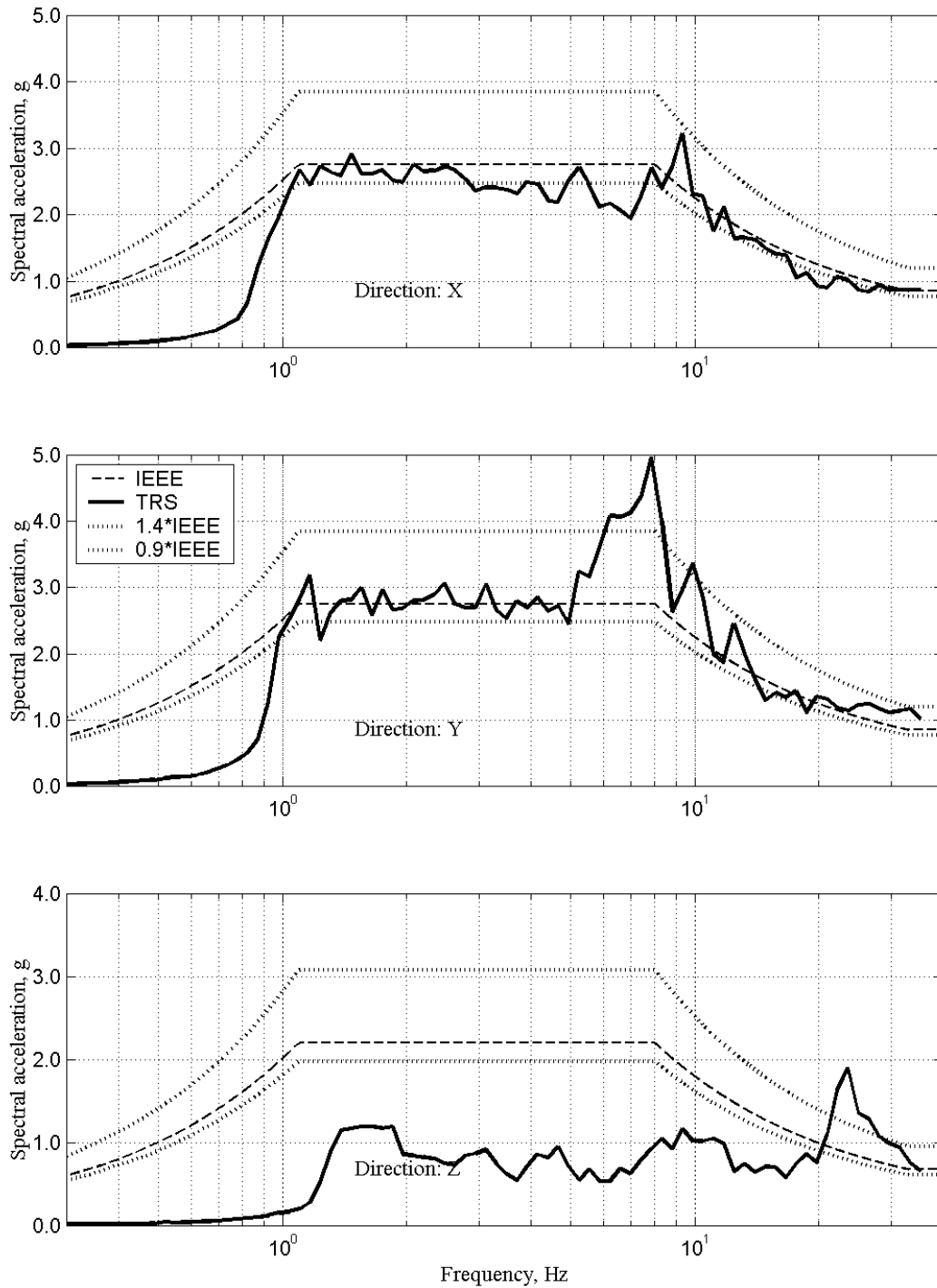


Fig. 6.3 Test response spectra of Modified Switch mounted on spacer (Landers5H at 0.85 g)

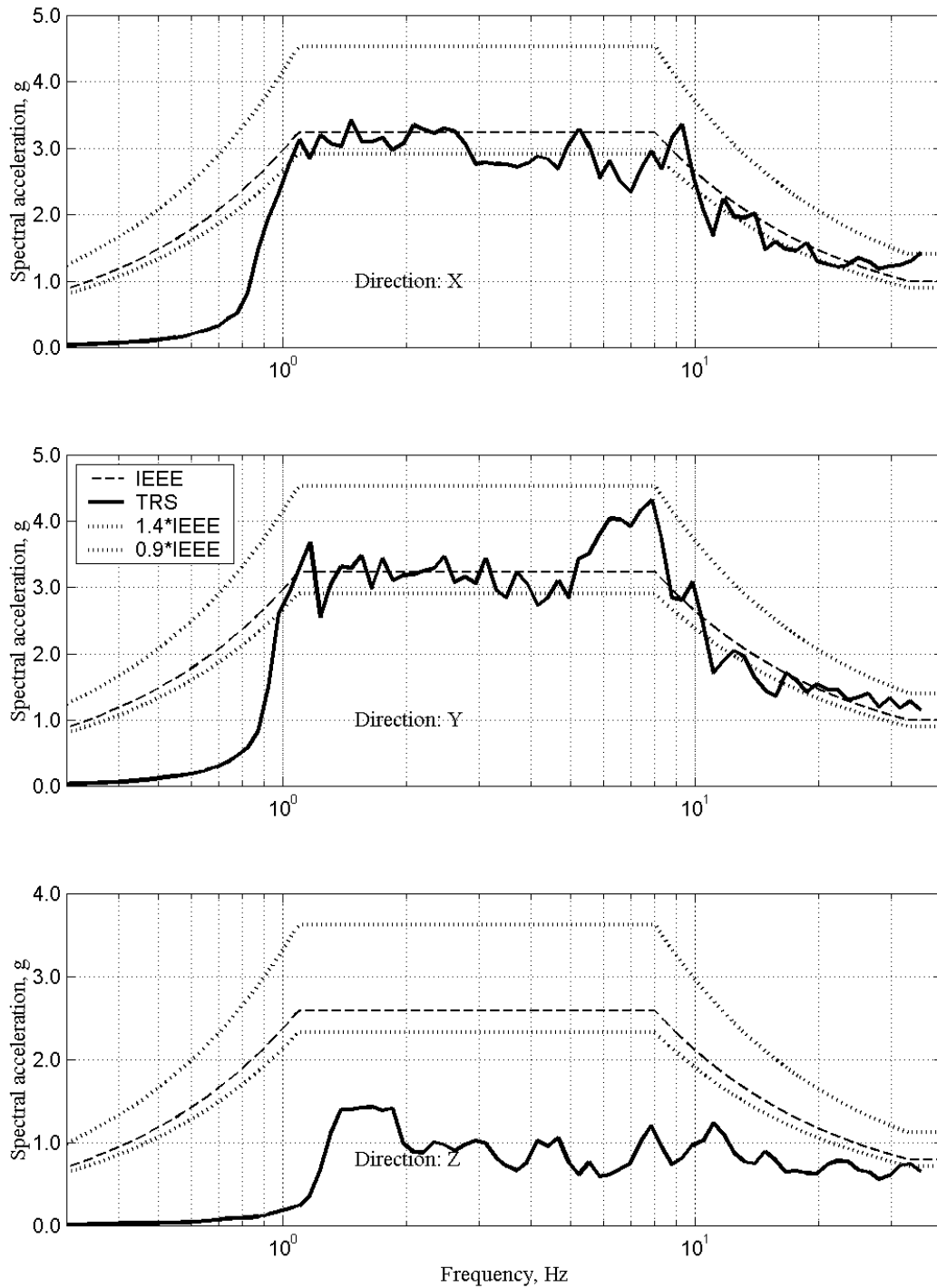


Fig. 6.4 Test response spectra of Modified Switch mounted on spacer (Landers5H at 1.0 g)

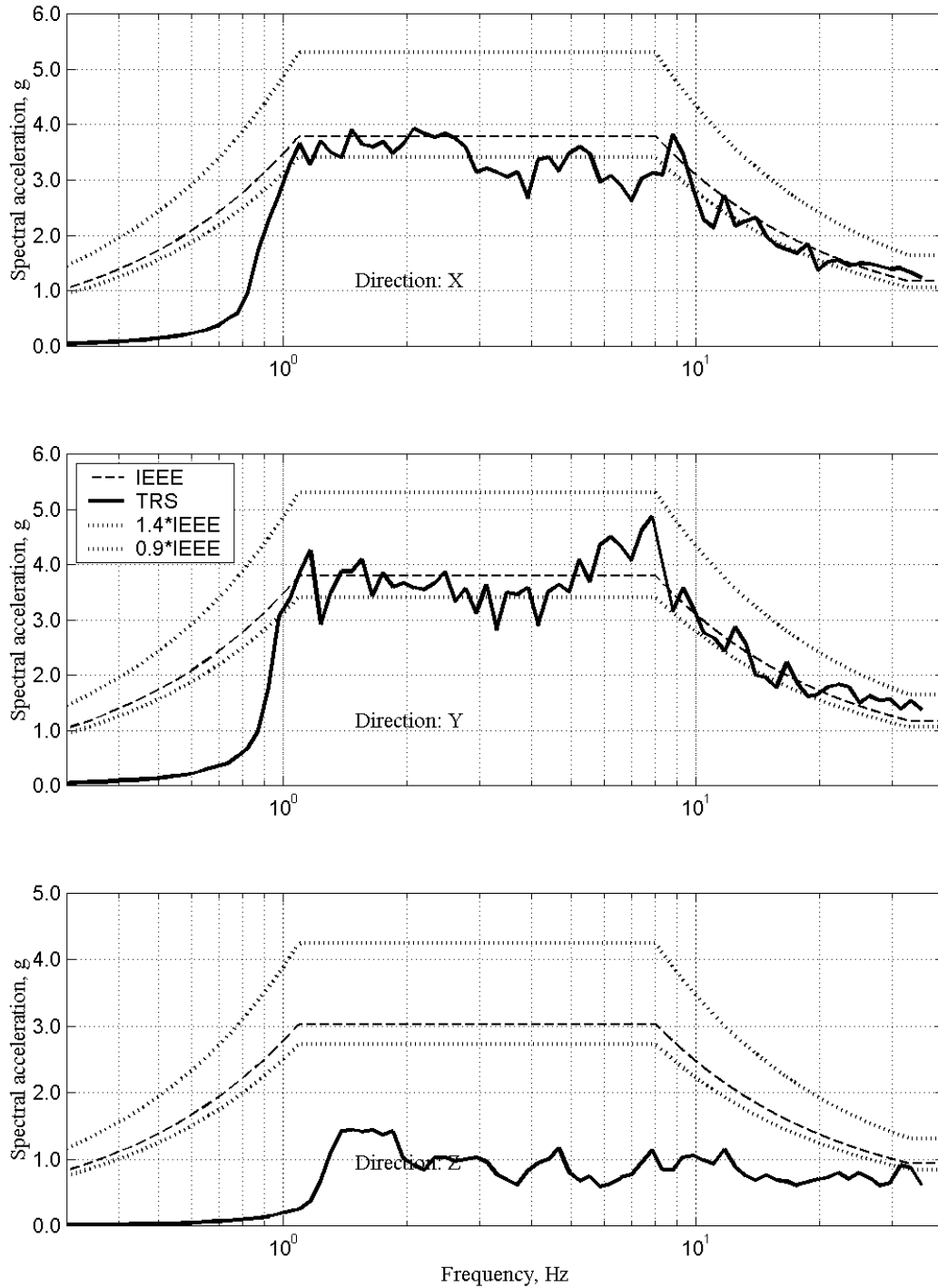


Fig. 6.5 Test response spectra of Modified Switch mounted on spacer (Landers5H at 1.17 g)



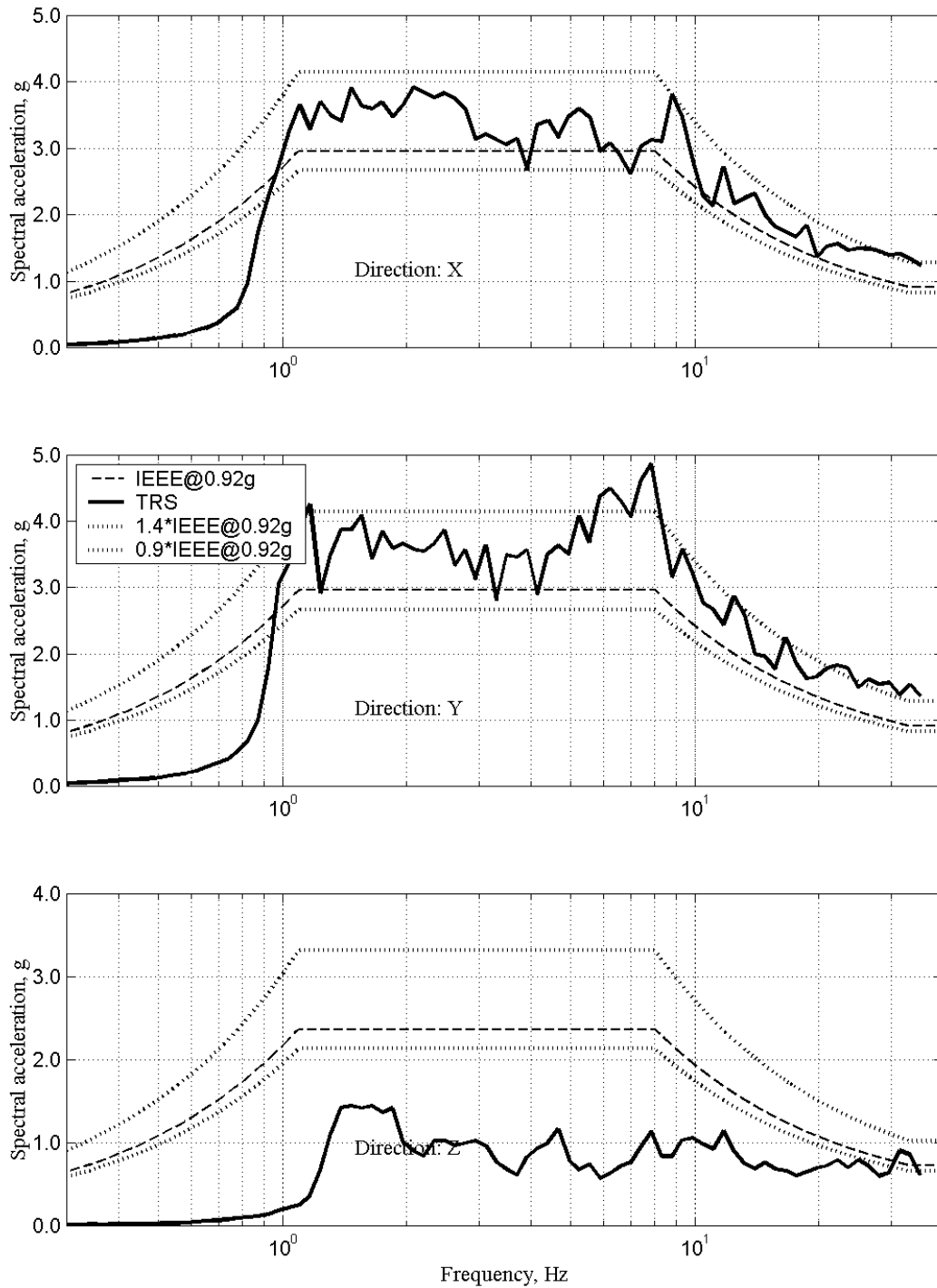
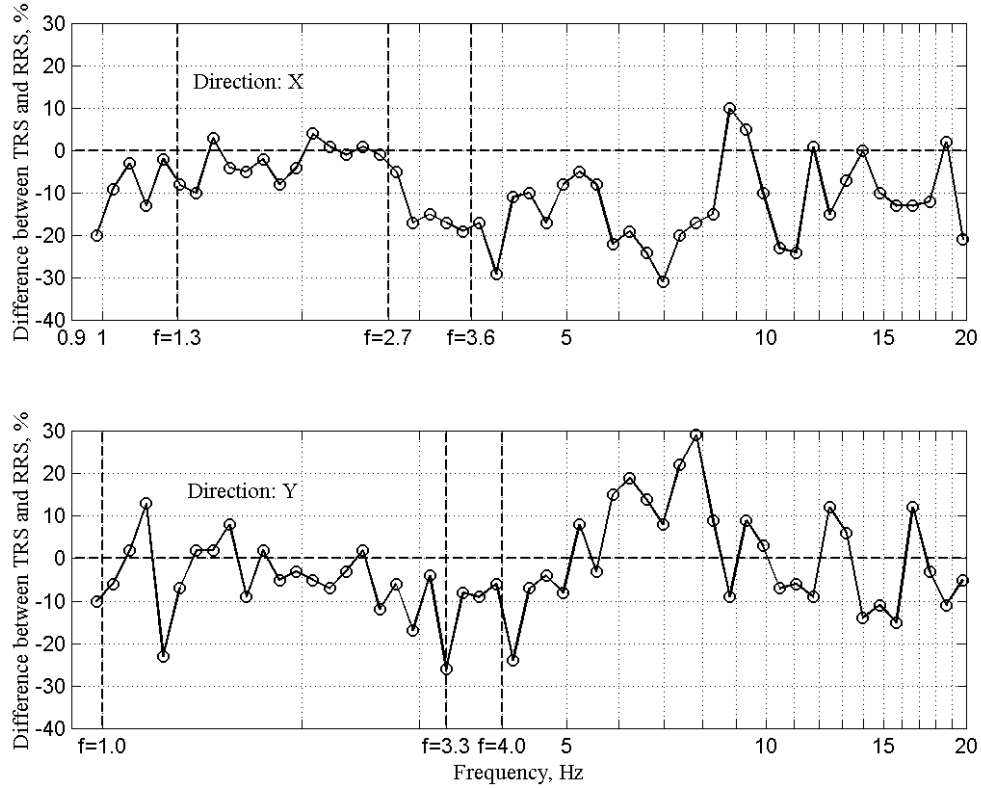
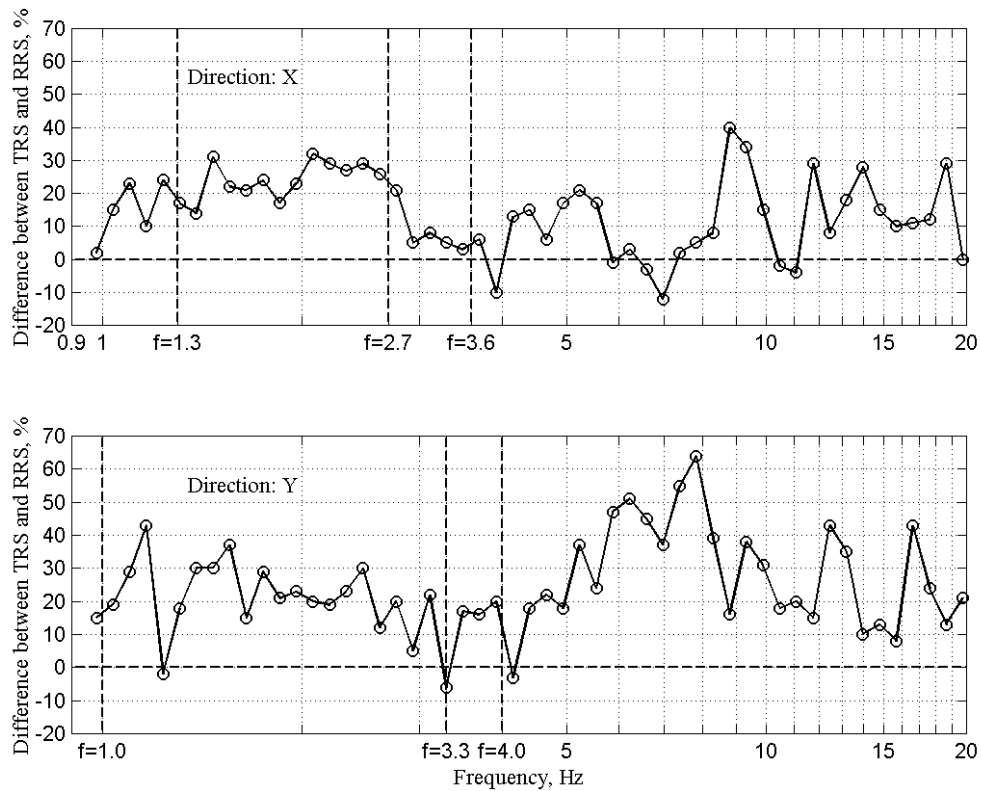


Fig. 6.6 TRS at 1.17g pga plotted against IEEE spectrum anchored at 0.92g.



**Fig. 6.7** Difference between TRS and IEEE spectra at 1.17g for Modified Switch testing at 1.17g.



**Fig. 6.8** Difference between TRS and IEEE spectra at 0.92g for Modified Switch testing at 1.17g.

**Equivalent Cantilever Load in Insulator Posts.** Table 6.5 presents the maximum of the equivalent cantilever loads and the maximum modulus of the load. The variation in the maximum equivalent cantilever load from level to level is consistent and is close to linear up to 0.5g target pga. The modulus of equivalent cantilever load is linear trend from 0.5g to 1.0g target pga testing for all three posts, although it becomes nonlinear after 1.0g target pga for the Rigid Post.

**Table 6.5. Equivalent cantilever loads at insulator posts for all target pga.**

| Target pga,<br>g | Direction | Demand load (equivalent cantilever), lbs |          |      | Demand load/ Rated Cantilever load), % |          |     |
|------------------|-----------|--|----------|------|--|----------|-----|
|                  |           | Rigid                                    | Rotating | Jaw  | Rigid                                  | Rotating | Jaw |
| 0.50             | X         | 921                                      | 420      | 774  | 32                                     | 14       | 27  |
|                  | Y         | 1308                                     | 328      | 855  | 45                                     | 11       | 29  |
|                  | Modulus   | 1308                                     | 420      | 855  | 45                                     | 14       | 29  |
| 0.85             | X         | 1450                                     | 727      | 1235 | 50                                     | 25       | 43  |
|                  | Y         | 2032                                     | 609      | 1541 | 70                                     | 21       | 53  |
|                  | Modulus   | 2032                                     | 756      | 1541 | 70                                     | 26       | 53  |
| 1.0              | X         | 1821                                     | 859      | 1428 | 63                                     | 30       | 49  |
|                  | Y         | 2241                                     | 705      | 1804 | 77                                     | 24       | 62  |
|                  | Modulus   | 2327                                     | 1012     | 1804 | 80                                     | 35       | 62  |
| 1.17             | X         | 1896                                     | 980      | 1645 | 65                                     | 34       | 57  |
|                  | Y         | 2294                                     | 831      | 1925 | 79                                     | 29       | 66  |
|                  | Modulus   | 2352                                     | 1186     | 2024 | 81                                     | 41       | 70  |

Assuming an amplification factor of 1.83, the Rigid and Jaw Posts are over-stressed at all severity levels of qualification testing except for 0.5g target pga based on the 2900 lbs equivalent cantilever load rating. Nevertheless, the switch preserved its structural integrity up to 1.17g target pga, which is downgraded to 0.92g equivalent qualification pga (spacer-mounted configuration) to comply with requirements of the new recommended input motion specification for the IEEE 693 document. Since the amplification factor is assumed to be 1.83, this equivalent pga for spacer-mounted switch corresponds to  $0.92\text{g}/1.83=0.50\text{g}$  equivalent qualification pga for the switch mounted on the supports. Performance of the switch for different values of amplification factor can be evaluated by scaling. A more detailed discussion of qualification of

the switch to IEEE 693-1997 will be provided in a separate report prepared by the equipment manufacturer.

### 6.2.3 Summary of Other Monitored Data

The maximum displacements at the top of all insulators posts are summarized in Table 6.6 and the accelerations are summarized in Table 6.7. A summary on maximum strains, stresses, and equivalent cantilever loads at the main blade is shown in Table 6.7.

**Table 6.6. Maximum displacements (relative to table) of Modified switch**

| <b>Target<br/>pga, g</b> | <b>Direction</b> | <b>Rigid Post, in</b> | <b>Rotating Post, in</b> | <b>Jaw Post, in</b> | <b>From Rotating to<br/>Jaw Posts, in</b> |
|--------------------------|------------------|-----------------------|--------------------------|---------------------|---|
| 0.5                      | X                | 2.08                  | 2.33                     | 1.43                |   |
|                          | Y                | 2.20                  | 2.20                     | 1.33                | 2.22                                      |
|                          | Modulus          | 2.47                  | 2.51                     | 1.46                |   |
| 0.85                     | X                | 3.44                  | 3.83                     | 2.32                |   |
|                          | Y                | 3.46                  | 3.46                     | 2.37                | 3.58                                      |
|                          | Modulus          | 3.97                  | 3.94                     | 2.61                |   |
| 1.0                      | X                | 4.29                  | 5.39                     | 2.69                |   |
|                          | Y                | 3.92                  | 3.92                     | 2.80                | 4.08                                      |
|                          | Modulus          | 4.90                  | 5.70                     | 3.09                |   |
| 1.17                     | X                | 4.47                  | 6.39                     | 3.08                |   |
|                          | Y                | 4.07                  | 4.07                     | 3.35                | 5.03                                      |
|                          | Modulus          | 5.06                  | 6.56                     | 3.51                |   |

**Table 6.7. Maximum accelerations (relative to table) at all elevations of Modified switch**

| Target pga, g | Direction | Table, g | West support, g | East support, g | Rigid Post, g | Rotating Post, g  | Jaw Post, g | Blade, g          |
|---------------|-----------|----------|-----------------|-----------------|---------------|-------------------|-------------|-------------------|
| 0.5           | X         | 0.21     | 1.00            | 0.94            | 1.93          | 2.05              | 2.04        | NA <sup>(2)</sup> |
|               | Y         | 0.30     | 1.45            | 1.45            | 2.41          | NA <sup>(1)</sup> | 1.85        | 3.52              |
|               | Z         | 0.12     | 0.27            | 0.28            | 0.38          | 0.85              | 0.42        | 3.86              |
|               | Modulus   |          | 1.48            | 1.45            | 2.42          | NA <sup>(1)</sup> | 2.04        | NA <sup>(2)</sup> |
| 0.85          | X         | 0.39     | 1.72            | 1.57            | 3.30          | 3.59              | 3.06        | NA <sup>(2)</sup> |
|               | Y         | 0.46     | 1.87            | 1.88            | 3.84          | NA <sup>(1)</sup> | 3.41        | NA <sup>(2)</sup> |
|               | Z         | 0.21     | 0.30            | 0.41            | 0.42          | 1.36              | 0.49        | NA <sup>(2)</sup> |
|               | Modulus   |          | 1.91            | 1.92            | 3.85          | NA <sup>(1)</sup> | 3.57        | NA <sup>(2)</sup> |
| 1.0           | X         | 0.53     | 2.18            | 1.83            | 4.09          | 4.35              | 3.70        | NA <sup>(2)</sup> |
|               | Y         | 0.60     | 2.27            | 2.28            | 4.59          | NA <sup>(1)</sup> | 3.70        | NA <sup>(2)</sup> |
|               | Z         | 0.31     | 0.34            | 0.31            | 0.54          | 1.97              | 0.46        | NA <sup>(2)</sup> |
|               | Modulus   |          | 2.36            | 2.42            | 4.67          | NA <sup>(1)</sup> | 4.12        | NA <sup>(2)</sup> |
| 1.17          | X         | 0.68     | 2.498           | 2.243           | 4.629         | 5.028             | 4.226       | NA <sup>(2)</sup> |
|               | Y         | 0.82     | 2.747           | 2.731           | 4.919         | NA <sup>(1)</sup> | 4.13        | NA <sup>(2)</sup> |
|               | Z         | 0.36     | 0.446           | 0.48            | 0.582         | 2.399             | 0.633       | NA <sup>(2)</sup> |
|               | Modulus   |          | 2.841           | 2.932           | 5.25          | NA <sup>(1)</sup> | 4.826       | NA <sup>(2)</sup> |

Notes for Table 6.7:

- 1) accelerometer in Y direction is malfunctioning,
- 2) accelerometer is out of range (accelerations are greater than 5.0g).

**Table 6.8. Strains, loads, and accelerations of blade estimated based on strain data.**

| Target pga, g | Direction | Blade strain, MS | Equivalent cantilever load <sup>(1)</sup> , lbs | Equivalent cantilever acceleration <sup>(1)</sup> , g | Tip acceleration <sup>(2)</sup> , g |
|---------------|-----------|------------------|---|---|-------------------------------------|
| 0.5           | X         | 254              | 881   | 5.9   | 6.6                                 |
|               | Y         | 134              | 467   | 3.1   | 3.5                                 |
| 0.85          | X         | 348              | 1208  | 8.1   | 9.0                                 |
|               | Y         | 225              | 783   | 5.2   | 5.9                                 |
| 1.0           | X         | 434              | 1509  | 10.1  | 11.3                                |
|               | Y         | 254              | 881   | 5.9   | 6.6                                 |
| 1.17          | X         | 486              | 1688  | 11.3  | 12.6                                |
|               | Y         | 283              | 984   | 6.6   | 7.4                                 |

Notes:

- (1) estimation of equivalent cantilever load and acceleration is based on mass less blade model with mass of the blade concentrated at center of gravity
- (2) estimation of tip acceleration is based on comparison of strains with tip accelerations at low levels of testing

#### **6.2.4 Electrical Continuity and Resistance Checks**

The low voltage continuity of the main circuit was monitored during the time history testing, and no interruptions were observed. Resistance of the main circuit was checked before and after tests at 0.85g, 1.0g and 1.17g target pga. The resistance change was within allowable of up to 20% as required by IEC 60694 (IEC, 1996). The fuses of motor operator were also checked for continuity to make sure that they were not blown during dynamic testing. Inspection of the switch's main functionality and assembly alignment was also checked and results of the inspection after tests at 0.85g, 1.0g and 1.17g target pga are documented and the last two are summarized in Table 6.9.

The switch sustained all levels of testing without major structural damage and the electrical continuity of the switch is not interrupted. The major functionality of the switch was preserved and only one minor anomaly is observed in the after-test inspection. The stationary arc horn was bent by an impact during the test, in a manner that observed for the support-mounted switch (Fig. 5.9).

**Table 6.9. Results of functionality inspection.****1 General information:**

|    |                     |                 |                 |
|----|---------------------|-----------------|-----------------|
| a) | Specimen            | Modified switch | Modified switch |
| b) | Mounting            | 4-in spacer     | 4-in spacer     |
| c) | Main blade          | Open            | Open            |
| d) | Ground blade        | Closed          | Closed          |
| e) | Level of testing, g | 1.0             | 1.17            |
| f) | Time history        | Landers5H       | Landers5H       |
| g) | Date                | 5/20/2003       | 5/20/2003       |

**2 Visual inspection results:**

|    |                                  |    |    |
|----|----------------------------------|----|----|
| a) | Overall assembly for alignment   | OK | OK |
| b) | Insulators at base for cracks    | OK | OK |
| c) | Jacking bolts for deformation    | OK | OK |
| d) | Live part casting: hinge and jaw | OK | OK |

**3 Millivolt drop test (main circuit)<sup>(1)</sup>**

|    |                            |    |    |
|----|----------------------------|----|----|
| a) | Before testing, m $\Omega$ | 76 | 89 |
| b) | After testing, m $\Omega$  | 89 | 83 |
| c) | Resistance change, %       | 17 | -7 |
| d) | Allowed, %                 | 20 | 20 |

**4 Millivolt drop test (grounding circuit)<sup>(4)</sup>**

|    |                            |     |     |
|----|----------------------------|-----|-----|
| a) | Before testing, m $\Omega$ | 185 | 185 |
| b) | After testing, m $\Omega$  | 185 | 175 |
| c) | Resistance change, %       | 0   | -5  |
| d) | Allowed, %                 | 20  | 20  |

**5 Mechanical operating test<sup>(2)</sup>**

|    |                            |    |    |
|----|----------------------------|----|----|
| a) | Alignment during operation | OK | OK |
| b) | Operating functionality    | OK | OK |

**6 Grounding circuit continuity<sup>(3)</sup>**

|    |                        |    |    |
|----|------------------------|----|----|
| a) | Any loss of continuity | No | No |
|----|------------------------|----|----|

**7 Anomalies**

|  |                              |                              |
|--|------------------------------|------------------------------|
|  | (a) stationary arc horn bent | (a) stationary arc horn bent |
|--|------------------------------|------------------------------|

Note:

- (1) Estimate change in resistance of the main circuit
- (2) Open the main blade of the closed switch to the extent possible and return to the closed position
- (3) Checked only for grounding switch in closed position
- (4) Estimate change in resistance of the grounding circuit

## **6.3 SUMMARY AND CONCLUSIONS**

### **6.3.1 RRS Enveloping and Tolerance Zone Criteria**

Since TRS of the table output at 1.17g target pga enveloped the IEEE PL spectrum anchored at 0.92g, as shown in Fig. 6.6, the equivalent seismic qualification level for the spacer-mounted switch is estimated as 0.92g. The test response spectra (Takhirov et al, 2004) envelop the IEEE PL spectrum anchored at 0.92g up to 7 Hz. As presented in Fig. 6.8, the valleys below the IEEE spectral plateau are not deeper than -10%, as recommended by the companion theoretical study (Takhirov et al, 2004) provided that at least two adjacent points are equal or higher than the required spectrum. Resonant frequencies of the disconnect switch with main blade in open position varied from 1 Hz to 4 Hz; therefore, the out-of-range value at 7 Hz in TRS of X direction is assumed acceptable.

### **6.3.2 Qualification Testing Acceptance Criterion Related to PL Testing**

The disconnect switch mounted on 4-in spacer with main blade in the open position and grounding blade in closed position preserved its major functions after the 1.17g target pga testing without major damage. Therefore, the disconnect switch complies with IEEE 693 criterion for seismic qualification at PL testing. The fact that the TRS adequately enveloped the IEEE PL spectrum at 0.92g and that the amplification factor is assumed to be 1.83 leads to the conclusion that the modified disconnect switch with main blade in open position mounted on the supporting structure is seismically qualified at the moderate PL with the IEEE spectrum anchored at 0.5g pga.

In order to qualify the switch to the High Seismic Qualification Level, allowable stresses in critical elements are reviewed. Demand to capacity ratios for porcelain insulators reported in Table 6.5 show that, at the highest level of testing, insulators are stressed to about 80% of their rated cantilever strengths. Assuming a 1.83 amplification factor, these insulator demands exceed allowables by about 60%.

The issues associated with insulator overstress, rated cantilever capacities, and possible methods for mitigating these overstresses have been previously discussed in Chapter 5. In addition, alternative interpretations of the most appropriate amplification factor are possible.

Testing of the switch on rigid and spacer-type supports conducted in this project highlight some of the difficulties related to elimination of the actual support structure. Differences in behavior of the equipment when mounted on actual supports as opposed to modified or rigid



supports, the nonlinear behavior of mechanical components, and difficulties in the selection of parameters to be used as the basis for setting amplification factors are among the challenges for qualification. The high levels of shake table output required for such tests also present an obstacle to equipment qualification testing without supports.

A detailed discussion of the qualification of the switch to IEEE 693-1997 will be presented in a separate report prepared by the equipment manufacturer.

## 7 Feasibility Study on Blade Replacement by Equivalent Mass or Shortened Blade

The chapter presents results and discussions related to the feasibility study of testing disconnect switch with an equivalent mass or a shortened blade. The issue is important for development of a seismic qualification procedure for tall electrical equipment such as the vertical break disconnect switch tested, which becomes even taller after opening of main blade. The switch with an equivalent mass replacing the main blade was tested in the support-mounted configuration and spacer-mounted configuration was used for a switch with a shortened blade. The former configuration was tested at low levels of time-history testing up to 0.5g target pga and in resonant search testing, whereas the latter configuration was subjected to resonant search tests only. The tests were conducted on the Modified Switch with the grounding blade in closed and open position.

### 7.1 TESTS WITH EQUIVALENT MASS REPLACING BLADE

#### 7.1.1 Equivalent Mass Selection

The total mass of the blade was estimated as 150 lbs with center of gravity located at 114-in from the root fixture of the blade attaching it to the switch. In order to replicate the total weight of the blade, a massive steel plate with an additional mass was directly attached to the root fixture. Therefore, after the modification the total weight of the switch mounted on the tall supports was preserved. The blade replacement by the concentrated mass had several disadvantages: first, it changed the resonant frequencies of the whole system and secondly, it failed to replicate the moment at the root fixture of the blade due elevated location of the center of gravity.

#### 7.1.2 Summary of Low Level Testing of Switch with Mass Replacing Blade

*Overall Elastic Stiffness.* A summary on overall elastic stiffness of the support-mounted switch with the dummy mass is presented in Table 7.1. Since the Rotating Post adds some

stiffness to the Rigid and Rotating posts' assembly, the overall stiffness of the assembly is slightly greater than that of the Jaw Post in both directions. The Rigid and Rotating posts' assembly is much more stiffer in Y direction compared with the stiffness in X direction. The same trend is observed for the stiffness of the Jaw Post, although the difference of the stiffnesses in two directions is less dramatic.

**Table 7.1. Overall stiffness of support-mounted Modified Switch (concentrated mass)**

| Post           | Stiffness (X), kips/in | Stiffness, kips/in |
|----------------|------------------------|--------------------|
| Rigid&Rotating | 0.37                   | 0.85               |
| Jaw            | 0.33                   | 0.55               |

**Resonant Frequency.** A summary on resonant frequency of the switch with main blade replaced by the equivalent concentrated mass is presented in Table 7.2. The natural frequencies of the switch elements appear to be within the plateau of the IEEE spectra, and vary from 1.6 Hz (for the Rigid and the Rotating Post in X direction) to 3.4 Hz (the Jaw Post in Y direction).

**Table 7.2. Resonant frequencies of support-mounted Modified Switch with concentrated mass instead of main blade.**

| Grounding blade | Post           | Frequency (X), Hz | Frequency (Y), Hz |
|-----------------|----------------|-------------------|-------------------|
| Open            | Rigid&Rotating | 1.60              | 2.6               |
|                 | Jaw            | 2.5               | 3.5               |
| Closed          | Rigid&Rotating | 1.60              | 2.6               |
|                 | Jaw            | 2.5               | 3.4               |

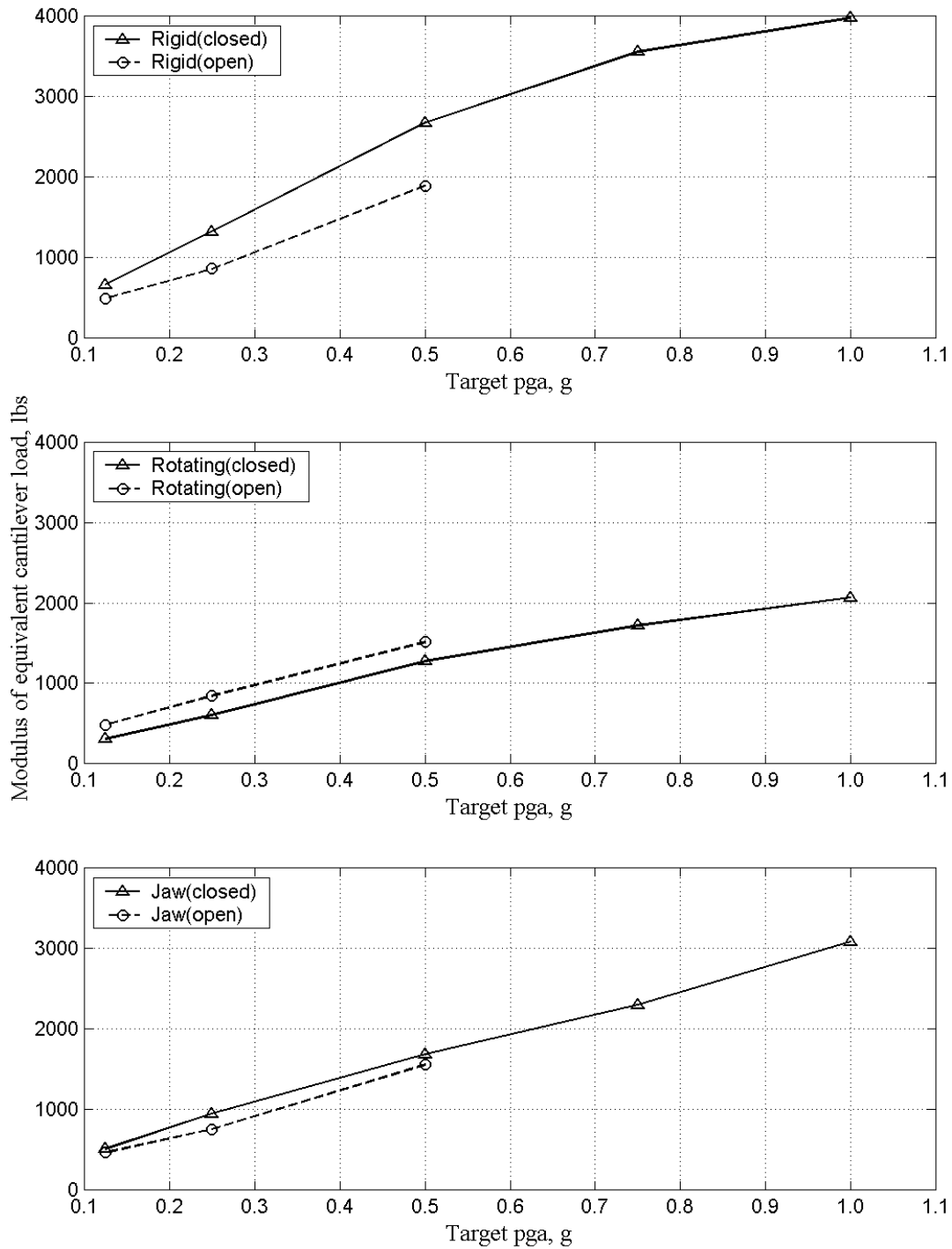
**Time-History Tests.** Time history testing was conducted by means of Landers5L (from 0.125g to 0.5g target pga) and results are summarized in Table 7.3. Comparison between the time-history tests at the various severity levels for the switch with blade closed and blade replaced by dummy mass (switch was on 14 ft tall supports in both cases) is presented in Fig. 7-1. Modulus of equivalent cantilever load in the Rigid Post is shown in the top plot of Fig. 7.1, whereas the loads in the Jaw and Rotating Posts are presented in the middle and bottom plots, respectively. The most overstressed insulator post was the Rigid Post again, with loads much greater for blade-closed position (difference for the Rigid Post is about 30%). The same

phenomenon is seen for the Jaw Post (see the bottom plot in Fig. 7.1), although there is a small difference between loads for these two switch configurations. A different conclusion is made for the Rotating Post: the loads in the post with blade's mass concentrated on its top are greater than that for the closed switch. Therefore the modulus of equivalent cantilever load becomes greater than allowable load of 1450 lbs at 0.5g target pga.

The fact that the Rigid Post – that is generally the most overstressed post – is stressed less is considered as one more supporting evidence for the conclusion that the posts in the switch-closed configuration experiences the greater loads, comparably to similar configuration with a dummy blade or with blade open.

**Table 7.3. Modulus of equivalent cantilever load for support-mounted Modified Switch with blade removed (grounding blade closed) during time-history tests by means of Landers5L.**

| No. | Target pga,<br>g | Post     | Modulus of Equivalent cantilever load,<br>lbs |
|-----|------------------|----------|---|
| 1   | 0.125            | Jaw      | 463   |
|     |                  | Rotating | 483   |
|     |                  | Rigid    | 489   |
| 2   | 0.25             | Jaw      | 755   |
|     |                  | Rotating | 839   |
|     |                  | Rigid    | 858   |
| 3   | 0.5              | Jaw      | <b>1553</b>                                   |
|     |                  | Rotating | <b>1511</b>                                   |
|     |                  | Rigid    | <b>1890</b>                                   |



**Fig. 7.1** Variation of modulus of equivalent cantilever load in blade closed and blade removed configurations.

## 7.2 TESTS WITH EQUIVALENT SHORTENED BLADE

### 7.2.1 Design of Shortened Blade

The design of the shortened blade was based on assumption that the blade can be presented as a weightless rod with a lumped mass of the blade concentrated at the center of gravity (CG). The shortened blade was required to have the same resonant frequency as the full-size blade based on the previous assumption. Therefore, the shortened blade had almost the same ratio of a total weight to a CG distance as that for the full-size blade. Figure 7.2 shows schematic representation of the full-size blade and the shortened blade. The shortened blade consists of a shortened part of the blade pipe and added masses to preserve the resonant frequency of the blade. A photo of the shortened blade installed in the switch is shown in Fig. 7.3.

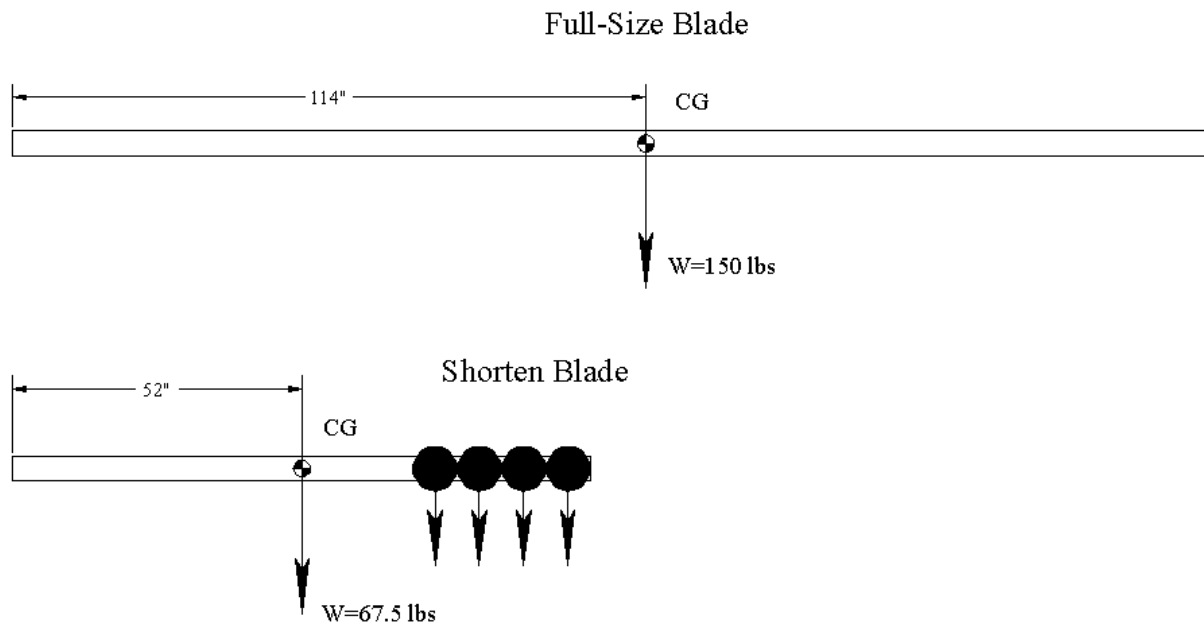


Fig. 7.2 Schematic comparison of full-size blade with shortened blade.

### 7.2.2 Resonant frequency

Resonant frequencies of the spacer-mounted switch with a shortened blade in the vertical position are compared with that of the switch with full-size blade in open position. The summary of the results is presented in Table 7.2. As expected the frequency of a stand-alone Jaw Post remains the same, whereas the frequencies of the Rigid and Rotating Posts' assembly and the

blade increases in both directions with one exception for the blade in Y direction. The increase in the resonant frequency is connected with length reduction of the blade; the increase in frequency of the shortened blade affects the whole assembly of Rigid and Rotating posts since it is attached to it.

Only random, sweep, and man excitation-and-release tests are conducted for the spacer-mounted switch with shortened blade.



**Fig. 7.3** Shortened blade installed in the switch.

**Table 7.2. Resonant frequencies of spacer-mounted Modified Switch with shortened blade and full-size blade in open position**

| Main blade       | Post           | Frequency (X), Hz | Frequency (Y), Hz  |
|------------------|----------------|-------------------|--------------------|
| Open (full-size) | Rigid&Rotating | 2.7               | 3.3                |
|                  | Jaw            | 3.6               | 4.0                |
|                  | Blade          | 1.3               | 1.0 <sup>(1)</sup> |
| Open (shortened) | Rigid&Rotating | 3.3               | 3.6                |
|                  | Jaw            | 3.6               | 4.0                |
|                  | Blade          | 1.6               | 1.0 <sup>(1)</sup> |

Note:

(1) since the blade is attached to a damper in Y direction, the resonant frequency of the blade in this direction is difficult to estimate precisely; the value presented in the table is a rough estimation.

### 7.3 SUMMARY AND CONCLUSIONS

The blade replacement by an equivalent one has at least one of two disadvantages: it changes the resonant frequencies of the whole system and/or it fails to replicate the moment at the root fixture of the blade due elevated located of the center of gravity. Therefore the experimental seismic qualification procedure has to be supported by a detailed numerical analysis for electrical equipment that would require an extensive component testing to supply the analysis with a reliable data on component properties. Therefore, the approach requires a number of equipment-specific efforts in order to achieve results that ultimately cannot be verified by the experiments. Due complexity and equipment-dependency of the approach, a simplified and universal component-replacement procedure should be the objective of a separate theoretical study supported by an experimental research.



## 8 Summary and Conclusions

The chapter provides a summary of the key findings and conclusions drawn from the research project.

### 8.1 COMPONENT TESTING

The slope in a load-strain diagram for the porcelain sections and the posts appears to depend on the sign of the strain: the tension strain develops a steeper slope than that in compression. The difference in the slope value was found to be as much as 20%. The difference in the slope may be related to material properties of the ceramic, boundary condition effects (the strain gages were installed in immediate vicinity of joints between the sections), flexibility of bolted joints, mortar between ceramic and a cap, or gap between the ceramic and the cap.

Small changes in overall stiffness and load-strain slope for the insulator posts were observed in tests before and after shake table tests. From these tests, it is concluded that: (1) the material properties of the insulator post are close to linear up to failure and (2) the violent dynamic tests have insignificantly affected the material properties of the insulators.

The elastic stiffness of insulator posts estimated during calibration tests is close to that provided by the manufacturer (NGK Insulators, Ltd.). The linear relationship between a horizontal load and a tip deflection estimated in the manufacturer's tests is confirmed in this study. The failure load is close to that observed in the tests conducted by the manufacturer for similar insulator posts.

Since the strength rating of an insulator is significantly less than the mean ultimate cantilever load, the use of PL alternative failure criteria seems to be more appropriate for switches utilizing porcelain insulators. The results of the PL testing would be more predictable if insulator manufacturers would provide statistical data (such as mean and dispersion) on breaking strengths in addition to strength rating. Strain gage data monitoring and comparison with its

ultimate value would provide valuable data for design improvements during and after qualification tests

## **8.2 SWITCH WITH ORIGINAL DESIGN**

The 550-kv disconnect switch with the original design needs reinforcement at the base of the insulator posts in order to improve its seismic performance. The modifications introduced in the so-called Modified Switch significantly improve its performance and allow it to withstand the high levels of shaking imposed in this test program.

## **8.3 QUALIFICATION TESTING OF SUPPORT MOUNTED SWITCH (BLADE CLOSED)**

The disconnect switch preserved its major functions up to the highest levels of PL testing conducted in this project, without any major damage. Some anomalies occurred during the test were insignificant and minor. The restoration work did not involve any installation of new parts: the parts impacted out from their original positions were simply repositioned back in place. Therefore, the disconnect switch complied with seismic qualification criteria for PL testing, up to the level conducted in the project. Although the TRS achieved in the test program technically does not satisfy the new recommended specification for IEEE 693 for qualification to the High Seismic PL, the deficiencies in the TRS are limited to frequency ranges not close to the important modal frequencies of the equipment.

Although the TRS came close to satisfying the new recommended input motion specifications for IEEE 693, the rigid insulator post in the PL test was loaded to a level 37% beyond the rated cantilever strength of 2900 lbs assigned to this model of insulator by the manufacturer. Fracture of the porcelain insulator post did not occur during the PL test because the actual strength of the installed insulator exceeded the rated cantilever strength by over 40%. This outcome highlights the conservatism associated with insulator cantilever strength ratings.

High stresses in the insulators may be mitigated through the use of higher strength, lighter insulators. At the time of this writing, project utility participants were in the process of implementing new procurement specifications for improved insulators to be used with 500kV switches.

The acceptance criteria of IEEE 693-1997 for equipment qualified by PL testing permits the omission of strain gages during the PL test, however, the results of this project demonstrate that such a practice can lead to unconservative results when substantial overstrength or uncertainty in material strengths/ capacities are involved. This is particularly true for non-ductile components such as porcelain insulators. The shortcomings of the noted provisions of IEEE 693-1997 should be considered for revision.

Nevertheless, the overall performance of the switch mounted on a 14 ft tall support structure tested in this project was very favorable. Tests were conducted to high levels of shaking, with no failures and no significant anomalies. It should be noted that for 500kV disconnect switches, the closed position is of most interest to utilities, since switches of this voltage class are almost always in this position.

A detailed discussion of the qualification of the switch to IEEE 693-1997 will be presented in a separate report prepared by the equipment manufacturer.

#### **8.4 QUALIFICATION TESTING OF SPACER MONTED SWITCH (MAIN CONTACT OPEN)**

The disconnect switch mounted on 4-in spacer with main blade in the open position and grounding blade in closed position preserved its major functions after the 1.17g target pga testing without major damage. Therefore, the disconnect switch complies with IEEE 693 criteria for seismic qualification at PL testing at the Moderate Seismic Qualification Level, using the new recommended input motion specifications for IEEE 693.

In order to qualify the switch to the High Seismic Qualification Level, allowable stresses in critical elements are reviewed. Demand to capacity ratios for porcelain insulators were found to exceed allowable values by about 60%, assuming that a 1.83 amplification factor is used.

Similar to the case of the switch mounted on 14 ft-tall supports, the high stresses in the insulators may be mitigated through the use of higher strength, lighter insulators. At the time of this writing, project utility participants were in the process of implementing new procurement specifications for improved insulators to be used with 500kV switches. In addition, alternative interpretations of the most appropriate amplification factor are possible.

Testing of the switch on rigid and spacer-type supports conducted in this project highlight some of the difficulties related to elimination of the actual support structure. Differences in behavior of the equipment when mounted on actual supports as opposed to modified or rigid

supports, the nonlinear behavior of mechanical components, and difficulties in the selection of parameters to be used as the basis for setting amplification factors are among the challenges for qualification. The high levels of shake table output required for such tests also present an obstacle to equipment qualification testing without supports.

A detailed discussion of the qualification of the switch to IEEE 693-1997 will be presented in a separate report prepared by the equipment manufacturer.

### **8.5 FEASIBILITY OF BLADE REPLACEMENT WITH EQUIVALENT MASS OR SHORENED BLADE**

The blade replacement by an equivalent one has at least one of two disadvantages: it changes the resonant frequencies of the whole system and/or it fails to replicate the moment at the root fixture of the blade due elevated location of the center of gravity. Therefore, the experimental seismic qualification procedure has to be supported by a detailed numerical analysis for electrical equipment that would require extensive component testing to supply the analysis with reliable data on component properties. Therefore the approach requires a number of equipment-specific efforts in order to achieve results that ultimately cannot be verified by the experiments. Due to complexity and equipment-dependency of the approach, a simplified and universal component-replacement procedure needs to be developed. This should be an objective of a separate experimental study combined with an theoretical research.

### **8.6 SUGGESTIONS FOR FUTURE WORK**

Both numerical and experimental studies should be conducted to develop a reliable procedure for estimation of the amplification factor. Such procedures or guidelines are needed in order to streamline the qualification procedure, particularly for large equipment that cannot be practically tested on their supports, and also for equipment that may be supported on several different types of support structures. In addition, the consideration of alternative methods of testing, possibly using substitute support structures which are intended to provide the same equipment response as a full-scale structure, would be valuable.

Further material studies on porcelain insulator acceptance criteria are needed. IEEE 693 acceptance criteria for qualification require a factor of safety of 2.0 and 1.0 against the “ultimate strength” of the insulator, respectively for the RRS and PL. The current practice of most

utilities, manufacturers or consulting engineers is to use the rated cantilever strength as the ultimate strength of the insulator. As highlighted in the tests conducted in this project, the rated cantilever strengths of insulators are frequently set at levels representing a guaranteed minimum breaking strength. Alternative definitions of ultimate strength should be explored for use when designing for extreme events such as a large earthquake.

Differences between the stiffness of porcelain insulators in tension and compression should be investigated further. Investigations should include further tests on multiple-section insulators, porcelain material studies and tests, and collaboration with insulator manufacturers. The differences observed in this project may be significant enough to influence the outcome of qualification tests.

## References:

1. ASTM, 1986. ASTM E1049 - 85. (Reapproved 1997) *Standard Practices for Cycle Counting in Fatigue Analysis*. American Society for Testing and Materials, Annual Book of ASTM Standards, Section 3: Metals Test Methods and Analytical Procedures, Vol. 03.01-Metals-Mechanical Testing; Elevated and Low-Temperature Tests, ASTM, Philadelphia, 1986, pp. 836-848.
2. Callister, William D. 2003. *Materials Science and Engineering: An Introduction*. New York, NY : John Wiley & Sons.
3. Chopra A.K. *Dynamics of Structures: Theory and Applications to Earthquake Engineering*. Prentice Hall: Englewood Cliffs, New Jersey.
4. Downing, S.D., and Socie D.F., *Simplified Rainflow Counting Algorithms*, Int. J. Fatigue, Vol. 4, No. 1, 1982, pp. 31-40.
5. Gilani A.S.J., Chavez J.W, Fenves G.L. and Whittaker A.S. 1998. *Seismic Evaluation of 196-kV Porcelain Transformer Bushings*. Pacific Earthquake Engineering Research Center report 1998/14. PEER, University of California at Berkeley.
6. Gilani A.S.J., Whittaker A.S., and Fenves G.L. 1999. *Seismic Evaluation and Retrofit of 230-kV Porcelain Transformer Bushings*. Pacific Earthquake Engineering Research Center report 1999/14. PEER, University of California at Berkeley.
7. Gilani A.S.J., Whittaker A.S., Fenves G.L., Chen C-H., Ho H. and Fujisaki E. 2000. *Seismic Evaluation and Analysis of 230-kV Disconnect Switches*. Pacific Earthquake Engineering Research Center, Report 2000/06. PEER, University of California at Berkeley.

8. Gundy W.E. & Associates. 2002. *Design and Analysis of a Disconnect Switch Support Structure*. Report 1195-17 for Southern States, Inc. W.E.Gundy and Associates, Inc.: Hailey, ID.
9. IEEE, 1998. IEEE Standard 693-1997. 1997. *Recommended Practices for Seismic Design of Substations*. Piscataway, N.J.: IEEE Standards Department.
10. IEC, 1996. IEC 60694. *Common Specifications for High-Voltage Switchgear and Controlgear Standards*. International Electrotechnical Commission, Geneva, Switzerland.
11. IEC, 2001. IEC 60168. *Tests on Indoor and Outdoor Post Insulators of Ceramic Material or Glass for Systems with Nominal Voltages Greater Than 1000V*. International Electrotechnical Commission, Geneva, Switzerland.
12. Kennedy, R.P. 2004. Personal communication with Anshel Schiff regarding development of input motion requirements for the Nuclear Regulatory Commission, RPK Structural Mechanics Consulting.
13. Thornberry, L. R. and Hardy, R. 1997. *Seismic simulation test program on type CGCB-G 230kV disconnect switch*. Report No. 45998-1 Huntsville, Ala.: Wyle Laboratories.
14. Wyle Laboratories, 1993. *Wyle Laboratories' Seismic Test Report No. 47072-2 (Revision 2)*. Huntsville, Alabama: Wyle Laboratories Scientific Services and Systems Group.
15. Takhirov, S., Fenves, G., Fujisaki, E. and Clyde, D. *Ground Motions for Earthquake Simulator Qualification of Electrical Substation Equipment*. Pacific Earthquake Engineering Research Center, Report 2004/xx. PEER, University of California at Berkeley (to be published).
16. Schiff, A. (editor), 1999. *Manual No. 96, Guide to Improved Earthquake Performance of Electric Power Systems*, American Society of Civil Engineers, Electric Power and Communications Committee, Technical Council on Lifeline Earthquake Engineering.

## Appendix A      **IEEE 693 Specifications and New Recommendations for Seismic Qualification Testing**

The equipment and supporting structure shall be subjected to at least one time history test. The input motion time history shall satisfy the requirements given below. The Recommended Practice (IEEE, 1998) principally uses response spectra to establish the characteristics of the time histories used to seismically qualify substation equipment. When taken alone, it is an imprecise method of specifying excitation motions. A time history may be such that its response spectrum envelopes the RRS but the energy content in certain frequency ranges will be low, so that equipment that have important natural frequencies in that range may not be adequately excited. This can be the result of the design of the time history or due to the interaction of the equipment and the shake-table that is exciting it. There is a need to balance the concern that the equipment be adequately excited, with the desire to avoid over testing equipment during its qualification. While imposing a power spectral density requirement on the input time history can assure an acceptable distribution of energy over the frequency range of interest, this has proved problematic in attempting to address this issue (Kennedy, 2004). If the response spectrum of a time history is reasonably smooth, a reasonable distribution of the energy in the record is also assured (Kennedy, 2004). To avoid over testing, the TRS is permitted to dip slightly below the RRS, with appropriate limitations. All of the table motions cited below refer to accelerations or signals that ultimately will be evaluated as accelerations

***Spectral Matching.*** The theoretical response spectrum developed for testing shall envelope the RRS according to the requirements of this section. When the high seismic level is specified, the RRS shown in Figure A.1 from Appendix A of IEEE 693 (IEEE, 1998) shall be used. When the moderate seismic level is specified, the RRS shown in Figure A.2 from Appendix A of IEEE 693 (IEEE, 1998) shall be used.



The theoretical response spectrum for testing shall be computed at 2% damping, at the resolution stated, and shall include the lower corner point frequency of the RRS (1.1 Hz), for comparison to the RRS.

**Duration.** The input motion shall have a duration of at least 20 seconds of strong motion. Ring down time or acceleration ramp up time shall not be included in the 20 seconds of strong motion. The duration of strong motion shall be defined as the time interval between when the plot of the time history reaches 25% of the maximum value to the time when it falls for the last time to 25% of the maximum value.

**Theoretical Input Motion.** The spectrum matching procedure shall be conducted at 1/24 octave resolution or higher, and result in a theoretical response spectrum that is within  $\pm 10\%$  of the RRS at 2% damping.

**Filtering Limits.** The theoretical input motion record used for testing may be high-pass filtered at frequencies less than or equal to 70% of the lowest frequency of the test article, but not higher than 2 Hz. The lowest frequency of the test article shall be established by test.

**Filtered Theoretical Input Motion to Table.** The response spectrum of the filtered table input motion shall envelope the RRS within a  $-5\%/ +30\%$  tolerance band at 1/12 octave resolution or higher. A  $-5\%$  deviation is allowed at a given point, provided that the spectrum of the filtered table input motion at 2 or more adjacent points meet or exceed the RRS, and not more than a total of 5 points fall below the RRS at the stated resolution. Exceedance of the  $+30\%$  tolerance limit is acceptable with concurrence of the equipment manufacturer. Exceedances of the stated upper tolerance limit at frequencies above 20 Hz are generally not of interest, and should be accepted, unless resonant frequencies are identified in that range.

The filtered input motion to the table shall include at least 2 and a maximum of about 25 high amplitude cycles of a single-degree of freedom (SDOF) oscillator response at 2% damping. A “high amplitude cycle” is a cycle defined by ASTM E1049 (ASTM, 1997; Downing, 1982), that consists of two positive or negative peaks of the same range with a peak of opposite sign between them, having an amplitude greater than or equal to 70% of the maximum response of the SDOF oscillator. SDOF oscillators in the frequency range from 0.78 to 11.78 Hz shall be included, and oscillator frequencies shall be selected with 1/12 octave band resolution. The minimum number of high amplitude cycles is permitted to drop to 1 at no more than 5 frequency points in the specified frequency range. The number of high amplitude cycles may exceed the stated maximum value with concurrence of the equipment manufacturer. Procedures for

computing the number of high-amplitude cycles are available at the IEEE web page. A detailed explanation of this requirement is given in the companion report (Takhirov, et al, 2004).

The strong part ratio of the table input motion record shall be at least 30%. The “strong part ratio” of a given record is defined as the ratio of the time required to accumulate from 25% to 75% of the total cumulative energy of the record, to the time required to accumulate from 5% to 95% of the total cumulative energy of the record.

Where:

$$\text{Cumulative Energy} = \int a(\tau)^2 d\tau$$

$a(\tau)$  = acceleration time history

**Table Output Motion.** The table output TRS shall envelope the RRS within a –10%/+40% tolerance band at 1/12 octave resolution or higher. A –10% deviation is allowed at a given point, provided that the TRS at 2 or more adjacent points meet or exceed the RRS, and not more than a total of 5 points fall below the RRS at the stated resolution. Overtesting that exceeds the +40% limit is acceptable with concurrence of the equipment manufacturer. Exceedances of the stated upper tolerance limit at frequencies above 20 Hz are generally not of interest, and should be accepted, unless resonant frequencies are identified in that range.

## Appendix B Complete List of All Test Steps Performed

**Table B.1. List of all tests performed from 03/25/2003 to 05/28/2003.**

### Full-Length Supports' Calibration: 03/25/2003

|   | File Name    | Signal name\Test                    | Strain gages | Gage Location    |
|---|--------------|-------------------------------------|--------------|------------------|
| 1 | 030325092908 | Pullback test in Y direction@300lbs | 5-8          | West 14' Support |
| 2 | 030325111853 | Pullback test in X direction@300lbs | 5-8          | West 14' Support |
| 3 | 030325140725 | Pullback test in Y direction@300lbs | 1-4          | East 14' Support |
| 4 | 030325142832 | Pullback test in X direction@300lbs | 1-4          | East 14' Support |

### Insulator Posts' Calibration: 03/31/2003 and 04/01/2003

|    | File Name    | Signal name\Test                    | Strain gages       | Gage Location             |
|----|--------------|-------------------------------------|--------------------|---------------------------|
| 5  | 030331105124 | Stiffness and Gage Calibration in X | 13-16              | Rotating Post             |
| 6  | 030331120748 | Stiffness and Gage Calibration in Y | 13-16              | Rotating Post             |
| 7  | 030331150436 | Stiffness and Gage Calibration in X | 25-28              | Middle unit of Rigid Post |
| 8  | 030331154004 | Stiffness and Gage Calibration in Y | 25-28              | Middle unit of Rigid Post |
| 9  | 030331165623 | Stiffness and Gage Calibration in X | 29-34              | Top unit of Rigid Post    |
| 10 | 030331171107 | Stiffness and Gage Calibration in Y | 29-34              | Top unit of Rigid Post    |
| 11 | 030401101557 | Stiffness and Gage Calibration in X | 9-12, 25-28, 29-34 | Rigid Post                |
| 12 | 030401111157 | Stiffness and Gage Calibration in Y | 9-12, 25-28, 29-34 | Rigid Post                |

**Table B.1. List of all tests performed from 03/25/2003 to 05/28/2003 (continued).**

|    | File Name    | Signal name\Test                    | Strain gages | Gage Location |
|----|--------------|-------------------------------------|--------------|---------------|
| 13 | 030401135335 | Stiffness and Gage Calibration in X | 17-20, 21-24 | Jaw Post      |
| 14 | 030401141308 | Stiffness and Gage Calibration in Y | 17-20, 21-24 | Jaw Post      |

**Static Pull-Back and Free Vibration Tests for Original Switch: 04/07/2003**

|    | File Name    | Signal name\Test                    | Switch Design | Mounting    | Main Blade | Ground Switch |
|----|--------------|-------------------------------------|---------------|-------------|------------|---------------|
| 15 | 030407141830 | Pullback test in X direction@500lbs | Original      | 14' Support | Closed     | Open          |
| 16 | 030408085222 | Pullback test in Y direction@500lbs | Original      | 14' Support | Closed     | Open          |
| 17 | 030407143653 | Man excitation in X direction       | Original      | 14' Support | Closed     | Open          |
| 18 | 030407145351 | Man excitation in Y direction       | Original      | 14' Support | Closed     | Open          |

**Dynamic Tests of Original Switch on 14' Supports; Blade closed: 04/09/2003**

|    | File Name    | Signal name\Test       | Switch Design | Mounting    | Main Blade | Ground Switch |
|----|--------------|------------------------|---------------|-------------|------------|---------------|
| 19 | 030409132831 | Random in X direction  | Original      | 14' Support | Closed     | Open          |
| 20 | 030409133836 | Random in Y direction  | Original      | 14' Support | Closed     | Open          |
| 21 | 030409134232 | Random in Z direction  | Original      | 14' Support | Closed     | Open          |
| 22 | 030409135109 | Sweep24 in X direction | Original      | 14' Support | Closed     | Open          |
| 23 | 030409140346 | Sweep24 in Y direction | Original      | 14' Support | Closed     | Open          |
| 24 | 030409140941 | Sweep24 in Z direction | Original      | 14' Support | Closed     | Open          |
| 25 | 030409142115 | Landers5L@0.125g       | Original      | 14' Support | Closed     | Open          |
| 26 | 030409144826 | Landers5L@0.25g        | Original      | 14' Support | Closed     | Open          |
| 27 | 030409155007 | CERL@0.25g             | Original      | 14' Support | Closed     | Open          |

**Free Vibration Tests for Modified Switch Rigidly Mounted; Blade closed: 04/15/2003**

|    | File Name    | Signal name\Test              | Switch Design | Mounting | Main Blade | Ground Switch |
|----|--------------|-------------------------------|---------------|----------|------------|---------------|
| 28 | 030415150345 | Man excitation in X direction | Modified      | Rigid    | Closed     | Open          |

**Table B.1. List of all tests performed from 03/25/2003 to 05/28/2003 (continued).**

|    | File Name    | Signal name\Test              | Strain gages | Gage Location |        |      |
|----|--------------|-------------------------------|--------------|---------------|--------|------|
| 29 | 030415152334 | Man excitation in Y direction | Modified     | Rigid         | Closed | Open |

**Free Vibration Tests for Modified Switch Rigidly Mounted; Blade open: 04/15/2003**

|    | File Name    | Signal name\Test                     | Switch Design | Mounting | Main Blade | Ground Switch |
|----|--------------|--------------------------------------|---------------|----------|------------|---------------|
| 30 | 030415153805 | Man excitation in Y (Jaw)            | Modified      | Rigid    | Open       | Open          |
| 31 | 030415153938 | Man excitation in X (Jaw)            | Modified      | Rigid    | Open       | Open          |
| 32 | 030415155025 | Man excitation in X (Rigid&Rotating) | Modified      | Rigid    | Open       | Open          |
| 33 | 030415155231 | Man excitation in Y (Rigid&Rotating) | Modified      | Rigid    | Open       | Open          |

**Dynamic Tests of Modified Switch Rigidly Mounted to Table; Blade closed: 04/16/2003**

|    | File Name    | Signal name\Test                      | Switch Design | Mounting | Main Blade | Ground Switch |
|----|--------------|---------------------------------------|---------------|----------|------------|---------------|
| 34 | 030416124631 | Random in X direction                 | Modified      | Rigid    | Closed     | Open          |
| 35 | 030416123616 | Random in Y direction                 | Modified      | Rigid    | Closed     | Open          |
| 36 | 030416130719 | Random in Z direction                 | Modified      | Rigid    | Closed     | Open          |
| 37 | 030416131927 | Sweep24 in X direction                | Modified      | Rigid    | Closed     | Open          |
| 38 | 030416133220 | Sweep24 in Y direction                | Modified      | Rigid    | Closed     | Open          |
| 39 | 030416134339 | Sweep24 in Z direction                | Modified      | Rigid    | Closed     | Open          |
| 40 | 030416135700 | Amplified Landers5L@0.25g; scale 1/4  | Modified      | Rigid    | Closed     | Open          |
| 41 | 030416144312 | Amplified Landers5L@0.25g; full scale | Modified      | Rigid    | Closed     | Open          |
| 42 | 030416151618 | Amplified Landers5L@0.25g; scale 2    | Modified      | Rigid    | Closed     | Open          |

**Dynamic Tests of Modified Switch Rigidly Mounted to Table; Blade open: 04/16/2003**

|    | File Name    | Signal name\Test       | Switch Design | Mounting | Main Blade | Ground Switch |
|----|--------------|------------------------|---------------|----------|------------|---------------|
| 43 | 030416165053 | Sweep24 in X direction | Modified      | Rigid    | Open       | Open          |
| 44 | 030416164723 | Sweep24 in Y direction | Modified      | Rigid    | Open       | Open          |

**Table B.1. List of all tests performed from 03/25/2003 to 05/28/2003 (continued).**

|    | <b>File Name</b> | <b>Signal name\Test</b>              | <b>Strain gages</b> | <b>Gage Location</b> |      |      |
|----|------------------|--------------------------------------|---------------------|----------------------|------|------|
| 45 | 030416165355     | Sweep24 in Z direction               | Modified            | Rigid                | Open | Open |
| 46 | 030416171831     | Amplified Landers5L@0.25g; scale 1/4 | Modified            | Rigid                | Open | Open |

**Tests of Modified Switch Rigidly Mounted to Table; Blade open: 04/18/2003**

|    | <b>File Name</b> | <b>Signal name\Test</b>     | <b>Switch Design</b> | <b>Mounting</b> | <b>Main Blade</b> | <b>Ground Switch</b> |
|----|------------------|-----------------------------|----------------------|-----------------|-------------------|----------------------|
| 47 | 030419134039     | Man excitation in X (Blade) | Modified             | Rigid           | Open              | Open                 |
| 48 | 030419134736     | Man excitation in Y (Blade) | Modified             | Rigid           | Open              | Open                 |
| 49 | 030419142759     | Landers5L@0.125g            | Modified             | Rigid           | Open              | Open                 |

**Dynamic Tests of Modified Rigidly Mounted to Table; Blade closed: 04/18/2003**

|    | <b>File Name</b> | <b>Signal name\Test</b> | <b>Switch Design</b> | <b>Mounting</b> | <b>Main Blade</b> | <b>Ground Switch</b> |
|----|------------------|-------------------------|----------------------|-----------------|-------------------|----------------------|
| 50 | 030419150732     | Landers5L@0.25g         | Modified             | Rigid           | Closed            | Open                 |

**Free Vibration Tests of Modified Switch Mounted on 4" Spacer; Blade closed: 04/24/2003**

|    | <b>File Name</b> | <b>Signal name\Test</b> | <b>Switch Design</b> | <b>Mounting</b> | <b>Shorten Blade</b> | <b>Ground Switch</b> |
|----|------------------|-------------------------|----------------------|-----------------|----------------------|----------------------|
| 51 | 030424141957     | Man excitation in X     | Modified             | 4" spacer       | Closed               | Open                 |
| 52 | 030424143341     | Man excitation in Y     | Modified             | 4" spacer       | Closed               | Open                 |

**Dynamic Tests of Modified Switch Mounted on 4" Spacer; Blade closed: 04/24/2003**

|    | <b>File Name</b> | <b>Signal name\Test</b> | <b>Switch Design</b> | <b>Mounting</b> | <b>Main Blade</b> | <b>Ground Switch</b> |
|----|------------------|-------------------------|----------------------|-----------------|-------------------|----------------------|
| 53 | 030424154239     | Random in X direction   | Modified             | 4" spacer       | Closed            | Open                 |
| 54 | 030424154411     | Random in Y direction   | Modified             | 4" spacer       | Closed            | Open                 |
| 55 | 030424154521     | Random in Z direction   | Modified             | 4" spacer       | Closed            | Open                 |
| 56 | 030424154951     | Sweep24 in X direction  | Modified             | 4" spacer       | Closed            | Open                 |
| 57 | 030424155249     | Sweep24 in Y direction  | Modified             | 4" spacer       | Closed            | Open                 |

**Table B.1. List of all tests performed from 03/25/2003 to 05/28/2003 (continued).**

|    | <b>File Name</b> | <b>Signal name\Test</b>               | <b>Strain gages</b> | <b>Gage Location</b> |        |      |
|----|------------------|---------------------------------------|---------------------|----------------------|--------|------|
| 58 | 030424155628     | Sweep24 in Z direction                | Modified            | 4" spacer            | Closed | Open |
| 59 | 030424160518     | Amplified Landers5L@0.25g; full scale | Modified            | 4" spacer            | Closed | Open |
| 60 | 030424161120     | Landers5L@0.25g                       | Modified            | 4" spacer            | Closed | Open |

**Free Vibration Tests of Modified Switch Mounted on 4" Spacer; Blade open: 04/24/2003**

|    | <b>File Name</b> | <b>Signal name\Test</b>              | <b>Switch Design</b> | <b>Mounting</b> | <b>Main Blade</b> | <b>Ground Switch</b> |
|----|------------------|--------------------------------------|----------------------|-----------------|-------------------|----------------------|
| 61 | 030424144012     | Man excitation in Y (Jaw)            | Modified             | 4" spacer       | Open              | Open                 |
| 62 | 030424144145     | Man excitation in X (Jaw)            | Modified             | 4" spacer       | Open              | Open                 |
| 63 | 030424144437     | Man excitation in X (Rigid&Rotating) | Modified             | 4" spacer       | Open              | Open                 |
| 64 | 030424144604     | Man excitation in Y (Rigid&Rotating) | Modified             | 4" spacer       | Open              | Open                 |
| 65 | 030424145339     | Man excitation in Y (Blade)          | Modified             | 4" spacer       | Open              | Open                 |
| 66 | 030424145459     | Man excitation in X (Blade)          | Modified             | 4" spacer       | Open              | Open                 |

**Free Vibration Tests of Modified Switch Mounted on 4" Spacer; Shorten blade open: 04/25/2003**

|    | <b>File Name</b> | <b>Signal name\Test</b>              | <b>Switch Design</b> | <b>Mounting</b> | <b>Shorten Blade</b> | <b>Ground Switch</b> |
|----|------------------|--------------------------------------|----------------------|-----------------|----------------------|----------------------|
| 67 | 030425151344     | Man excitation in Y (Rigid&Rotating) | Modified             | 4" spacer       | Open                 | Open                 |
| 68 | 030425152559     | Man excitation in X (Rigid&Rotating) | Modified             | 4" spacer       | Open                 | Open                 |
| 69 | 030425153216     | Man excitation in X (Jaw)            | Modified             | 4" spacer       | Open                 | Open                 |
| 70 | 030425153347     | Man excitation in Y (Jaw)            | Modified             | 4" spacer       | Open                 | Open                 |
| 71 | 030425155805     | Man excitation in X (Blade)          | Modified             | 4" spacer       | Open                 | Open                 |
| 72 | 030425160003     | Man excitation in Y (Blade)          | Modified             | 4" spacer       | Open                 | Open                 |

**Static Pull-Back and Free Vibration Test for Modified Switch on Full-Length Supports: 05/06/2003**

|    | <b>File Name</b> | <b>Signal name\Test</b>             | <b>Switch Design</b> | <b>Mounting</b> | <b>Main Blade</b> | <b>Ground Switch</b> |
|----|------------------|-------------------------------------|----------------------|-----------------|-------------------|----------------------|
| 73 | 030506085536     | Pullback test in X direction@500lbs | Modified             | 14' Support     | Closed            | Open                 |

**Table B.1. List of all tests performed from 03/25/2003 to 05/28/2003 (continued).**

|    | <b>File Name</b> | <b>Signal name\Test</b>             | <b>Strain gages</b> | <b>Gage Location</b> |        |      |
|----|------------------|-------------------------------------|---------------------|----------------------|--------|------|
| 74 | 030506103627     | Pullback test in Y direction@500lbs | Modified            | 14' Support          | Closed | Open |
| 75 | 030506143402     | Man excitation in X direction       | Modified            | 14' Support          | Closed | Open |
| 76 | 030506143934     | Man excitation in Y direction       | Modified            | 14' Support          | Closed | Open |

**Dynamic Tests of Modified Switch Mounted on 14' Supports; Blade closed: 05/07/2003**

|    | <b>File Name</b> | <b>Signal name\Test</b> | <b>Switch Design</b> | <b>Mounting</b> | <b>Main Blade</b> | <b>Ground Switch</b> |
|----|------------------|-------------------------|----------------------|-----------------|-------------------|----------------------|
| 77 | 030507100920     | Random in X direction   | Modified             | 14' Support     | Closed            | Open                 |
| 78 | 030507104414     | Random in Y direction   | Modified             | 14' Support     | Closed            | Open                 |
| 79 | 030507103710     | Random in Z direction   | Modified             | 14' Support     | Closed            | Open                 |
| 80 | 030507134125     | Sweep24 in X direction  | Modified             | 14' Support     | Closed            | Open                 |
| 81 | 030507140115     | Sweep24 in Y direction  | Modified             | 14' Support     | Closed            | Open                 |
| 82 | 030507140924     | Sweep24 in Z direction  | Modified             | 14' Support     | Closed            | Open                 |
| 83 | 030507142414     | Landers5L@0.125g        | Modified             | 14' Support     | Closed            | Open                 |
| 84 | 030507144116     | Landers5L@0.25g         | Modified             | 14' Support     | Closed            | Open                 |
| 85 | 030507152023     | CERL@0.25g              | Modified             | 14' Support     | Closed            | Open                 |

**Dynamic Tests of Modified Switch Mounted on 14' Supports; Blade closed: 05/08/2003**

|    | <b>File Name</b> | <b>Signal name\Test</b> | <b>Switch Design</b> | <b>Mounting</b> | <b>Main Blade</b> | <b>Ground Switch</b> |
|----|------------------|-------------------------|----------------------|-----------------|-------------------|----------------------|
| 86 | 030508122001     | Landers5L@0.125g        | Modified             | 14' Support     | Closed            | Open                 |
| 87 | 030508124144     | Landers5L@0.5g          | Modified             | 14' Support     | Closed            | Open                 |

**Pullback tests of Modified Switch Mounted on 14' Supports; Blade replaced by dummy mass: 05/09/2003**

|    | <b>File Name</b> | <b>Signal name\Test</b>      | <b>Switch Design</b> | <b>Mounting</b> | <b>Main Blade</b> | <b>Ground Switch</b> |
|----|------------------|------------------------------|----------------------|-----------------|-------------------|----------------------|
| 88 | 030509141030     | Stiffness X (Rigid&Rotating) | Modified             | 14' Support     | Removed           | Open                 |
| 89 | 030509155710     | Stiffness Y (Rigid&Rotating) | Modified             | 14' Support     | Removed           | Open                 |



**Table B.1. List of all tests performed from 03/25/2003 to 05/28/2003 (continued).**

|    | <b>File Name</b> | <b>Signal name\Test</b> | <b>Strain gages</b> | <b>Gage Location</b> |         |      |
|----|------------------|-------------------------|---------------------|----------------------|---------|------|
| 90 | 030509145357     | Stiffness X (Jaw)       | Modified            | 14' Support          | Removed | Open |
| 91 | 030509160459     | Stiffness Y (Jaw)       | Modified            | 14' Support          | Removed | Open |
|    |                  |                         |                     |                      |         |      |

**Dynamic Tests of Modified Switch Mounted on 14' Supports; Blade removed: 05/12/2003**

|     | <b>File Name</b> | <b>Signal name\Test</b>              | <b>Switch Design</b> | <b>Mounting</b> | <b>Main Blade</b> | <b>Ground Switch</b> |
|-----|------------------|--------------------------------------|----------------------|-----------------|-------------------|----------------------|
| 92  | 030512084123     | Man excitation in X (Rigid&Rotating) | Modified             | 14' Support     | Removed           | Open                 |
| 93  | 030512085756     | Man excitation in Y (Rigid&Rotating) | Modified             | 14' Support     | Removed           | Open                 |
| 94  | 030512090009     | Man excitation in X (Jaw)            | Modified             | 14' Support     | Removed           | Open                 |
| 95  | 030512090159     | Man excitation in Y (Jaw)            | Modified             | 14' Support     | Removed           | Open                 |
| 96  | 030512090521     | Man excitation in X (Jaw)            | Modified             | 14' Support     | Removed           | Closed               |
| 97  | 030512090640     | Man excitation in Y (Jaw)            | Modified             | 14' Support     | Removed           | Closed               |
| 98  | 030512100336     | Random in X direction                | Modified             | 14' Support     | Removed           | Open                 |
| 99  | 030512101051     | Random in Y direction                | Modified             | 14' Support     | Removed           | Open                 |
| 100 | 030512101205     | Random in Z direction                | Modified             | 14' Support     | Removed           | Open                 |
| 101 | 030512110613     | Sweep24 in X direction               | Modified             | 14' Support     | Removed           | Open                 |
| 102 | 030512111952     | Sweep24 in Y direction               | Modified             | 14' Support     | Removed           | Open                 |
| 103 | 030512112301     | Sweep24 in Z direction               | Modified             | 14' Support     | Removed           | Open                 |
| 104 | 030512113839     | Random in X direction                | Modified             | 14' Support     | Removed           | Closed               |
| 105 | 030512114023     | Random in Y direction                | Modified             | 14' Support     | Removed           | Closed               |
| 106 | 030512114145     | Random in Z direction                | Modified             | 14' Support     | Removed           | Closed               |
| 107 | 030512114614     | Sweep24 in X direction               | Modified             | 14' Support     | Removed           | Closed               |
| 108 | 030512114937     | Sweep24 in Y direction               | Modified             | 14' Support     | Removed           | Closed               |
| 109 | 030512115803     | Sweep24 in Z direction               | Modified             | 14' Support     | Removed           | Closed               |

**Table B.1. List of all tests performed from 03/25/2003 to 05/28/2003 (continued).****Dynamic Tests of Modified Switch Mounted on 14' Supports; Blade removed (GSW open): 05/12/2003**

|     | File Name    | Signal name\Test | Switch Design | Mounting    | Main Blade | Ground Switch |
|-----|--------------|------------------|---------------|-------------|------------|---------------|
| 110 | 030512124245 | Landers5L@0.125g | Modified      | 14' Support | Removed    | Open          |
| 111 | 030512142536 | Landers5L@0.25g  | Modified      | 14' Support | Removed    | Open          |
| 112 | 030512143921 | Landers5L@0.5g   | Modified      | 14' Support | Removed    | Open          |

**Dynamic Tests of Modified Switch Mounted on 14' Supports; Blade removed (GSW closed): 05/12/2003**

|     | File Name    | Signal name\Test | Switch Design | Mounting    | Main Blade | Ground Switch |
|-----|--------------|------------------|---------------|-------------|------------|---------------|
| 113 | 030512151835 | Landers5L@0.125g | Modified      | 14' Support | Removed    | Closed        |
| 114 | 030512152035 | Landers5L@0.25g  | Modified      | 14' Support | Removed    | Closed        |
| 115 | 030512152232 | Landers5L@0.5g   | Modified      | 14' Support | Removed    | Closed        |

**Dynamic Tests of Modified Switch Mounted on 14' Supports; Blade removed (GSW closed: Restest): 05/13/2003**

|     | File Name    | Signal name\Test | Switch Design | Mounting    | Main Blade | Ground Switch |
|-----|--------------|------------------|---------------|-------------|------------|---------------|
| 116 | 030513114033 | Landers5L@0.125g | Modified      | 14' Support | Removed    | Closed        |
| 117 | 030513114305 | Landers5L@0.25g  | Modified      | 14' Support | Removed    | Closed        |
| 118 | 030513114511 | Landers5L@0.5g   | Modified      | 14' Support | Removed    | Closed        |

**Dynamic Tests of Modified Switch Mounted on 14' Supports; Blade closed: 05/15/2003**

|     | File Name    | Signal name\Test    | Switch Design | Mounting    | Main Blade | Ground Switch |
|-----|--------------|---------------------|---------------|-------------|------------|---------------|
| 119 | 030515102324 | Landers5L@0.125g    | Modified      | 14' Support | Closed     | Open          |
| 120 | 030515103702 | Landers5L@0.25g     | Modified      | 14' Support | Closed     | Open          |
| 121 | 030515120814 | Landers5L@0.5g      | Modified      | 14' Support | Closed     | Open          |
| 122 | 030515124835 | Landers5H@0.75g     | Modified      | 14' Support | Closed     | Open          |
| 123 | 030515150039 | Landers5H@1.0g (PL) | Modified      | 14' Support | Closed     | Open          |

**Table B.1. List of all tests performed from 03/25/2003 to 05/28/2003 (continued).****Dynamic and Free-Vibration Tests of Modified Switch Mounted on 4" Spacer; Blade closed: 05/19/2003**

|     | <b>File Name</b> | <b>Signal name\Test</b>              | <b>Switch Design</b> | <b>Mounting</b> | <b>Main Blade</b> | <b>Ground Switch</b> |
|-----|------------------|--------------------------------------|----------------------|-----------------|-------------------|----------------------|
| 124 | 030519100141     | Random in X direction                | Modified             | 4" spacer       | Closed            | Open                 |
| 125 | 030519100254     | Random in Y direction                | Modified             | 4" spacer       | Closed            | Open                 |
| 126 | 030519100353     | Random in Z direction                | Modified             | 4" spacer       | Closed            | Open                 |
| 127 | 030519102013     | Sweep24 in X direction               | Modified             | 4" spacer       | Closed            | Open                 |
| 128 | 030519102307     | Sweep24 in Y direction               | Modified             | 4" spacer       | Closed            | Open                 |
| 129 | 030519102652     | Sweep24 in Z direction               | Modified             | 4" spacer       | Closed            | Open                 |
| 130 | 030519111046     | Landers5L@0.25g                      | Modified             | 4" spacer       | Closed            | Open                 |
| 131 | 030519104714     | Landers5L@0.5g                       | Modified             | 4" spacer       | Closed            | Open                 |
| 132 | 0305191120651    | Man excitation in X                  | Modified             | 4" spacer       | Closed            | Open                 |
| 133 | 030519120927     | Man excitation in Y                  | Modified             | 4" spacer       | Closed            | Open                 |
| 134 | 030519121645     | Man excitation in X (Jaw)            | Modified             | 4" spacer       | Open              | Open                 |
| 135 | 030519121501     | Man excitation in Y (Jaw)            | Modified             | 4" spacer       | Open              | Open                 |
| 136 | 030519121928     | Man excitation in X (Jaw)            | Modified             | 4" spacer       | Open              | Closed               |
| 137 | 0305191212018    | Man excitation in Y (Jaw)            | Modified             | 4" spacer       | Open              | Closed               |
| 138 | 030519123020     | Man excitation in X (Blade)          | Modified             | 4" spacer       | Open              | Closed               |
| 139 | 030519123228     | Man excitation in Y (Blade)          | Modified             | 4" spacer       | Open              | Closed               |
| 140 | 030519123537     | Man excitation in X (Rigid&Rotating) | Modified             | 4" spacer       | Open              | Closed               |
| 141 | 030519123650     | Man excitation in Y (Rigid&Rotating) | Modified             | 4" spacer       | Open              | Closed               |
| 142 | missing          | Random in X direction                | Modified             | 4" spacer       | Open              | Closed               |
| 143 | 030519134145     | Random in Y direction                | Modified             | 4" spacer       | Open              | Closed               |
| 144 | 030519134340     | Random in Z direction                | Modified             | 4" spacer       | Open              | Closed               |
| 145 | 030519134808     | Sweep24 in X direction               | Modified             | 4" spacer       | Open              | Closed               |
| 146 | 030519135102     | Sweep24 in Y direction               | Modified             | 4" spacer       | Open              | Closed               |
| 147 | 030519135359     | Sweep24 in Z direction               | Modified             | 4" spacer       | Open              | Closed               |
| 148 | 030519140246     | Random in X direction                | Modified             | 4" spacer       | Open              | Open                 |

**Table B.1. List of all tests performed from 03/25/2003 to 05/28/2003 (continued).**

|     | <b>File Name</b> | <b>Signal name\Test</b> | <b>Strain gages</b> | <b>Gage Location</b> |        |      |
|-----|------------------|-------------------------|---------------------|----------------------|--------|------|
| 149 | 030519140356     | Random in Y direction   | Modified            | 4" spacer            | Open   | Open |
| 150 | 030519140521     | Random in Z direction   | Modified            | 4" spacer            | Open   | Open |
| 151 | 030519141003     | Sweep24 in X direction  | Modified            | 4" spacer            | Open   | Open |
| 152 | 030519141250     | Sweep24 in Y direction  | Modified            | 4" spacer            | Open   | Open |
| 153 | 030519141542     | Sweep24 in Z direction  | Modified            | 4" spacer            | Open   | Open |
| 154 | 030519151233     | Landers3@0.25g          | Modified            | 4" spacer            | Closed | Open |
| 155 | 030519152926     | Landers3@0.5g           | Modified            | 4" spacer            | Closed | Open |
| 156 | 030519163549     | Landers5H@0.5g          | Modified            | 4" spacer            | Closed | Open |
| 157 | 030519164554     | Landers5H@0.6g          | Modified            | 4" spacer            | Closed | Open |

**Dynamic Tests of Modified Switch Mounted on 4" Spacer; Blade open: 05/20/2003**

|     | <b>File Name</b> | <b>Signal name\Test</b> | <b>Switch Design</b> | <b>Mounting</b> | <b>Main Blade</b> | <b>Ground Switch</b> |
|-----|------------------|-------------------------|----------------------|-----------------|-------------------|----------------------|
| 158 | 030520120634     | Random in X direction   | Modified             | 4" spacer       | Open              | Closed               |
| 159 | 030520120736     | Random in Y direction   | Modified             | 4" spacer       | Open              | Closed               |
| 160 | 030520120844     | Random in Z direction   | Modified             | 4" spacer       | Open              | Closed               |
| 161 | 030520123032     | Landers5H@0.5g          | Modified             | 4" spacer       | Open              | Closed               |
| 162 | 030520125337     | Landers5H@0.85g         | Modified             | 4" spacer       | Open              | Closed               |
| 163 | 030520132259     | Landers5H@1.0g          | Modified             | 4" spacer       | Open              | Closed               |
| 164 | 030520141531     | Landers5H@1.17g         | Modified             | 4" spacer       | Open              | Closed               |
| 165 | 030520143037     | Random in X direction   | Modified             | 4" spacer       | Open              | Closed               |
| 166 | 030520143143     | Random in Y direction   | Modified             | 4" spacer       | Open              | Closed               |
| 167 | 030520143252     | Random in Z direction   | Modified             | 4" spacer       | Open              | Closed               |
| 168 | 030520143714     | Sweep24 in X direction  | Modified             | 4" spacer       | Open              | Closed               |
| 169 | 030520144001     | Sweep24 in Y direction  | Modified             | 4" spacer       | Open              | Closed               |
| 170 | 030520144239     | Sweep24 in Z direction  | Modified             | 4" spacer       | Open              | Closed               |

**Table B.1. List of all tests performed from 03/25/2003 to 05/28/2003 (continued).****Static and Free-Vibration Tests for Full-Length Support without Leveling Bolts (West): 05/23/2003**

|     | File Name    | Signal name\Test                    | Strain gages | Gage Location    |
|-----|--------------|-------------------------------------|--------------|------------------|
| 171 | 030523105635 | Pullback test in X direction@300lbs | 5-8          | West 14' Support |
| 172 | 030523111547 | Man excitation in X direction       | 5-8          | West 14' Support |

**Free-Vibration and Fragility Tests for Rotating Insulator Post: 05/27/2003**

|     | File Name    | Signal name\Test              | Strain gages | Gage Location           |
|-----|--------------|-------------------------------|--------------|-------------------------|
| 173 | 030527130701 | Man excitation in X direction | 13-16        | Rotating Insulator Post |
| 174 | 030527130739 | Man excitation in Y direction | 13-16        | Rotating Insulator Post |
| 175 | 030527152716 | Fragility test in X direction | 13-16        | Rotating Insulator Post |

**Free-Vibration and Fragility Tests for Rigid and Jaw Insulator Posts: 05/28/2003**

|     | File Name    | Signal name\Test              | Strain gages       | Gage Location        |
|-----|--------------|-------------------------------|--------------------|----------------------|
| 176 | 030528104849 | Man excitation in X direction | 9-12, 25-28, 29-34 | Rigid Insulator Post |
| 177 | 030528105049 | Man excitation in Y direction | 9-12, 25-28, 29-34 | Rigid Insulator Post |
| 178 | 030528311501 | Fragility test in X direction | 9-12, 25-28, 29-34 | Rigid Insulator Post |
| 179 | 030528145353 | Man excitation in X direction | 17-20, 21-24       | Jaw Insulator Post   |
| 180 | 030528145507 | Man excitation in Y direction | 17-20, 21-24       | Jaw Insulator Post   |
| 181 | 030528152311 | Fragility test in X direction | 17-20, 21-24       | Jaw Insulator Post   |

## Appendix C Resonance Search for Support and Spacer Mounted Configurations used in Qualification Study

The appendix presents plots for resonance search conducted for the support mounted and spacer mounted Modified Switch used in the qualification study.

The resonance search was conducted with sine-sweep signal and a typical power spectral density (PSD) of acceleration data recorded at the table level is presented in Fig. C.1.

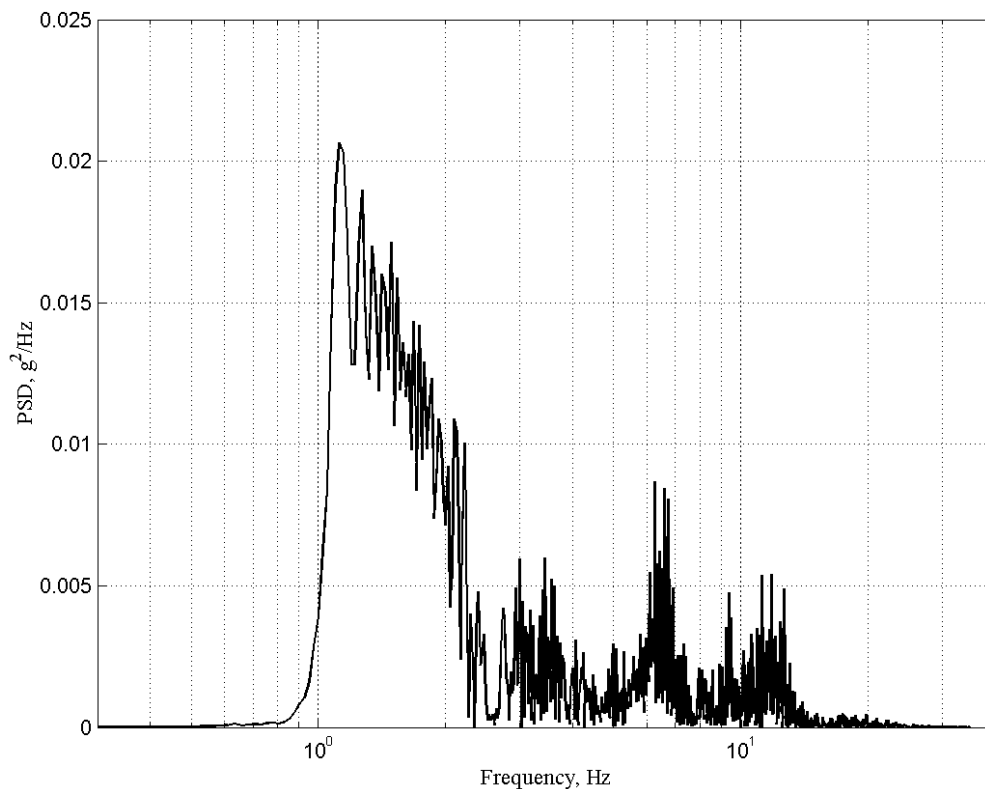


Fig. C.1. Typical PSD of acceleration data recorded at table level.

The resonance search results for the support mounted switch with the main blade closed and the grounding blade open are presented in Figs. C.2 – C.4. The plots present acceleration PSD at two levels: at the level corresponding to the top of the support legs and at the top of insulator posts. Figures C.5 – C. 7 show the resonance search results for the spacer mounted switch with the main blade open and the grounding blade closed. The plots present acceleration PSD at top of insulator posts and at the tip of main blade. The PSDs in low frequency range for vertical direction (Figs. C.4 and C.7) repeat the trend of the PSD at the table level (Fig. C.1), that reflects high stiffness of the switch in the vertical direction.

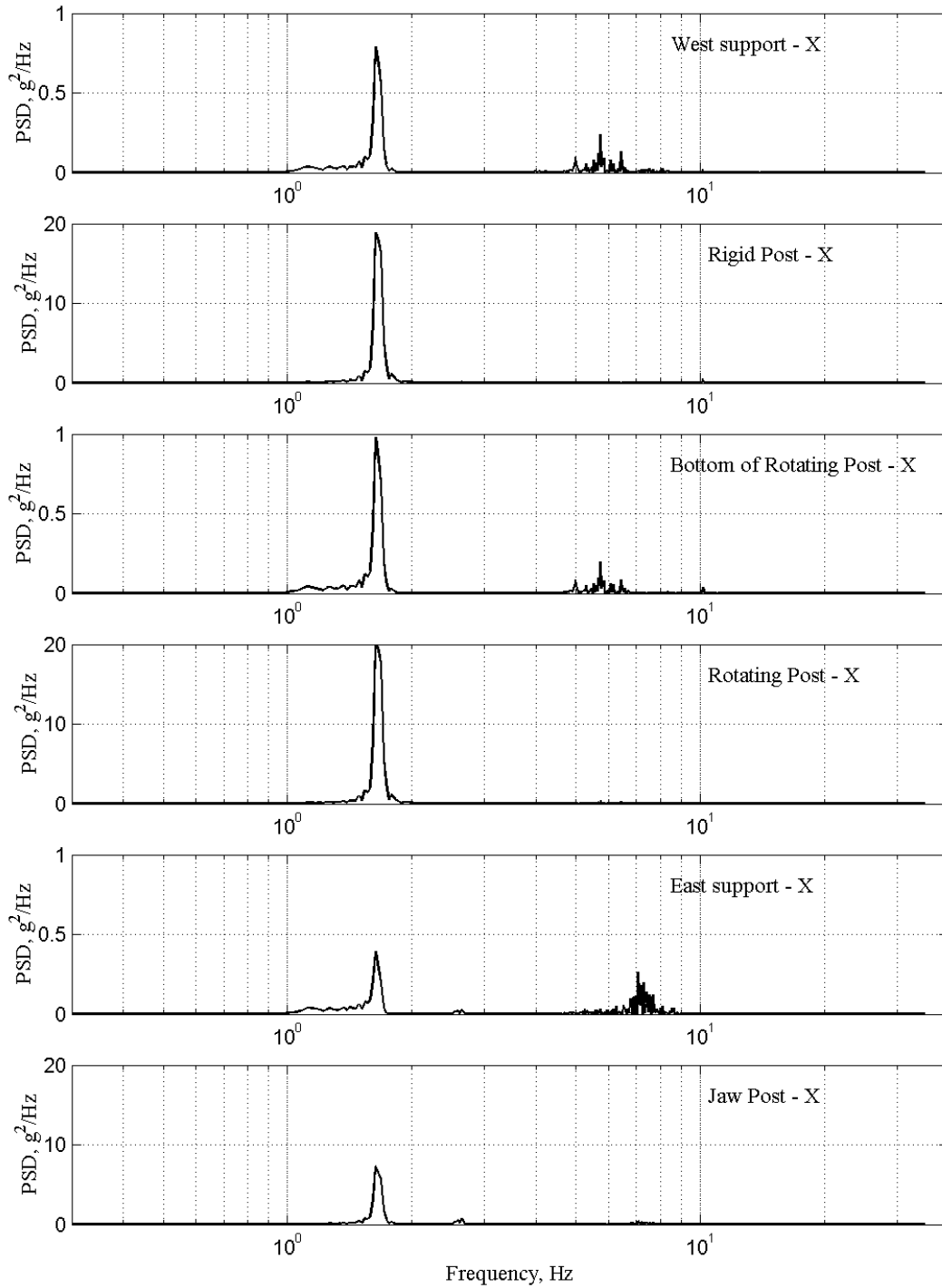


Fig. C.2. Resonance search results for support mounted switch in X direction.



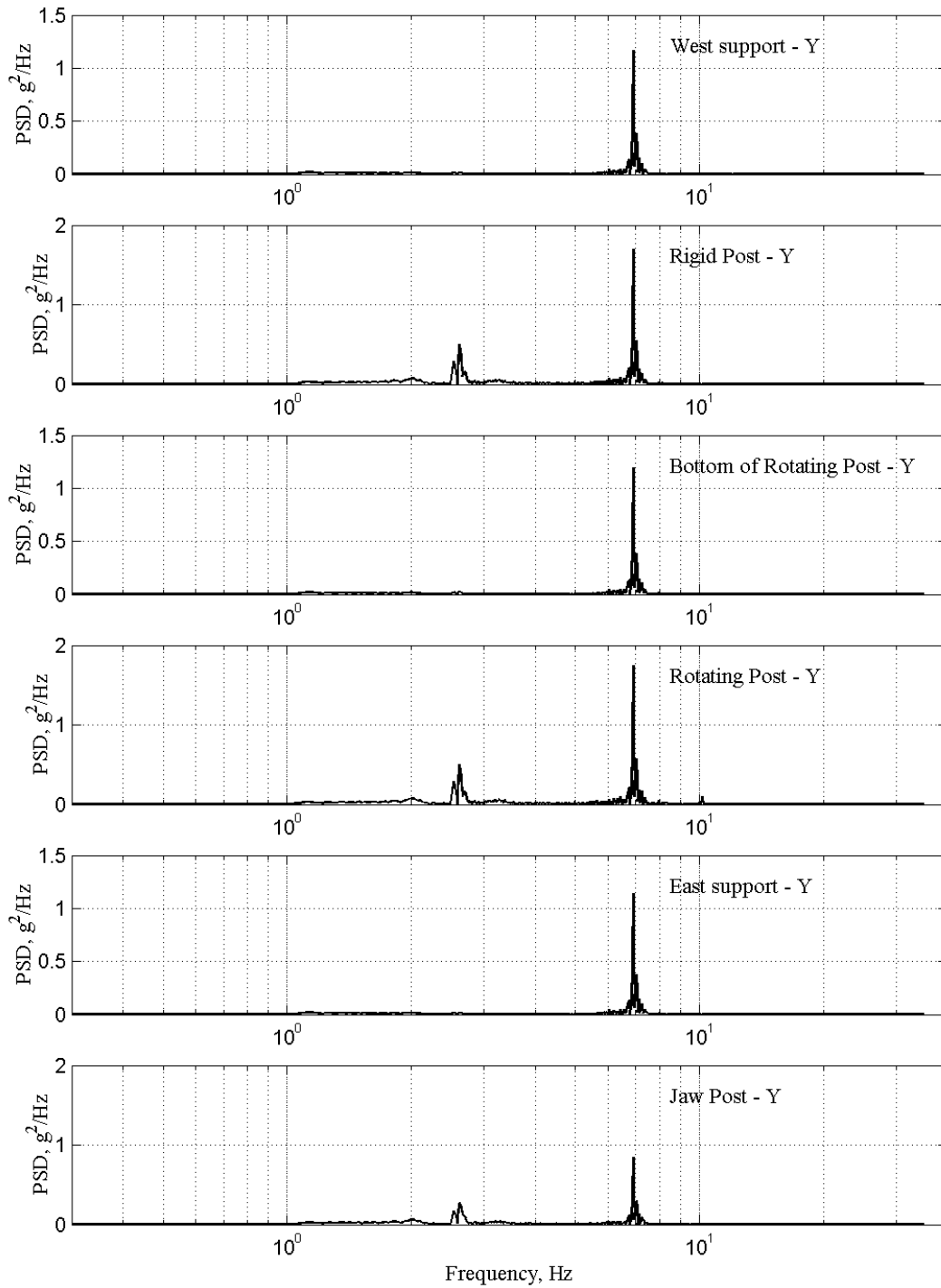


Fig. C.3. Resonance search results for support mounted switch in Y direction.

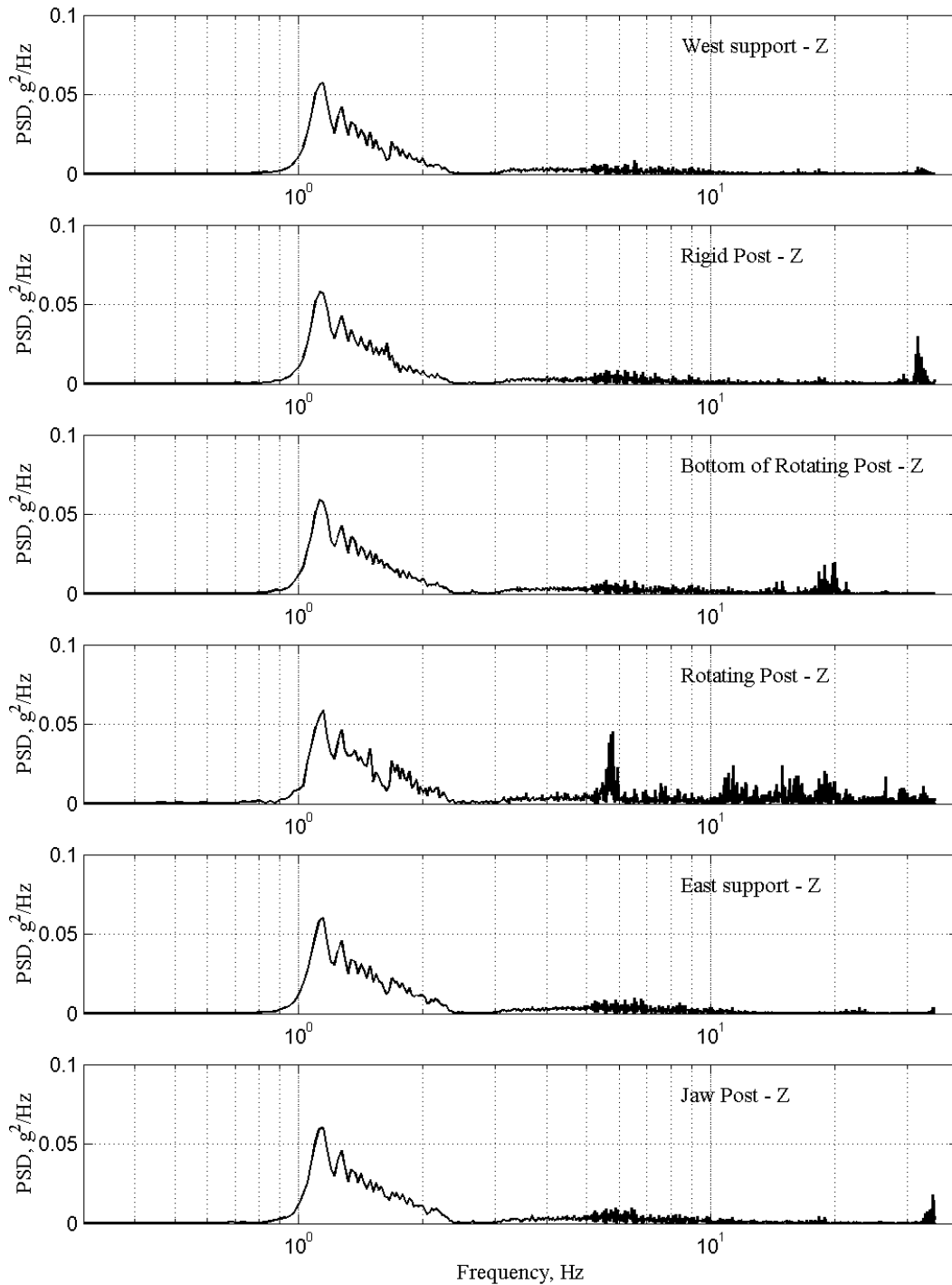


Fig. C.4. Resonance search results for support mounted switch in Z direction.

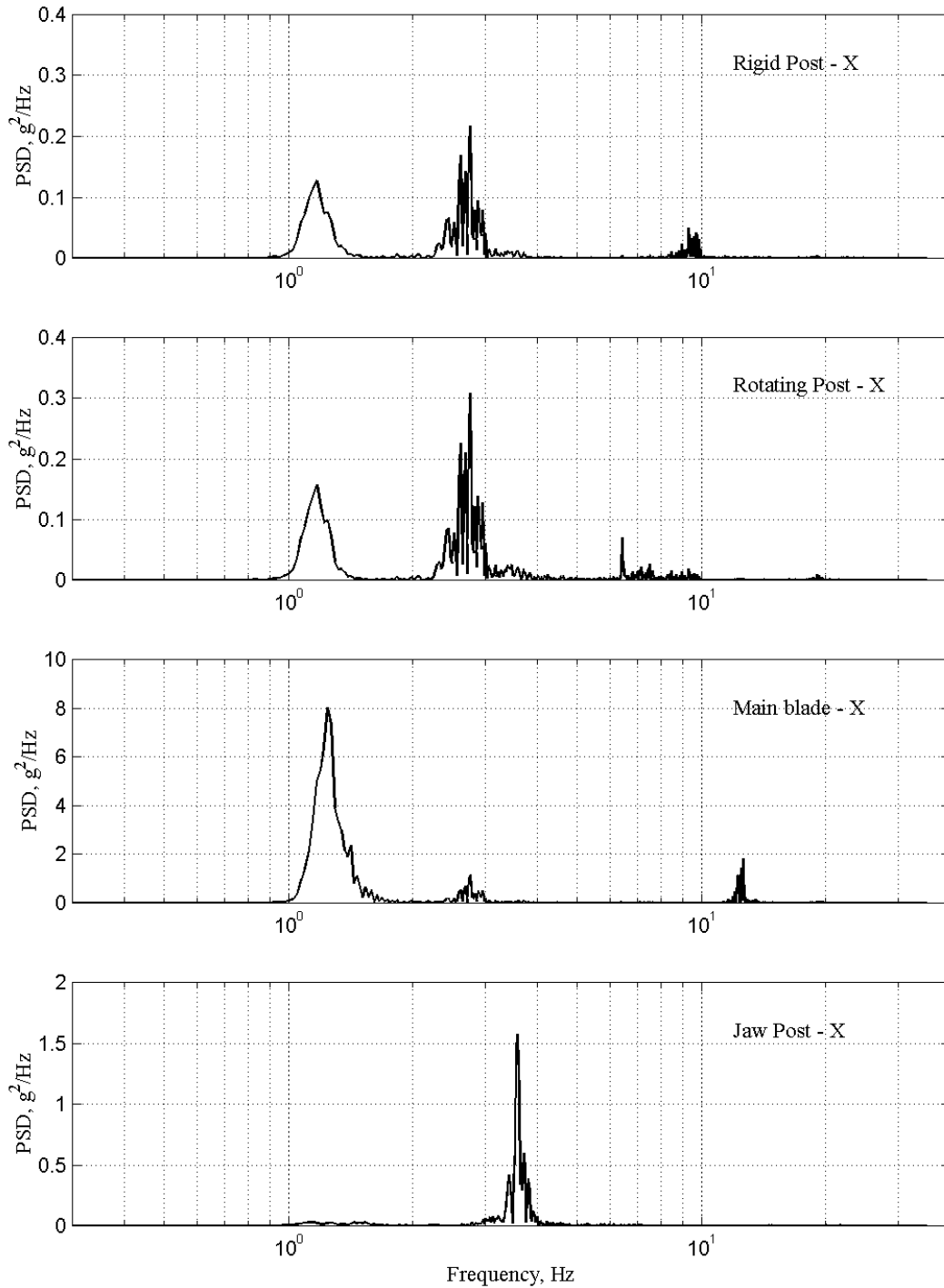


Fig. C.5. Resonance search results for spacer mounted switch in X direction.

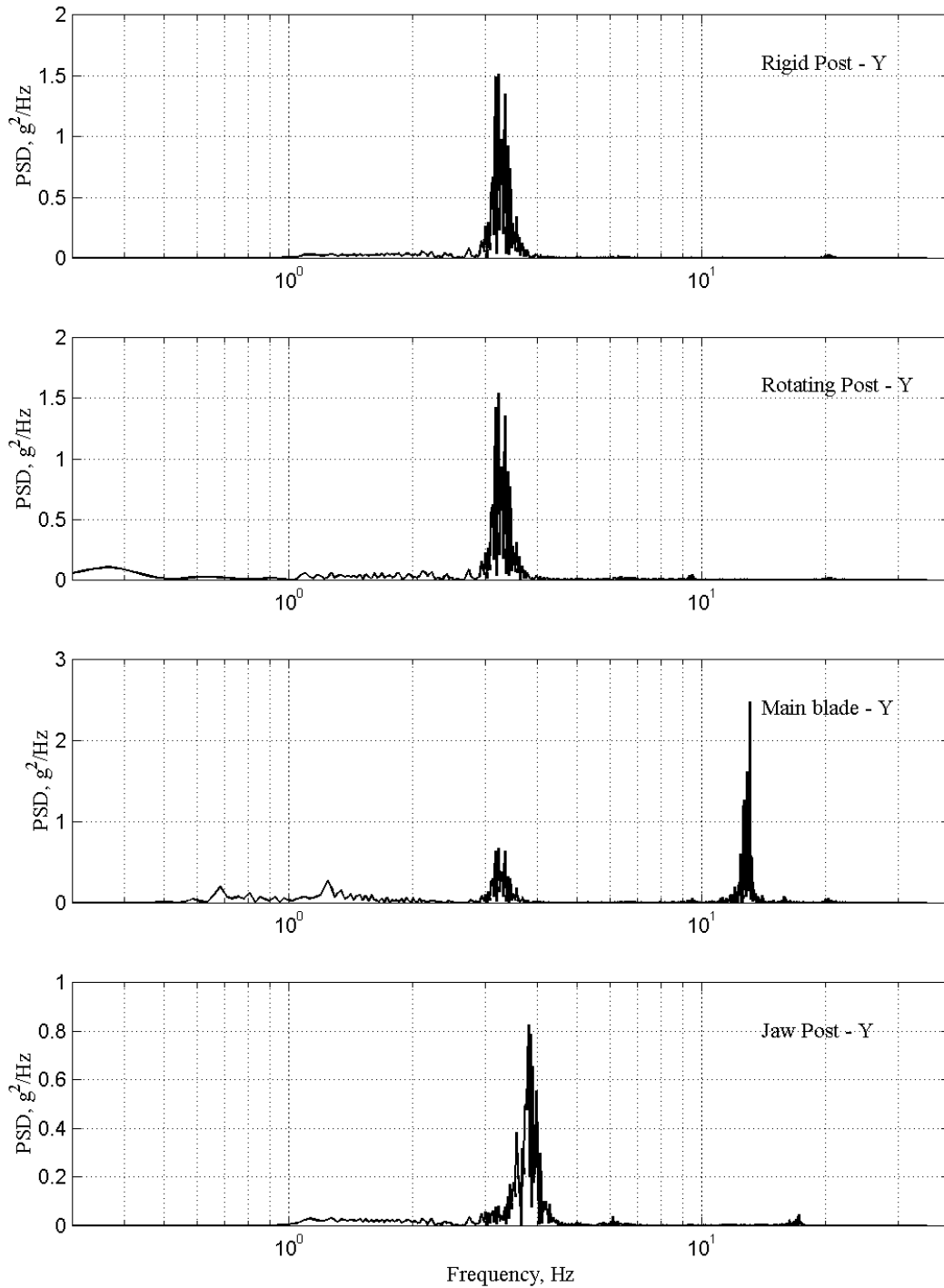


Fig. C.6. Resonance search results for spacer mounted switch in Y direction.

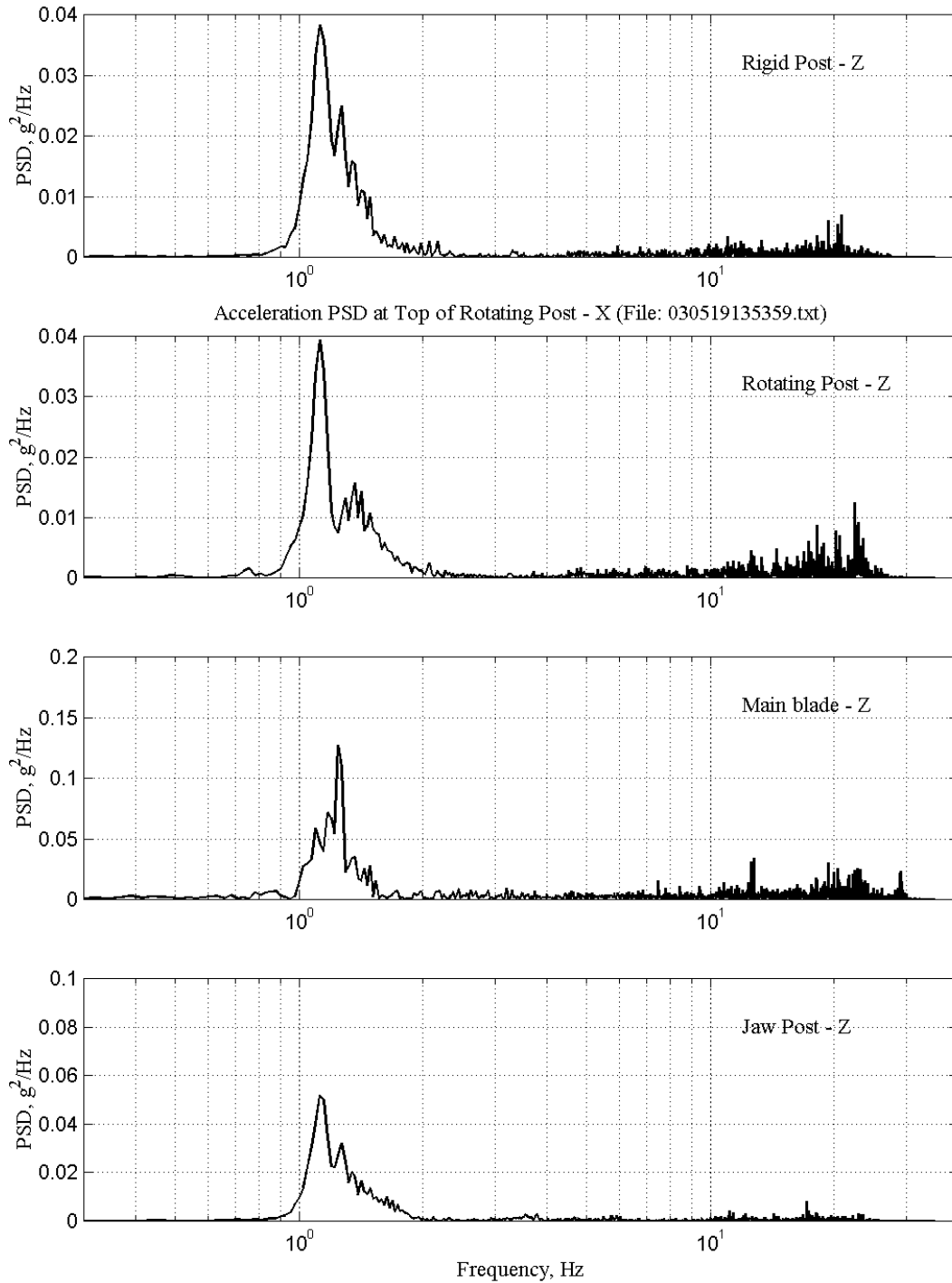


Fig. C.7. Resonance search results for spacer mounted switch in Z direction.